

65 Perrott Drive

Ground Floor

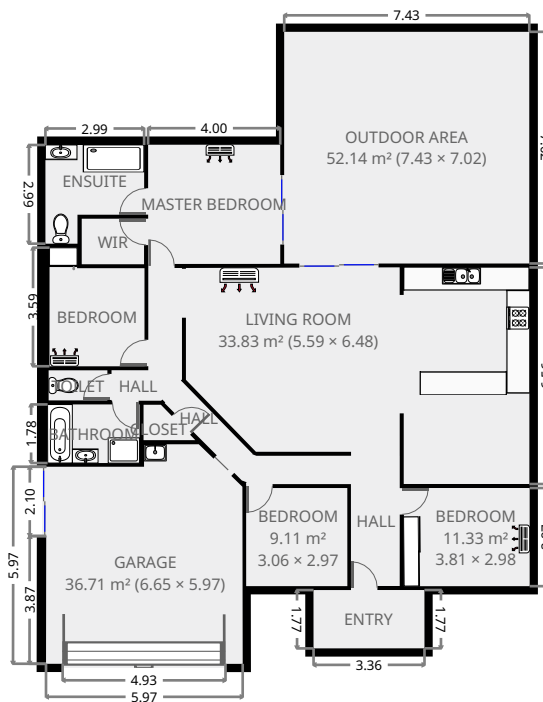

THIS FLOORPLAN IS PROVIDED WITHOUT WARRANTY OF ANY KIND. SENSOPIA DISCLAIMS ANY WARRANTY INCLUDING, WITHOUT LIMITATION, SATISFACTORY QUALITY OR ACCURACY OF DIMENSIONS.

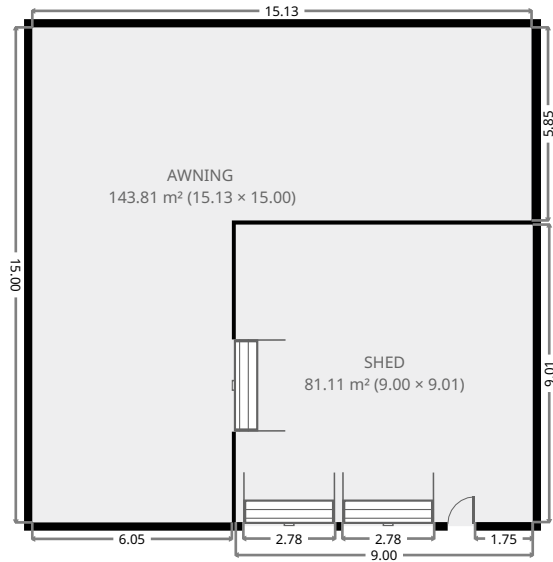
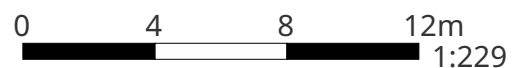

65 Perrott Drive

Bedroom

Width: 2.88 m
Length: 3.59 m
Area: 9.07 m²
Perimeter: 12.94 m

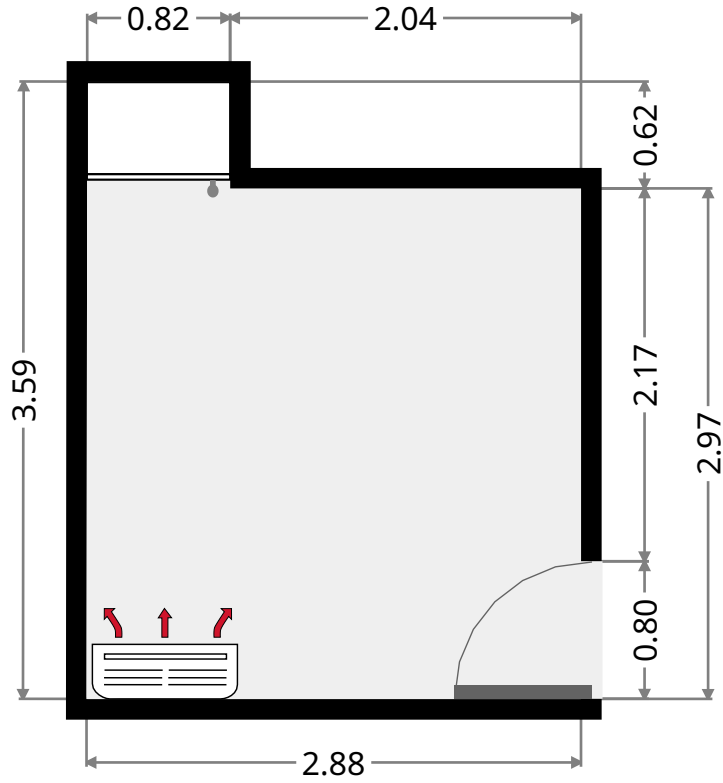
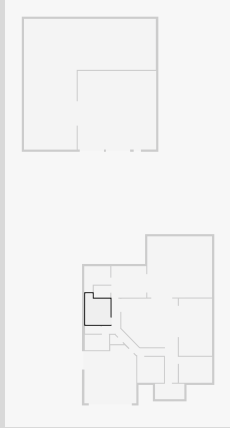

Entry

Width: 1.77 m
Length: 3.36 m
Area: 5.94 m²
Perimeter: 10.26 m

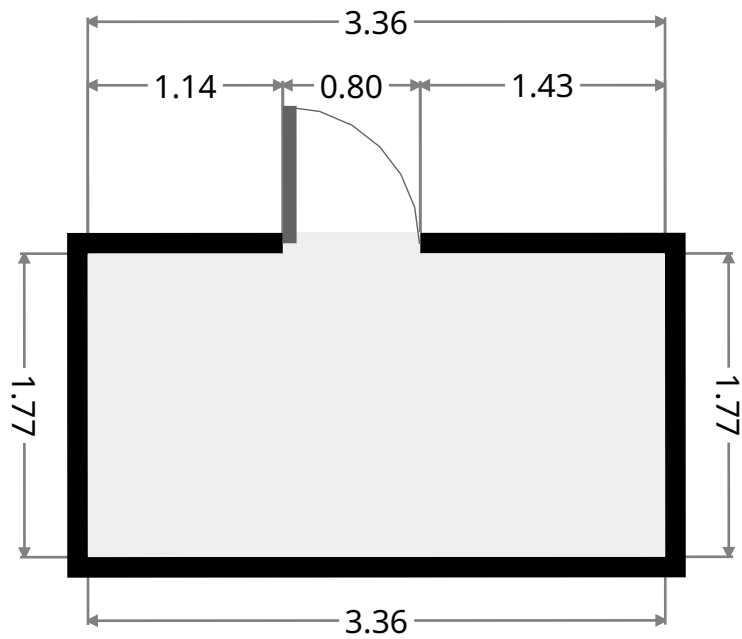
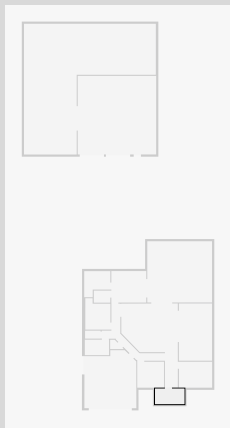

65 Perrott Drive

Awning

Width: 15.00 m
Length: 15.13 m
Area: 143.81 m²
Perimeter: 60.25 m

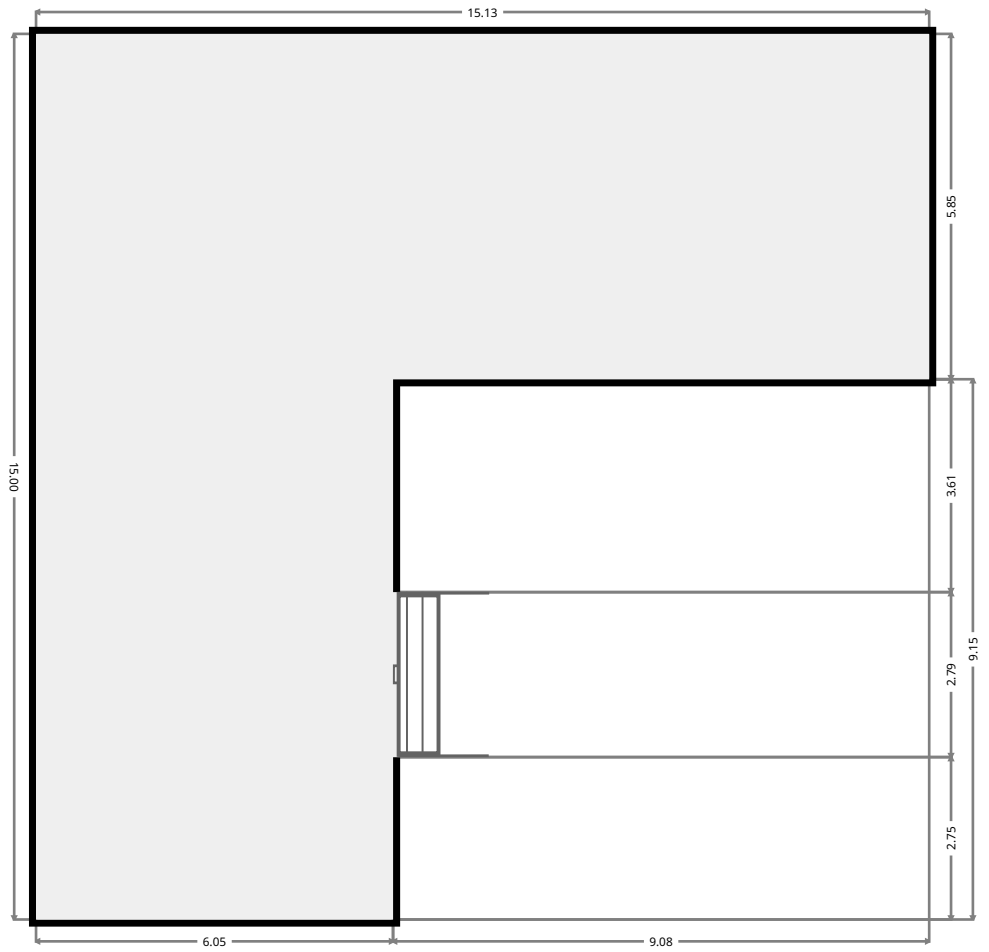
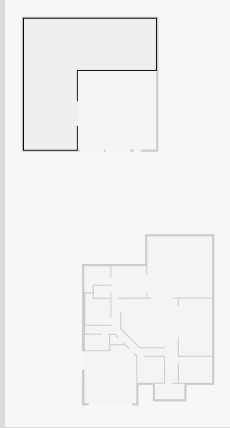

THIS FLOORPLAN IS PROVIDED WITHOUT WARRANTY OF ANY KIND. SENSOPIA DISCLAIMS ANY WARRANTY INCLUDING, WITHOUT LIMITATION, SATISFACTORY QUALITY OR ACCURACY OF DIMENSIONS.



65 Perrott Drive

Shed

Width: 9.00 m
 Length: 9.01 m
 Area: 81.11 m²
 Perimeter: 36.03 m

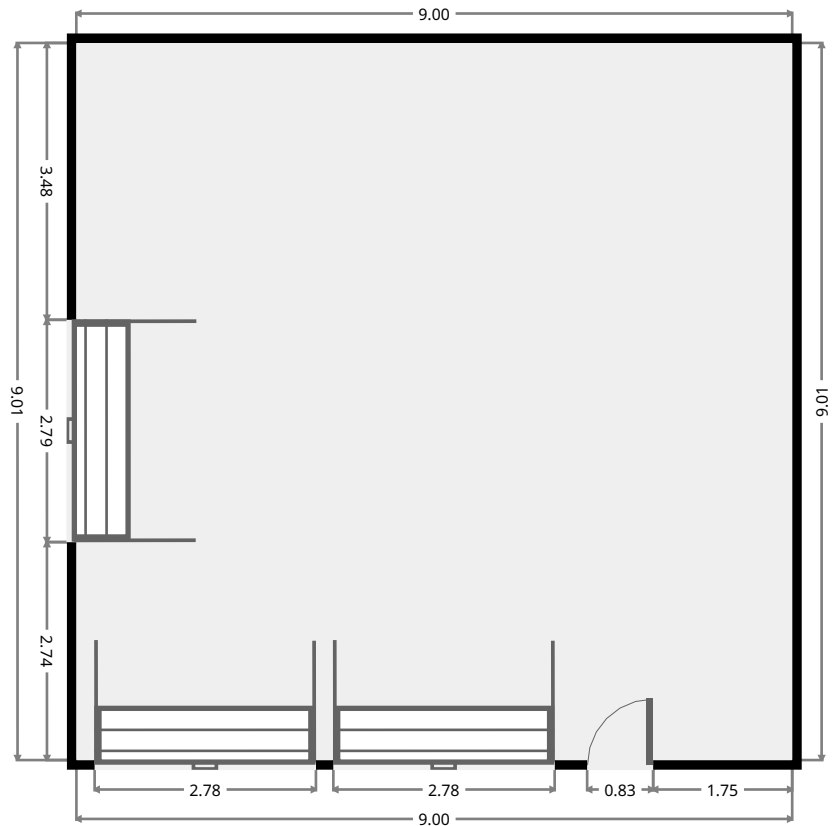
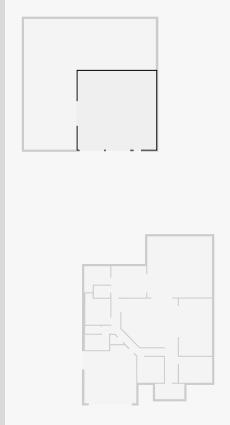

Outdoor Area

Width: 7.02 m
 Length: 7.43 m
 Area: 52.14 m²
 Perimeter: 28.89 m

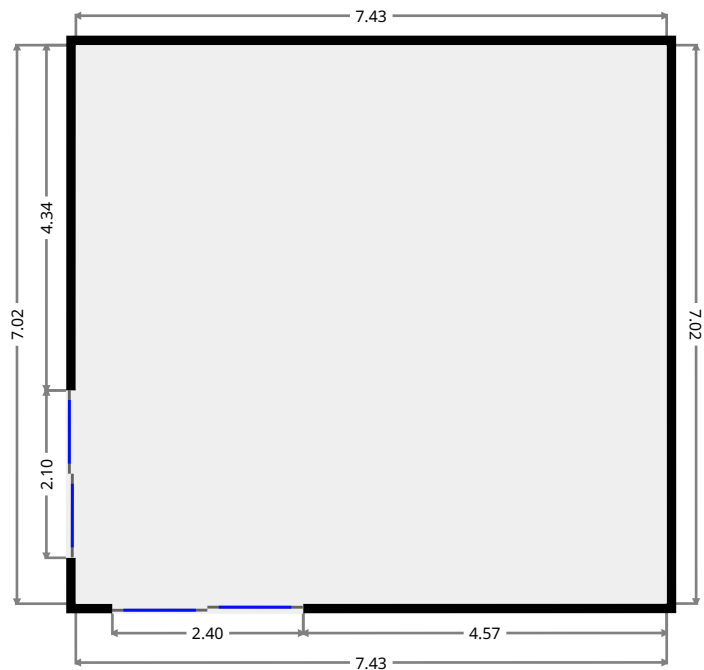
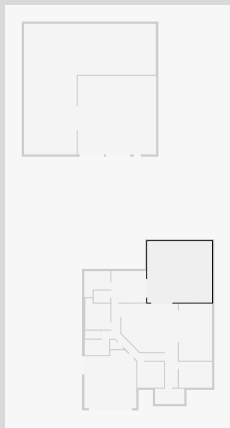

THIS FLOORPLAN IS PROVIDED WITHOUT WARRANTY OF ANY KIND. SENSOPIA DISCLAIMS ANY WARRANTY INCLUDING, WITHOUT LIMITATION, SATISFACTORY QUALITY OR ACCURACY OF DIMENSIONS.

65 Perrott Drive

Kitchen/Dining Room

Width: 3.81 m
 Length: 6.56 m
 Area: 24.98 m²
 Perimeter: 20.74 m

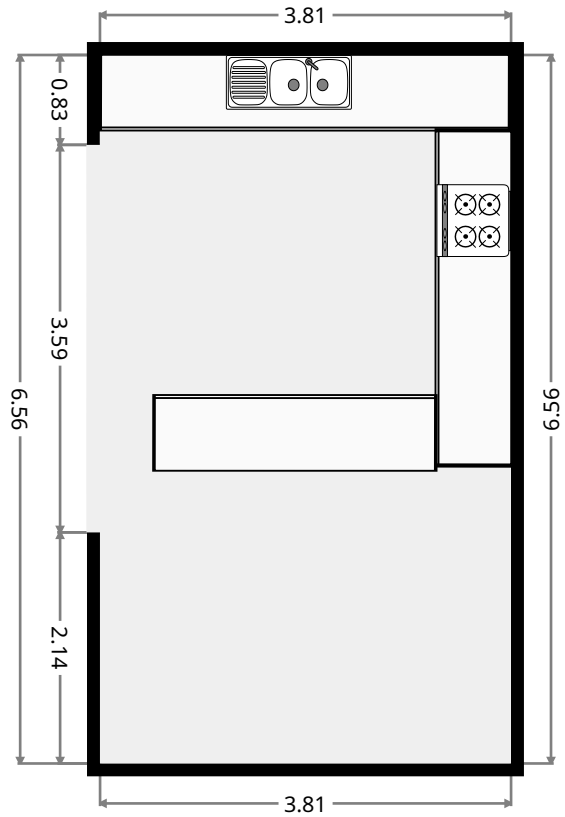
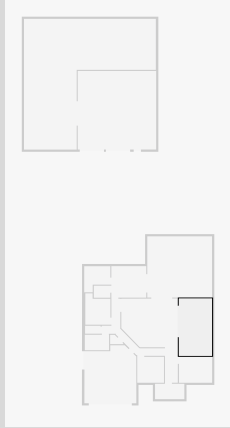

Living Room

Width: 5.59 m
 Length: 6.48 m
 Area: 33.83 m²
 Perimeter: 22.86 m
 Ceiling Height: 2.17 m

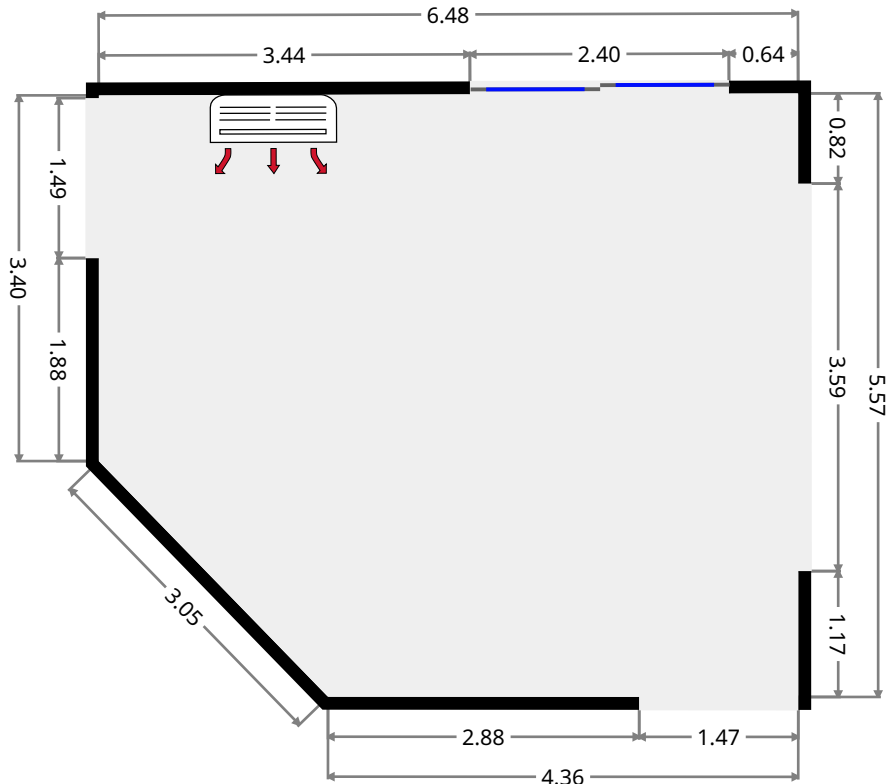
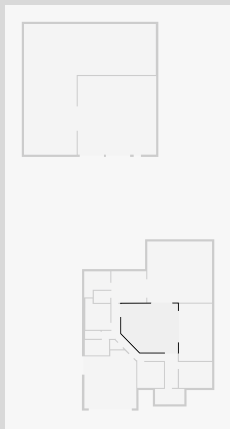

THIS FLOORPLAN IS PROVIDED WITHOUT WARRANTY OF ANY KIND. SENSOPIA DISCLAIMS ANY WARRANTY INCLUDING, WITHOUT LIMITATION, SATISFACTORY QUALITY OR ACCURACY OF DIMENSIONS.

65 Perrott Drive

Ensuite

Width: 2.99 m
 Length: 2.99 m
 Area: 7.17 m²
 Perimeter: 11.96 m

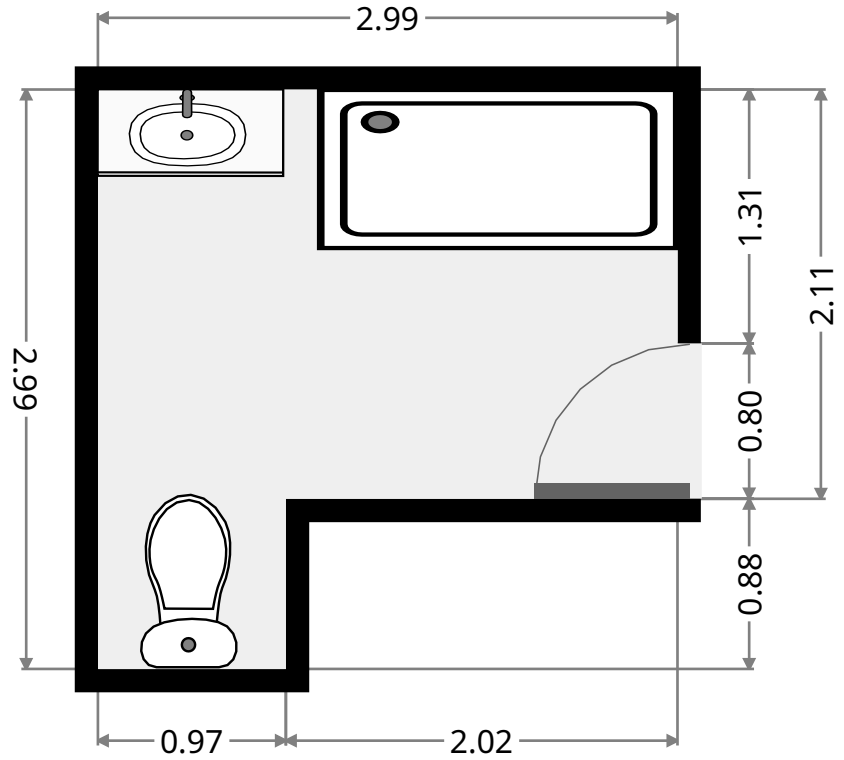
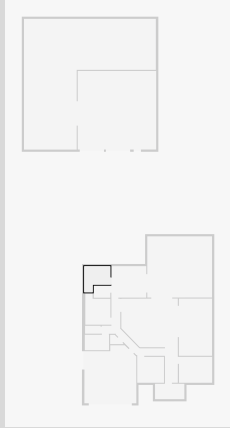

WIR

Width: 1.38 m
 Length: 1.89 m
 Area: 2.60 m²
 Perimeter: 6.54 m

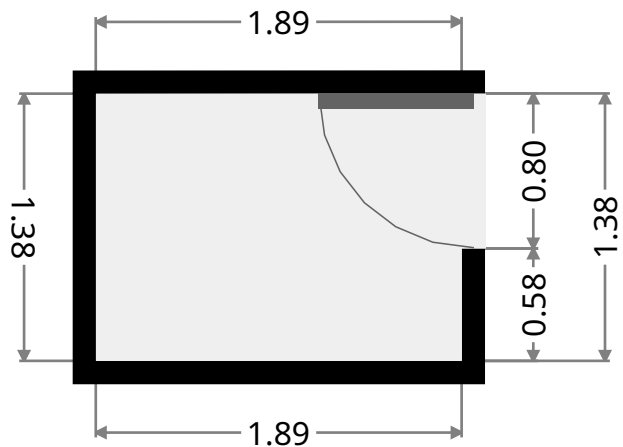
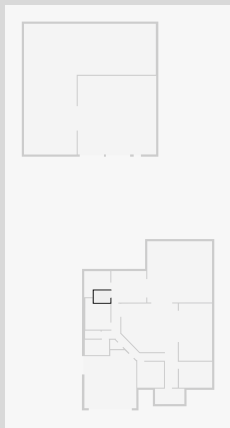

65 Perrott Drive

Master Bedroom

Width: 3.61 m
 Length: 4.00 m
 Area: 14.46 m²
 Perimeter: 15.23 m

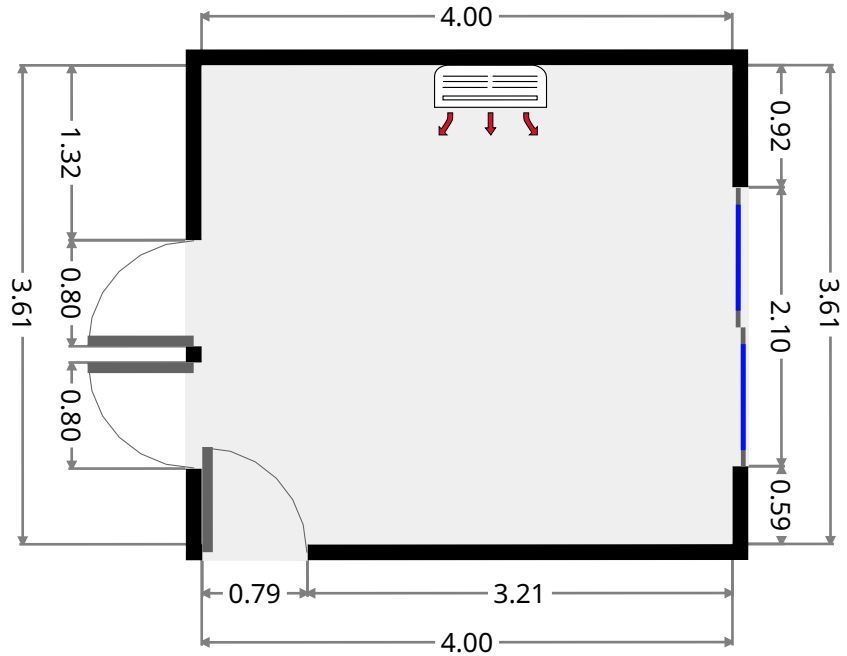
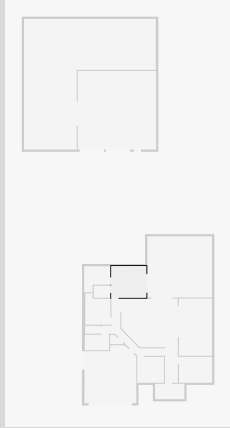

Hall

Width: 3.95 m
 Length: 4.66 m
 Area: 8.43 m²
 Perimeter: 16.96 m

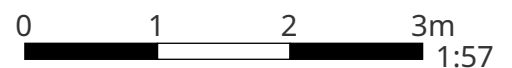
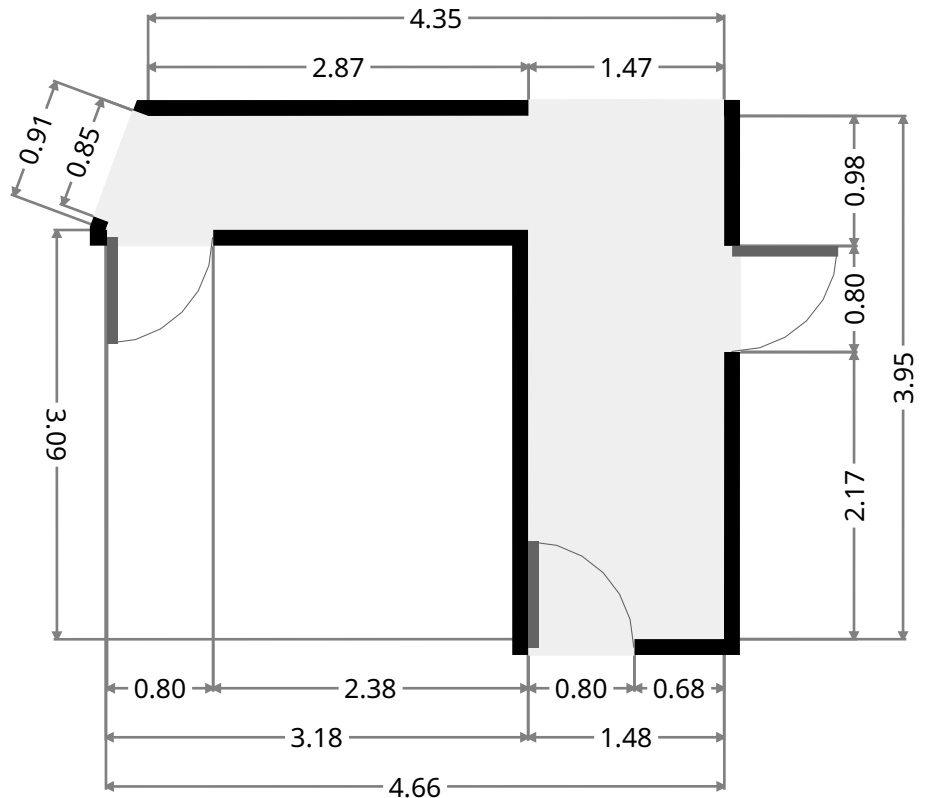
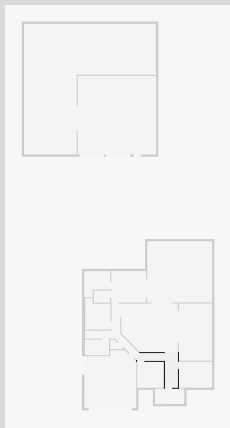

THIS FLOORPLAN IS PROVIDED WITHOUT WARRANTY OF ANY KIND. SENSOPIA DISCLAIMS ANY WARRANTY INCLUDING, WITHOUT LIMITATION, SATISFACTORY QUALITY OR ACCURACY OF DIMENSIONS.

65 Perrott Drive

Closet

Width: 1.07 m
Length: 1.57 m
Area: 1.12 m²
Perimeter: 4.66 m

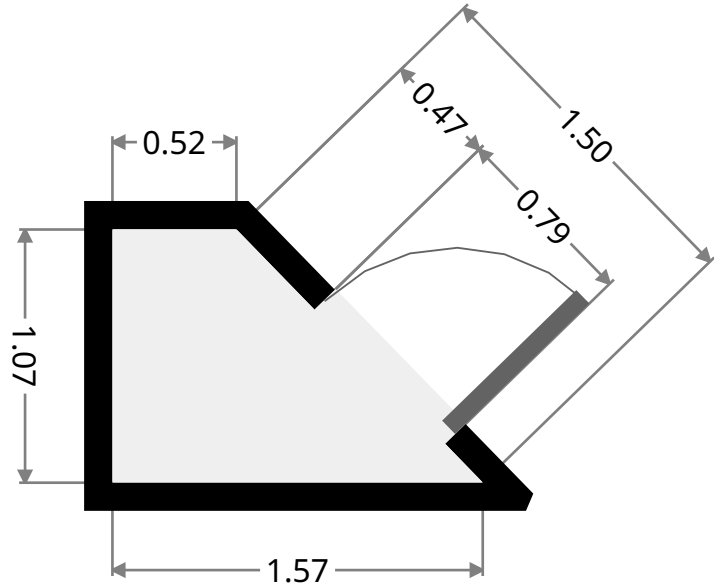
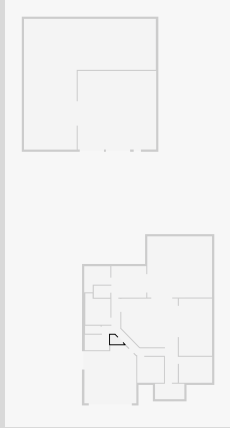

Bathroom

Width: 1.78 m
Length: 2.78 m
Area: 4.94 m²
Perimeter: 9.12 m

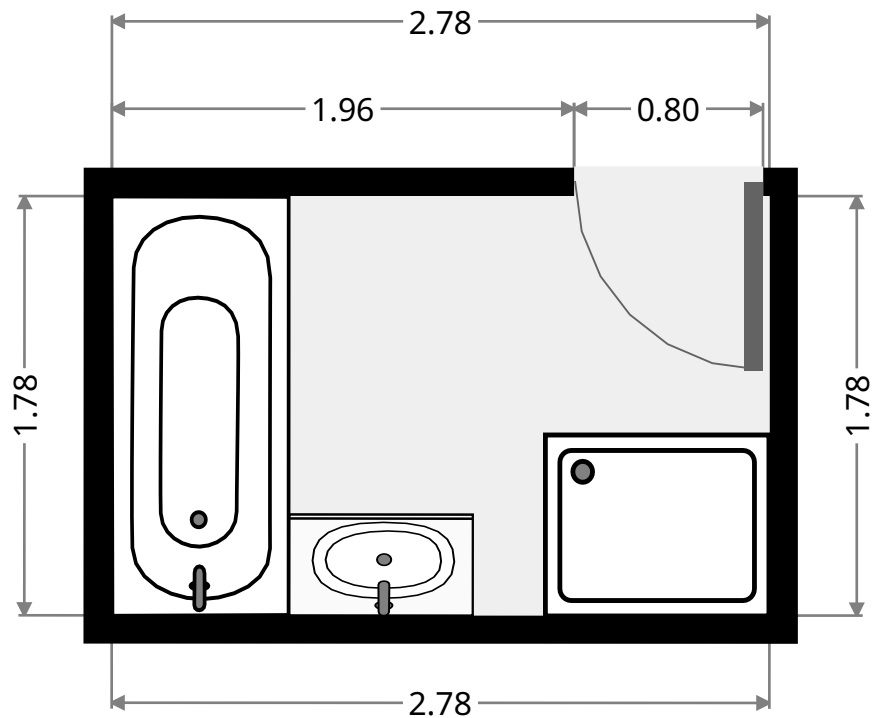
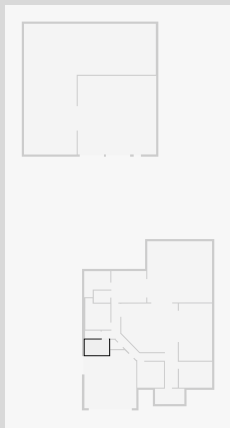

THIS FLOORPLAN IS PROVIDED WITHOUT WARRANTY OF ANY KIND. SENSOPIA DISCLAIMS ANY WARRANTY INCLUDING, WITHOUT LIMITATION, SATISFACTORY QUALITY OR ACCURACY OF DIMENSIONS.

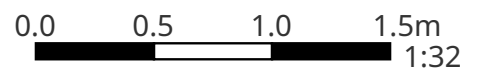

65 Perrott Drive

Garage

Width: 5.97 m
 Length: 6.65 m
 Area: 36.71 m²
 Perimeter: 24.44 m
 Ceiling Height: 2.17 m

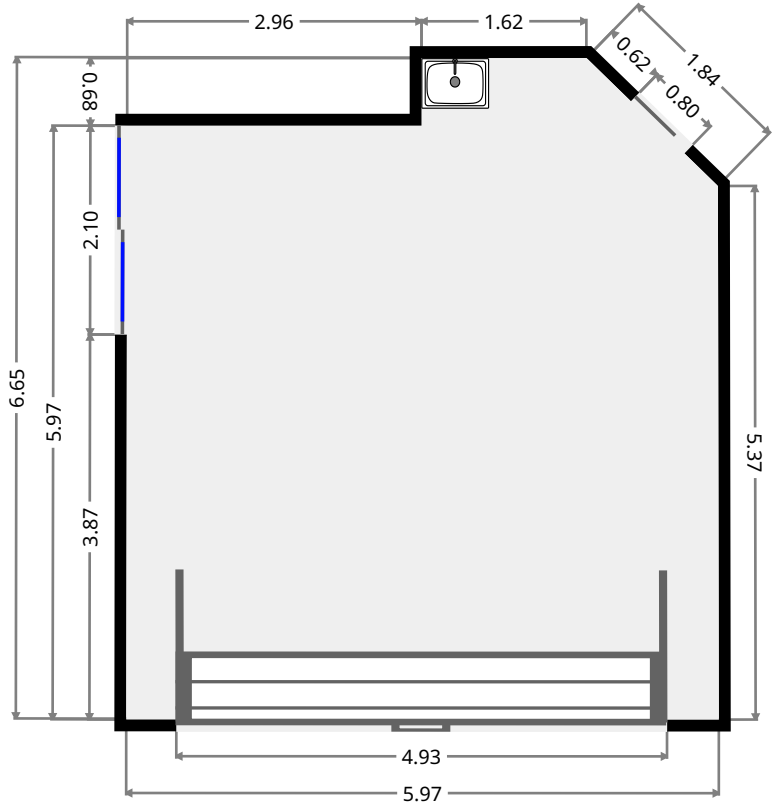
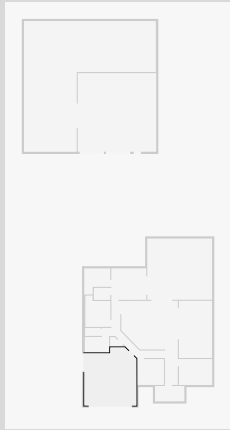

Toilet

Width: 0.91 m
 Length: 1.78 m
 Area: 1.62 m²
 Perimeter: 5.38 m

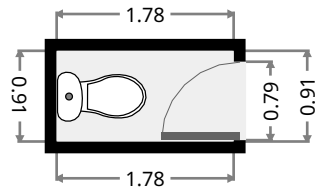
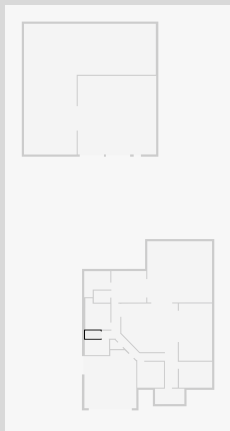

THIS FLOORPLAN IS PROVIDED WITHOUT WARRANTY OF ANY KIND. SENSOPIA DISCLAIMS ANY WARRANTY INCLUDING, WITHOUT LIMITATION, SATISFACTORY QUALITY OR ACCURACY OF DIMENSIONS.



65 Perrott Drive

Hall

Width: 2.13 m
 Length: 4.02 m
 Area: 4.93 m²
 Perimeter: 11.94 m
 Ceiling Height: 2.17 m

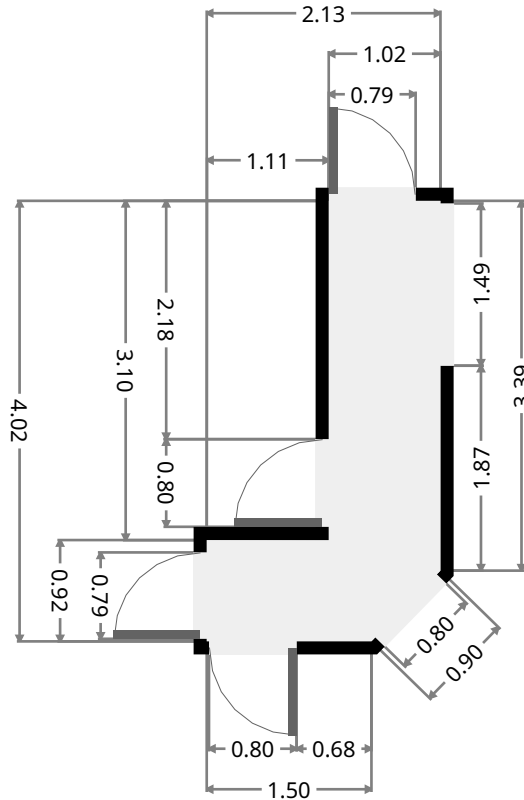
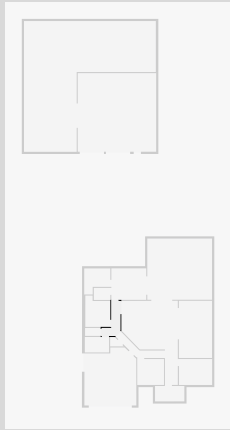

Hall

Width: 0.83 m
 Length: 3.35 m
 Area: 2.58 m²
 Perimeter: 8.03 m

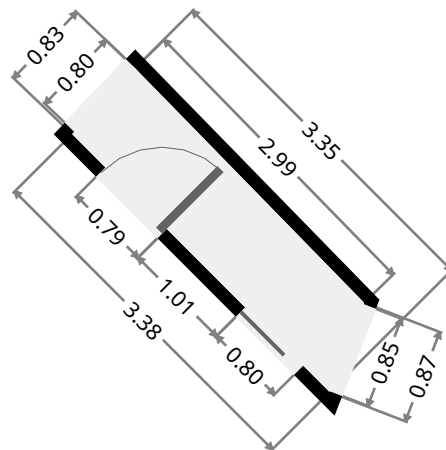
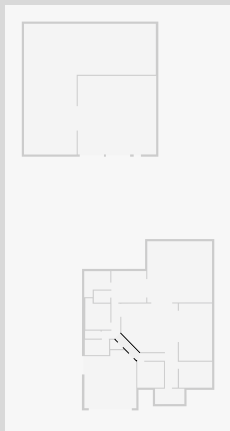

65 Perrott Drive

Bedroom

Width: 2.97 m
 Length: 3.06 m
 Area: 9.11 m²
 Perimeter: 12.07 m

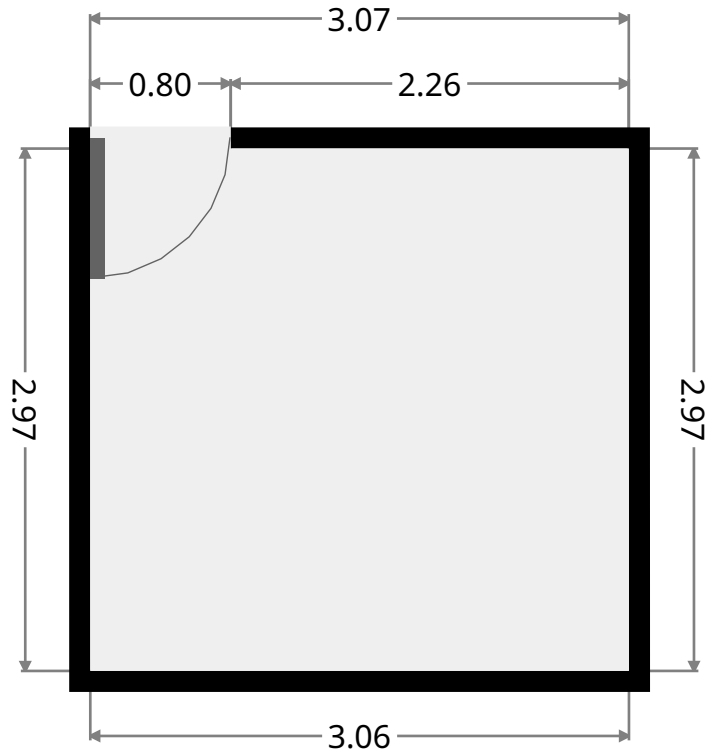
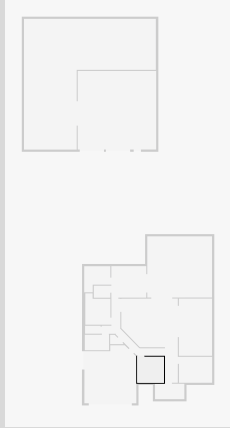

Bedroom

Width: 2.98 m
 Length: 3.81 m
 Area: 11.33 m²
 Perimeter: 13.57 m

