

# 65 Davis Street

**SUBMITTED BY**  
Ray White Rockhampton Casey  
stockers@cqoz.com

---

**CREATED ON**  
2022-10-18

---

**Floors**  
2

---

▼ Ground Floor

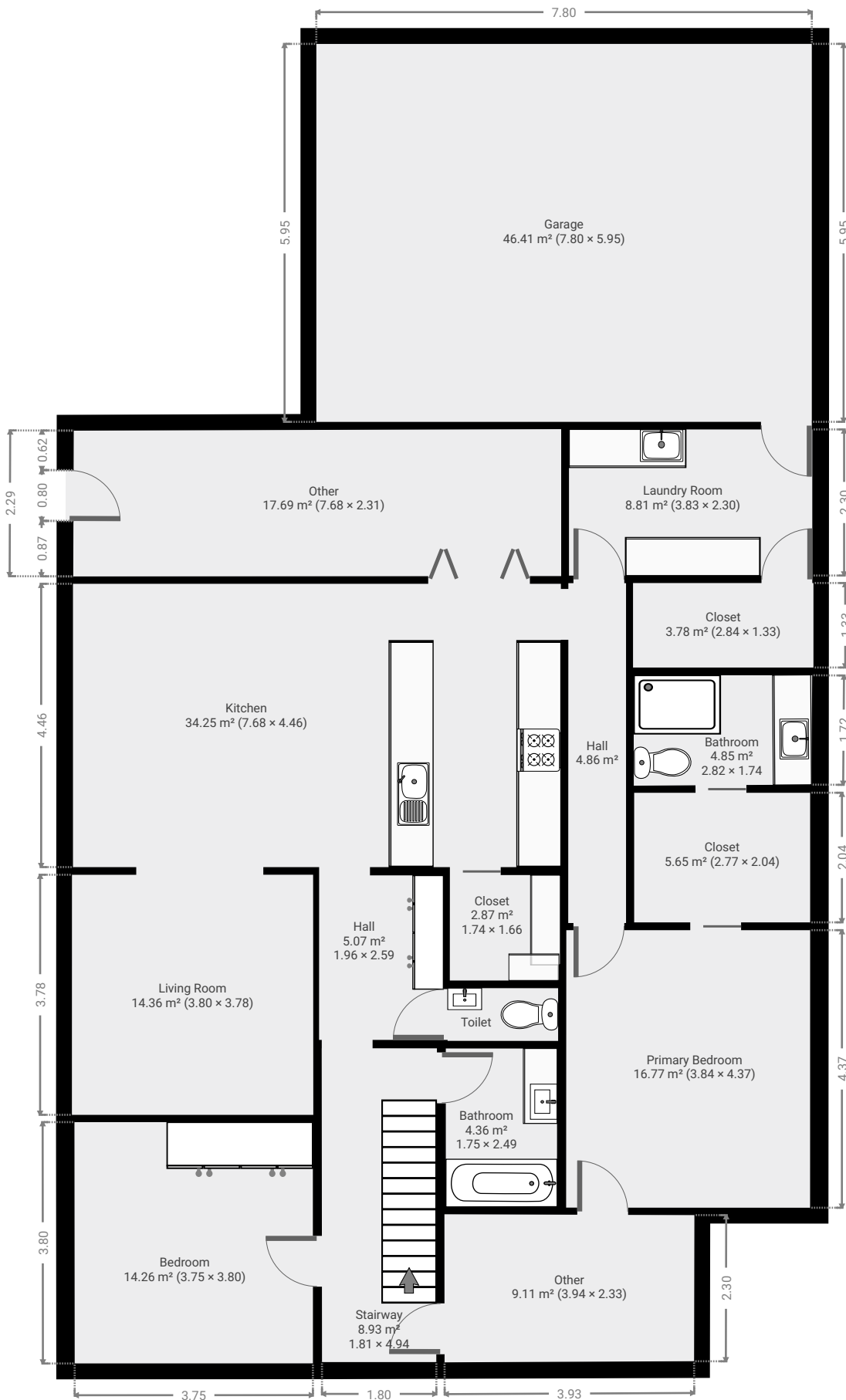

▼ **Bathroom**  
Ground Floor

WIDTH: 1.75 m • LENGTH: 2.49 m  
AREA: 4.36 m<sup>2</sup> • PERIMETER: 8.49 m

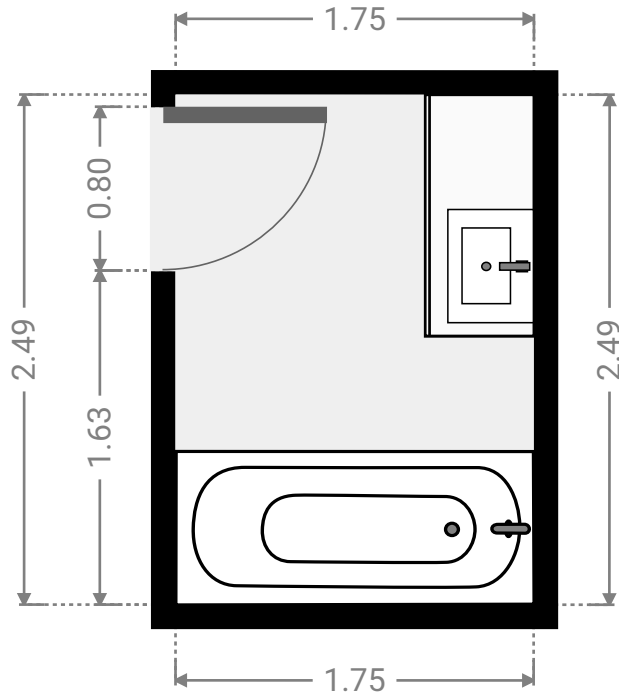

▼ **Bathroom**  
Ground Floor

WIDTH: 2.82 m • LENGTH: 1.74 m  
AREA: 4.85 m<sup>2</sup> • PERIMETER: 9.07 m

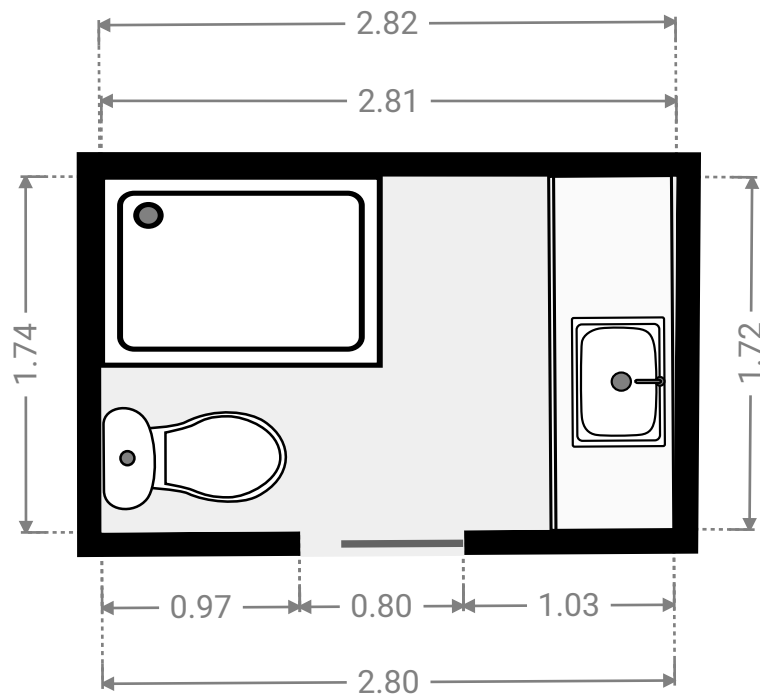
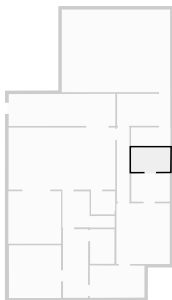

▼ **Bedroom**  
Ground Floor

WIDTH: 3.75 m • LENGTH: 3.80 m  
AREA: 14.26 m<sup>2</sup> • PERIMETER: 15.10 m

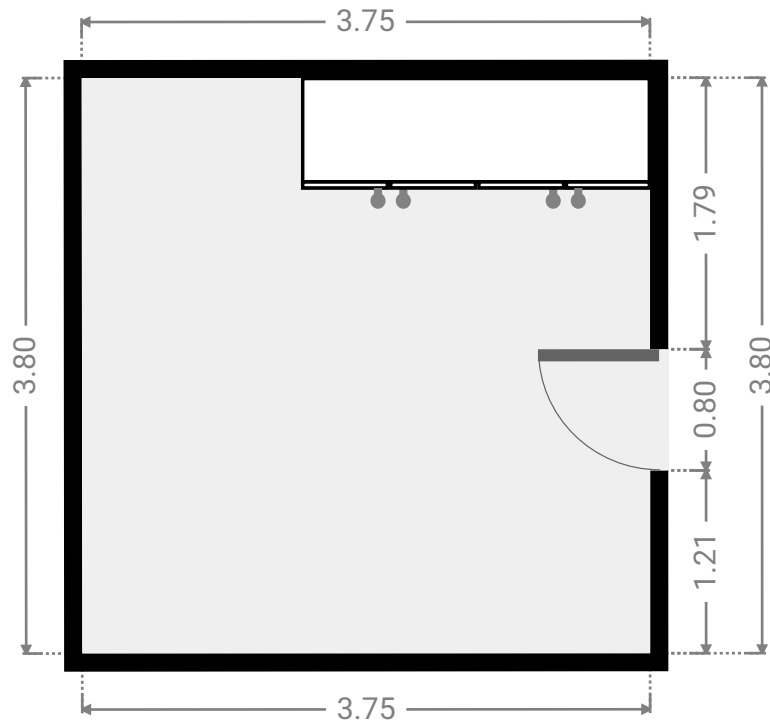
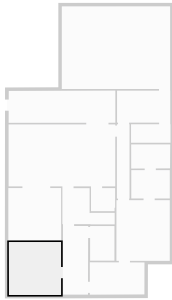

▼ **Closet**  
Ground Floor

WIDTH: 2.77 m • LENGTH: 2.04 m  
AREA: 5.65 m<sup>2</sup> • PERIMETER: 9.62 m

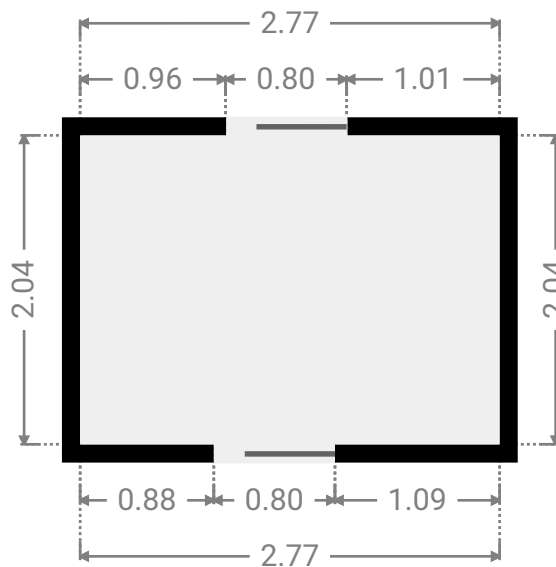
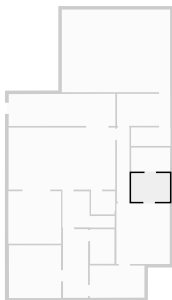

▼ **Garage**  
Ground Floor

WIDTH: 7.80 m • LENGTH: 5.95 m  
AREA: 46.41 m<sup>2</sup> • PERIMETER: 27.50 m

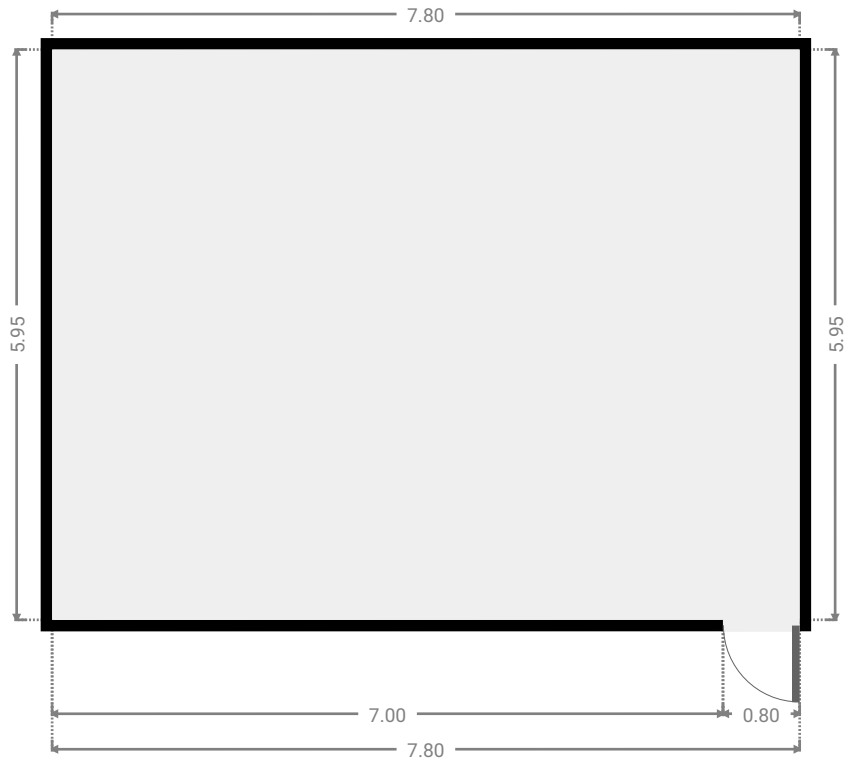
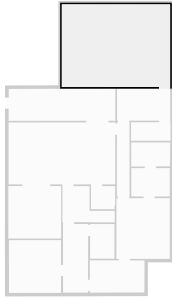

▼ **Hall**  
Ground Floor

WIDTH: 1.96 m • LENGTH: 2.59 m  
AREA: 5.07 m<sup>2</sup> • PERIMETER: 9.10 m

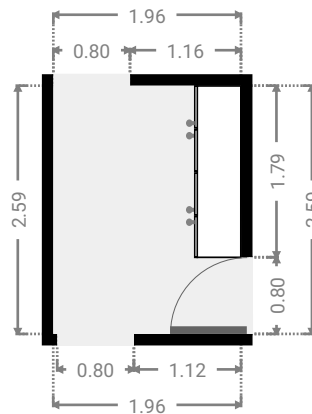
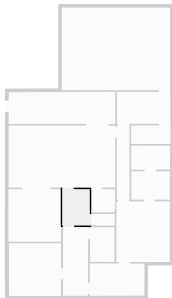

▼ **Hall**  
Ground Floor

WIDTH: 0.91 m • LENGTH: 5.35 m  
AREA: 4.86 m<sup>2</sup> • PERIMETER: 12.52 m

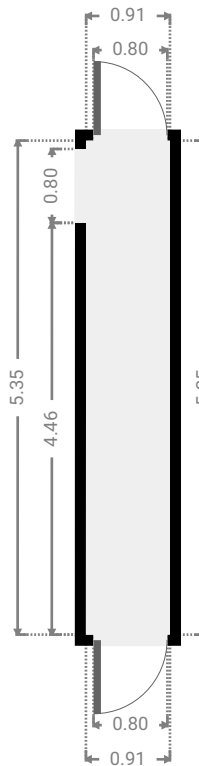

▼ **Kitchen**  
Ground Floor

WIDTH: 7.68 m • LENGTH: 4.46 m  
AREA: 34.25 m<sup>2</sup> • PERIMETER: 24.28 m

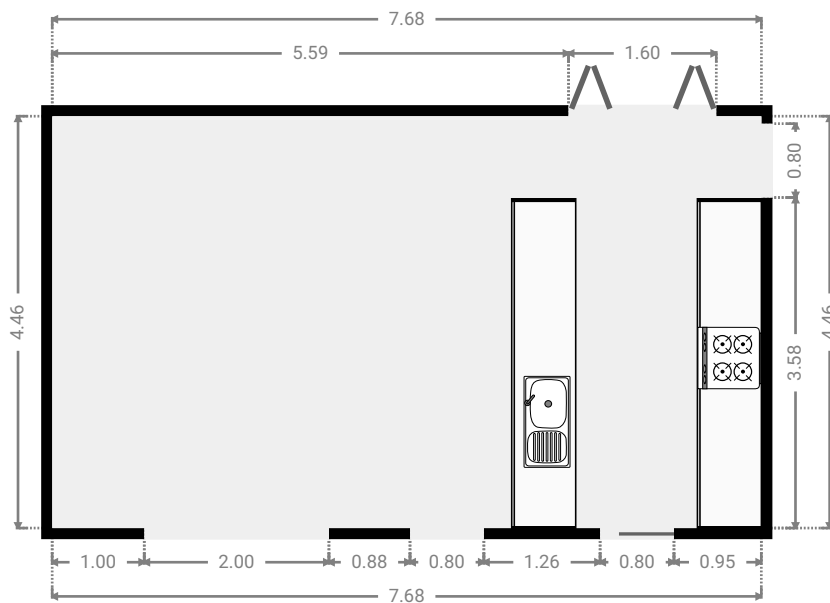
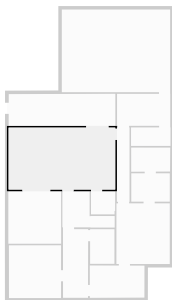

▼ **Closet**  
Ground Floor

WIDTH: 1.74 m • LENGTH: 1.66 m  
AREA: 2.87 m<sup>2</sup> • PERIMETER: 6.79 m

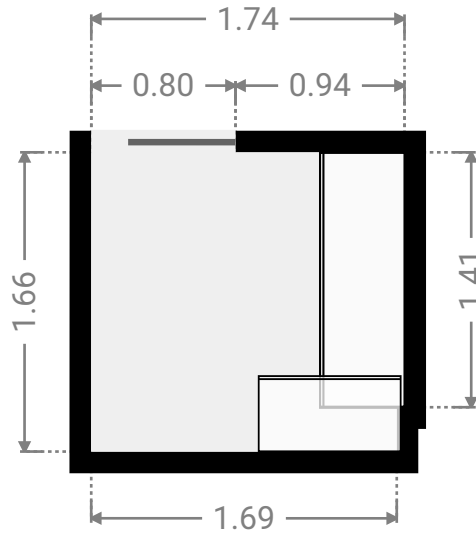
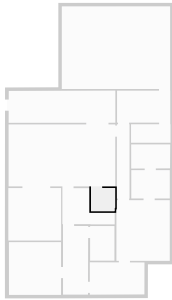

▼ **Laundry Room**  
Ground Floor

WIDTH: 3.83 m • LENGTH: 2.30 m  
AREA: 8.81 m<sup>2</sup> • PERIMETER: 12.26 m

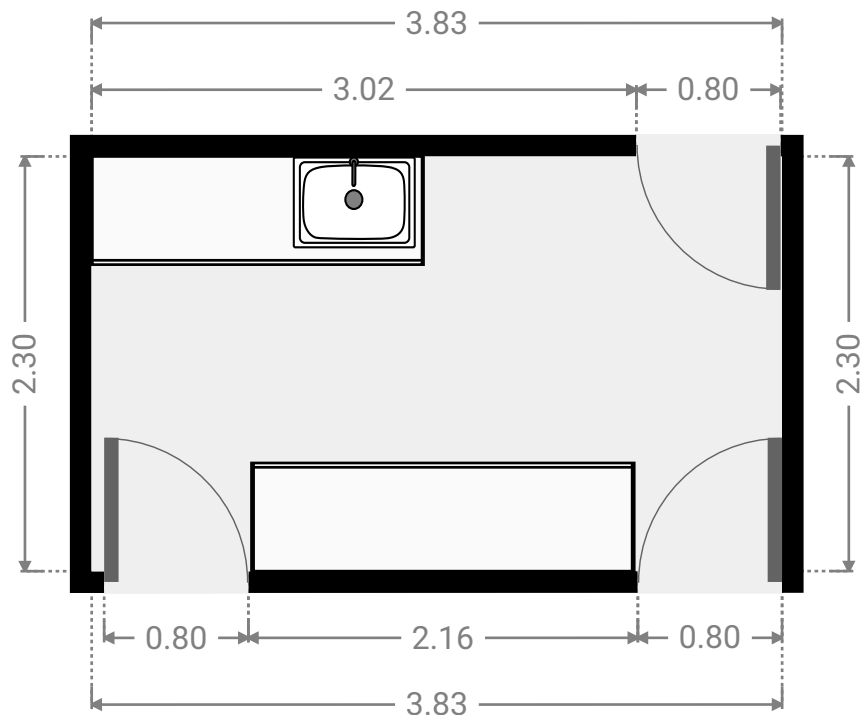
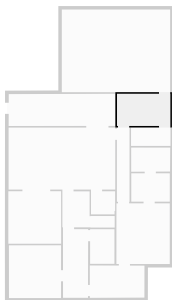

▼ **Closet**  
Ground Floor

WIDTH: 2.84 m • LENGTH: 1.33 m  
AREA: 3.78 m<sup>2</sup> • PERIMETER: 8.34 m

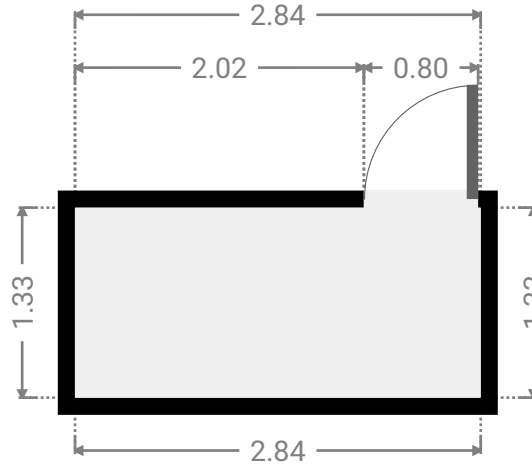
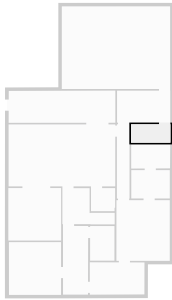

▼ **Living Room**  
Ground Floor

WIDTH: 3.80 m • LENGTH: 3.78 m  
AREA: 14.36 m<sup>2</sup> • PERIMETER: 15.16 m

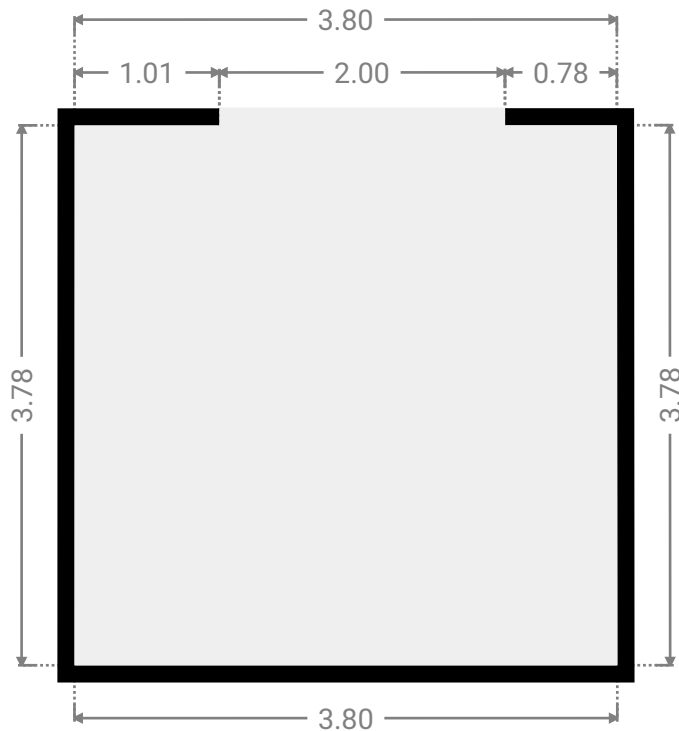
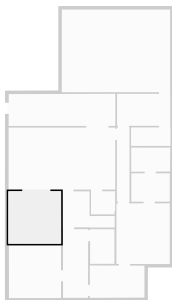



▼ Other  
Ground Floor

WIDTH: 7.68 m • LENGTH: 2.31 m  
AREA: 17.69 m<sup>2</sup> • PERIMETER: 19.96 m

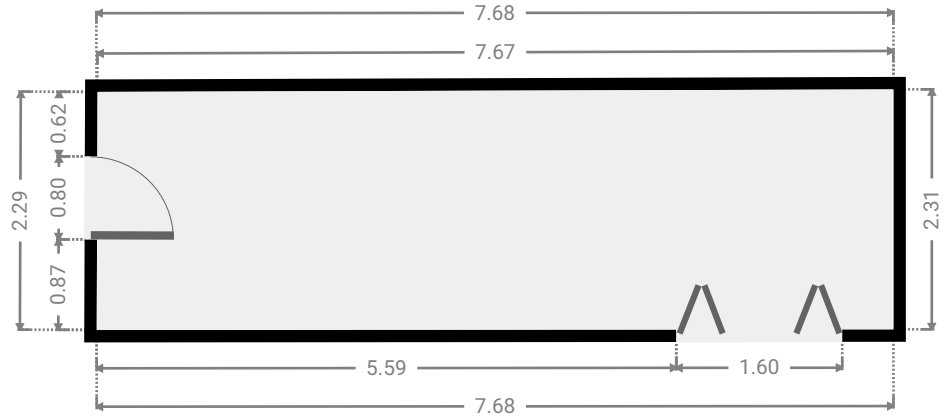
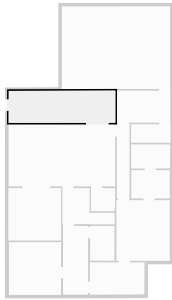

▼ Other  
Ground Floor

WIDTH: 3.94 m • LENGTH: 2.33 m  
AREA: 9.11 m<sup>2</sup> • PERIMETER: 12.50 m

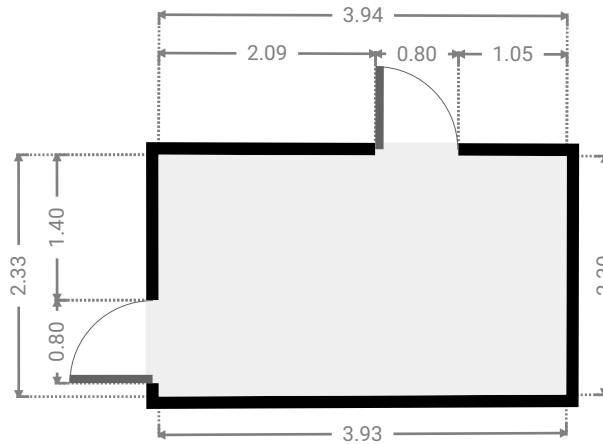
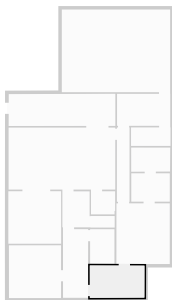

▼ Primary Bedroom  
Ground Floor

WIDTH: 3.84 m • LENGTH: 4.37 m  
AREA: 16.77 m<sup>2</sup> • PERIMETER: 16.42 m

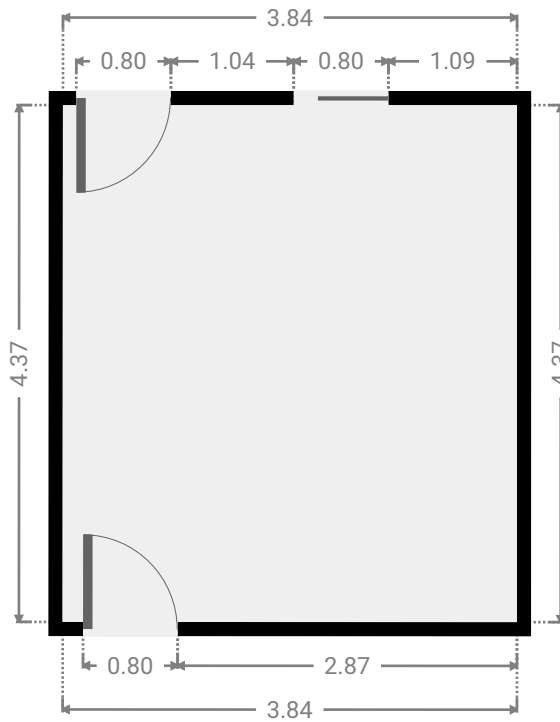
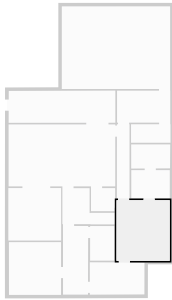

▼ Stairway  
Ground Floor

WIDTH: 1.81 m • LENGTH: 4.94 m  
AREA: 8.93 m<sup>2</sup> • PERIMETER: 13.50 m

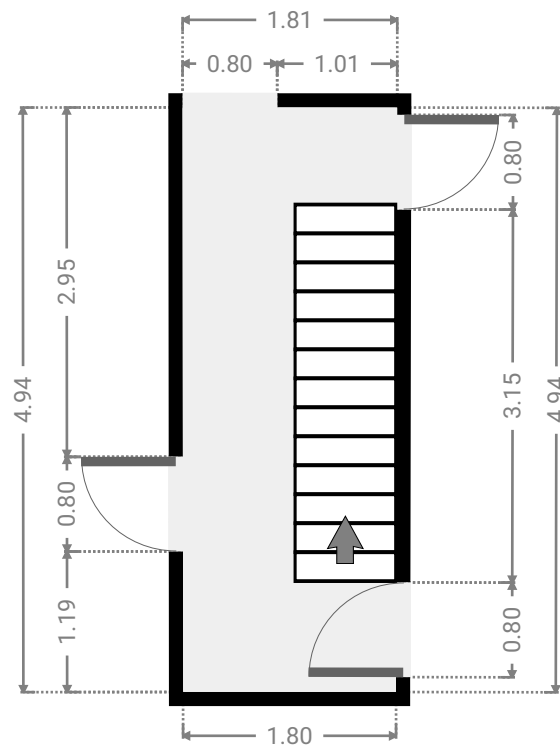
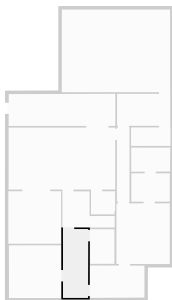

▼ Toilet  
Ground Floor

WIDTH: 1.74 m • LENGTH: 0.83 m  
AREA: 1.44 m<sup>2</sup> • PERIMETER: 5.14 m

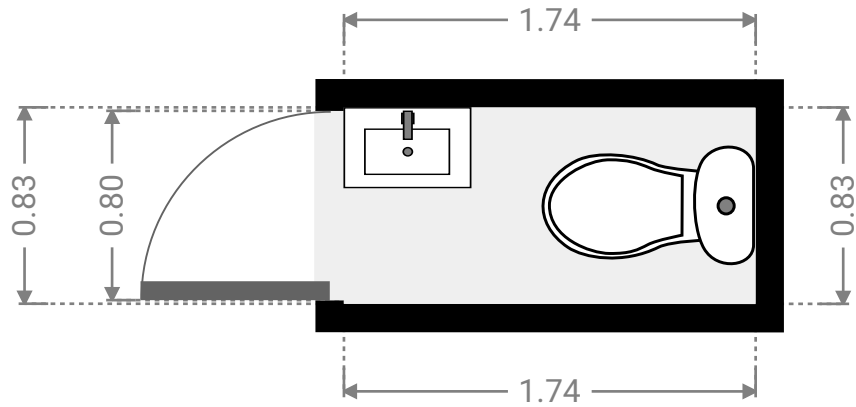

▼ 1st Floor

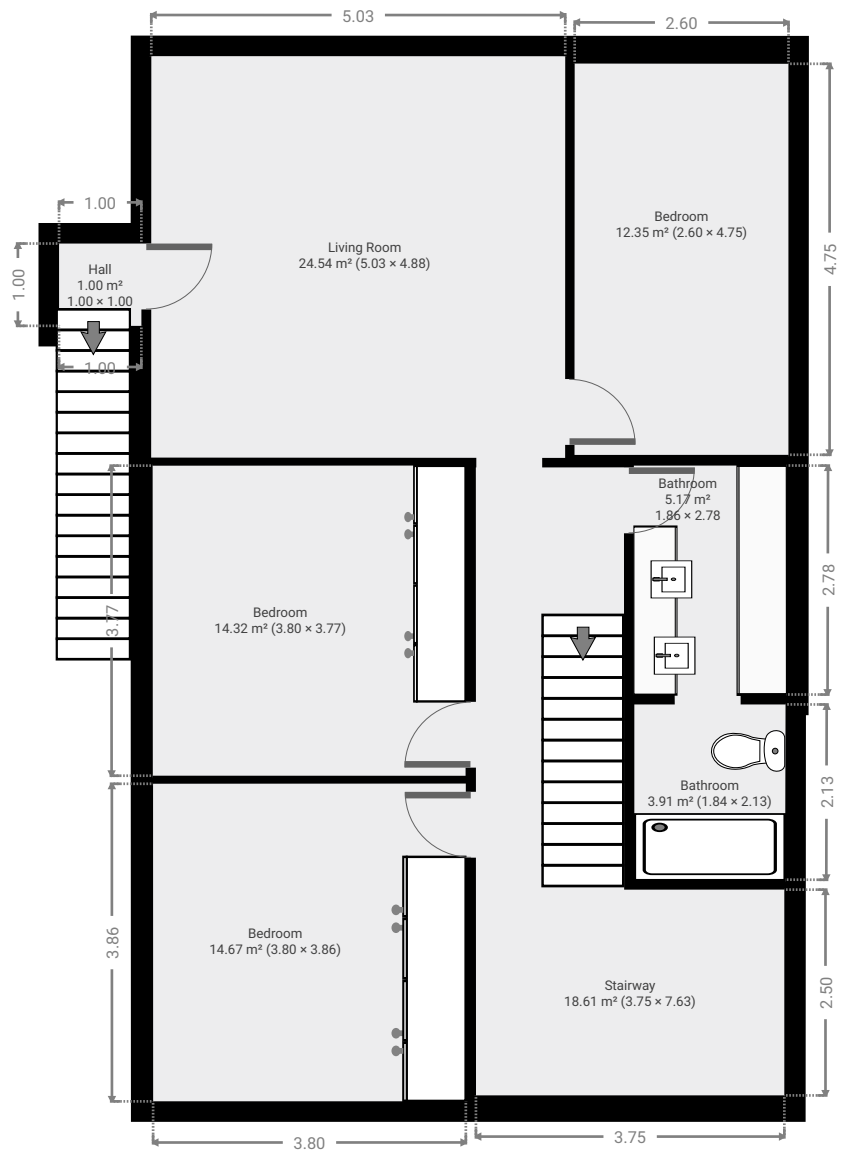

▼ Bathroom  
1st Floor

WIDTH: 1.84 m • LENGTH: 2.13 m  
AREA: 3.91 m<sup>2</sup> • PERIMETER: 7.93 m

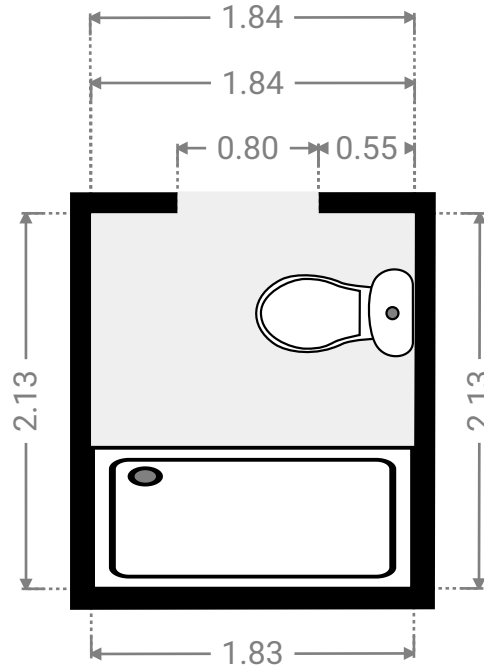
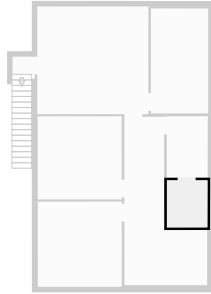

▼ Bathroom  
1st Floor

WIDTH: 1.86 m • LENGTH: 2.78 m  
AREA: 5.17 m<sup>2</sup> • PERIMETER: 9.28 m

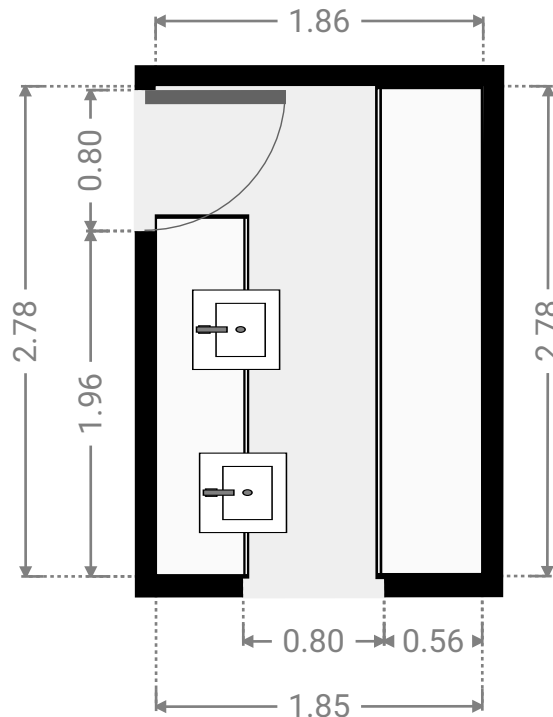
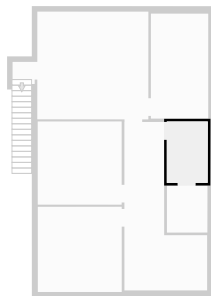

▼ Bedroom  
1st Floor

WIDTH: 3.80 m • LENGTH: 3.86 m  
AREA: 14.67 m<sup>2</sup> • PERIMETER: 15.32 m

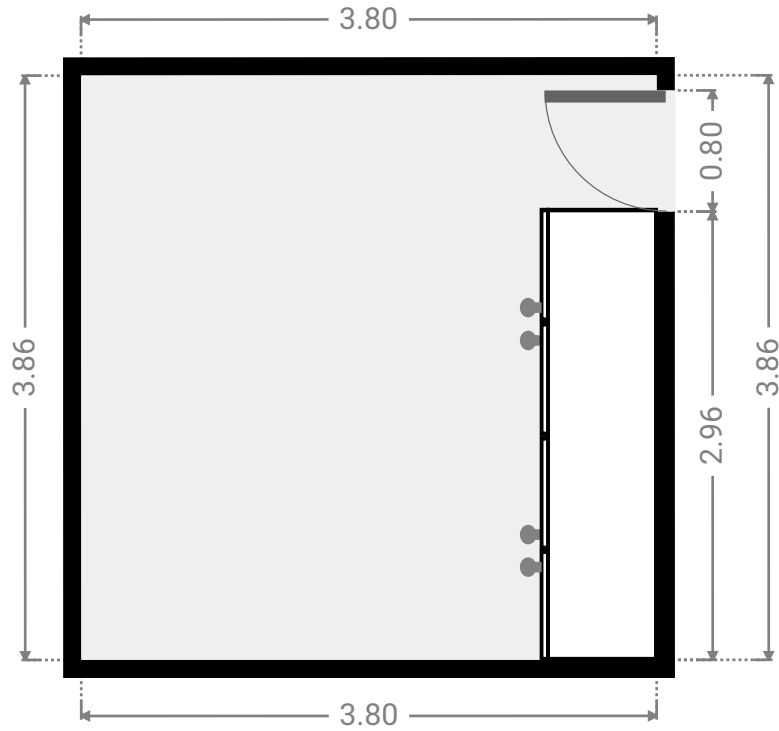
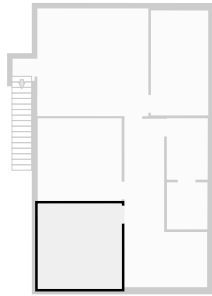

▼ Bedroom  
1st Floor

WIDTH: 3.80 m • LENGTH: 3.77 m  
AREA: 14.32 m<sup>2</sup> • PERIMETER: 15.14 m

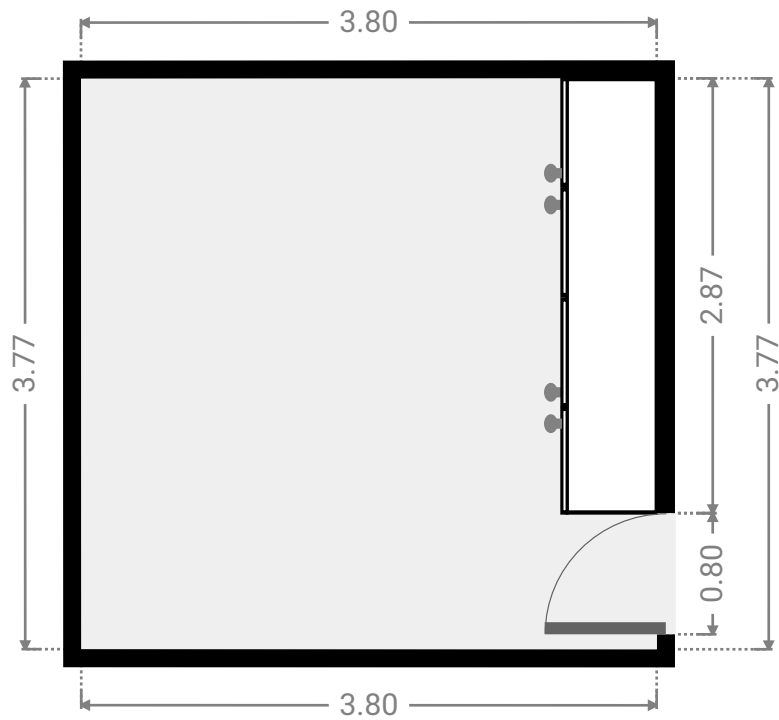
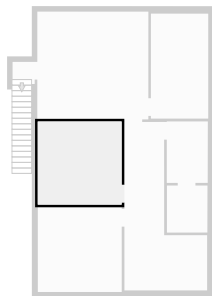

▼ **Bedroom**  
1st Floor

WIDTH: 2.60 m • LENGTH: 4.75 m  
AREA: 12.35 m<sup>2</sup> • PERIMETER: 14.70 m

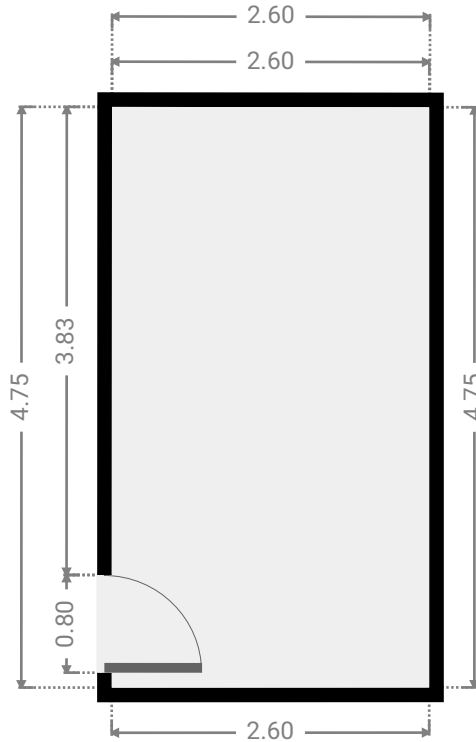
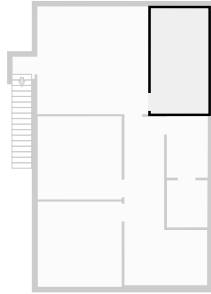

▼ **Hall**  
1st Floor

WIDTH: 1.00 m • LENGTH: 1.00 m  
AREA: 1.00 m<sup>2</sup> • PERIMETER: 4.00 m

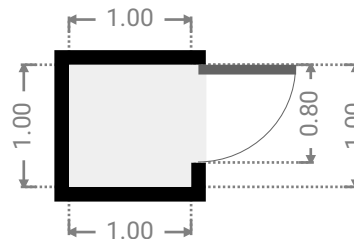
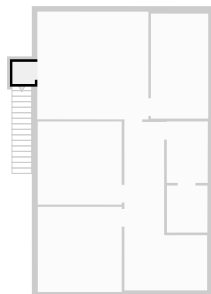

▼ Living Room  
1st Floor

WIDTH: 5.03 m • LENGTH: 4.88 m  
AREA: 24.54 m<sup>2</sup> • PERIMETER: 19.82 m

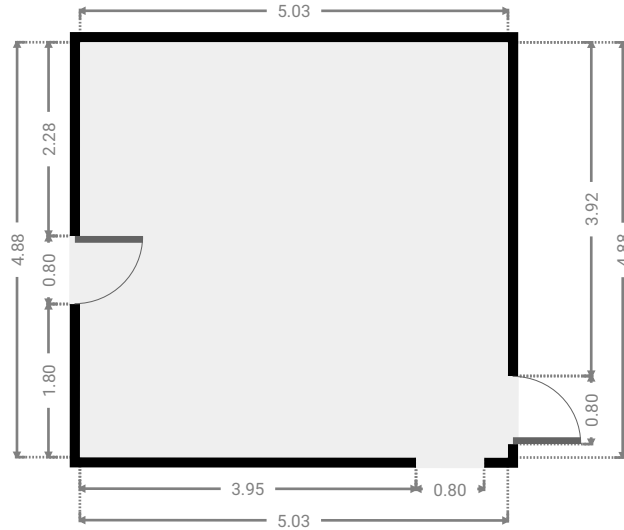
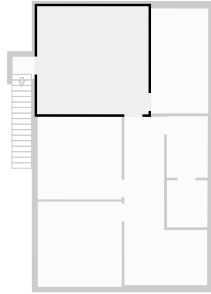

▼ Stairway  
1st Floor

WIDTH: 3.75 m • LENGTH: 7.63 m  
AREA: 18.61 m<sup>2</sup> • PERIMETER: 22.76 m

