

# 64 Hamilton Avenue

Created on  
2021-06-08

Floors  
1

▼ Ground Floor



▼ Living Room  
Ground Floor

WIDTH: 3.67 m • LENGTH: 4.35 m  
AREA: 15.97 m<sup>2</sup> • PERIMETER: 16.04 m

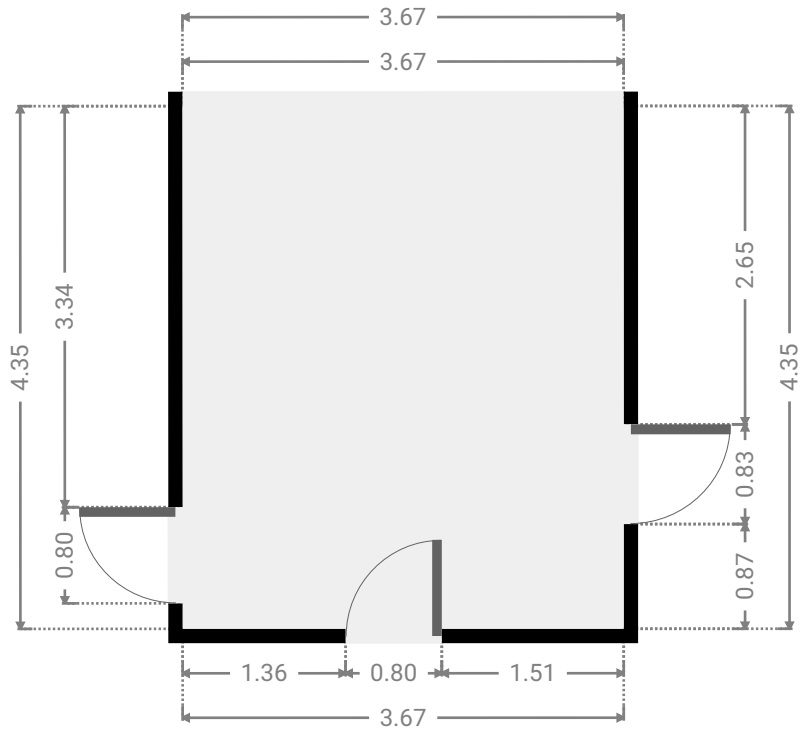
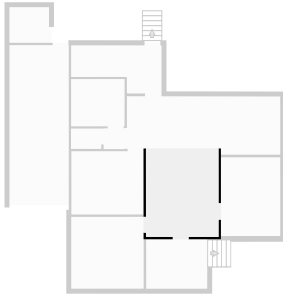

▼ Bedroom  
Ground Floor

WIDTH: 3.00 m • LENGTH: 3.98 m  
AREA: 11.94 m<sup>2</sup> • PERIMETER: 13.96 m

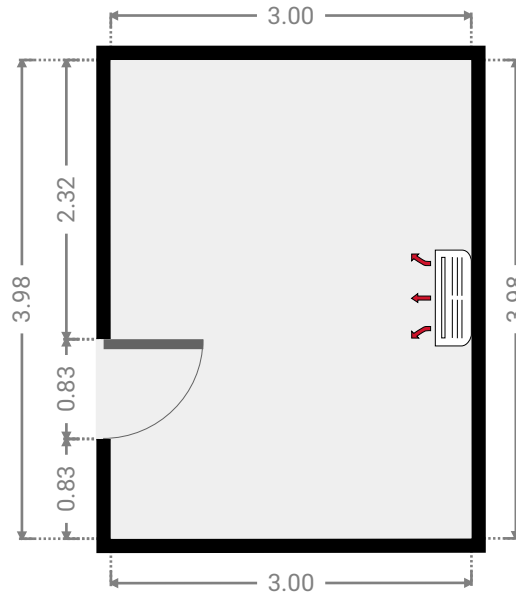
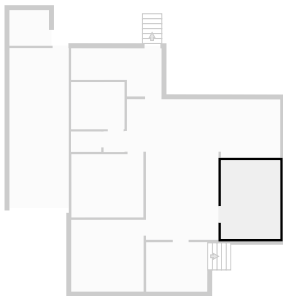

▼ **Master Bedroom**  
Ground Floor

WIDTH: 3.66 m • LENGTH: 3.63 m  
AREA: 13.28 m<sup>2</sup> • PERIMETER: 14.58 m

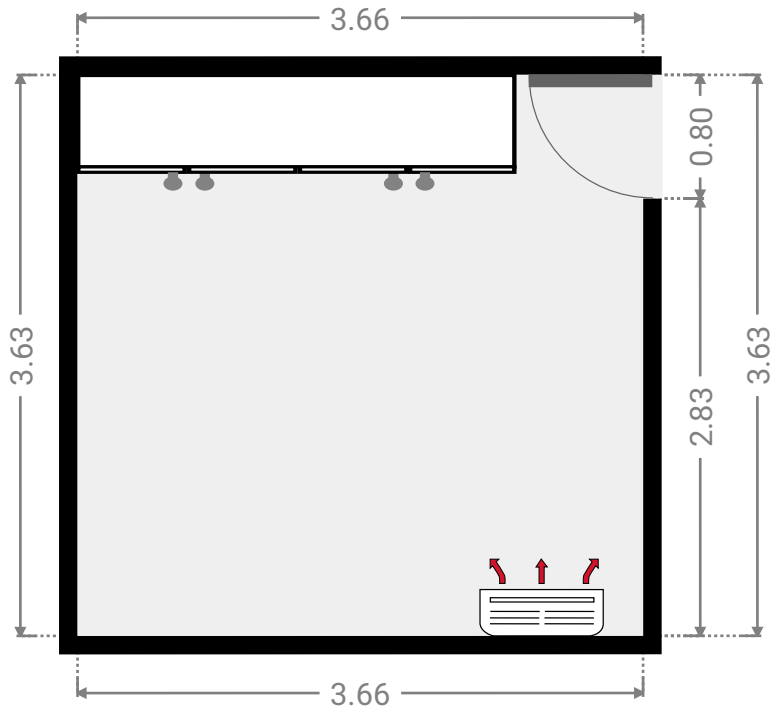
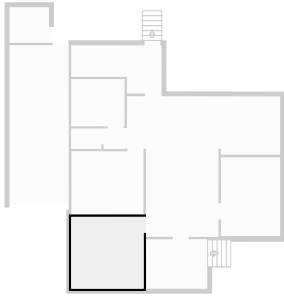

▼ **Bedroom**  
Ground Floor

WIDTH: 3.64 m • LENGTH: 3.20 m  
AREA: 11.65 m<sup>2</sup> • PERIMETER: 13.68 m

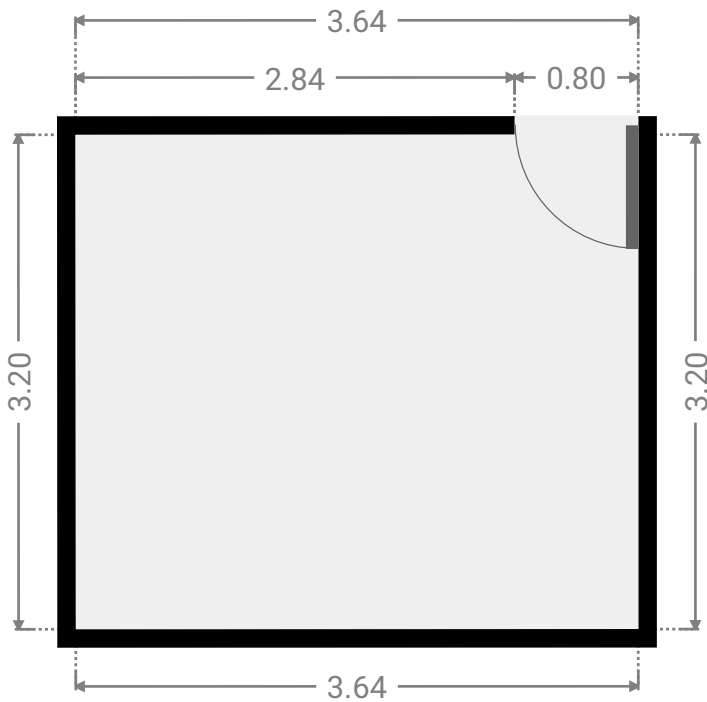
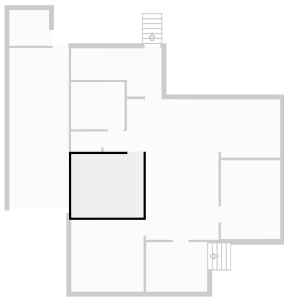

▼ Kitchen  
Ground Floor

WIDTH: 7.76 m • LENGTH: 2.95 m  
AREA: 21.43 m<sup>2</sup> • PERIMETER: 21.40 m

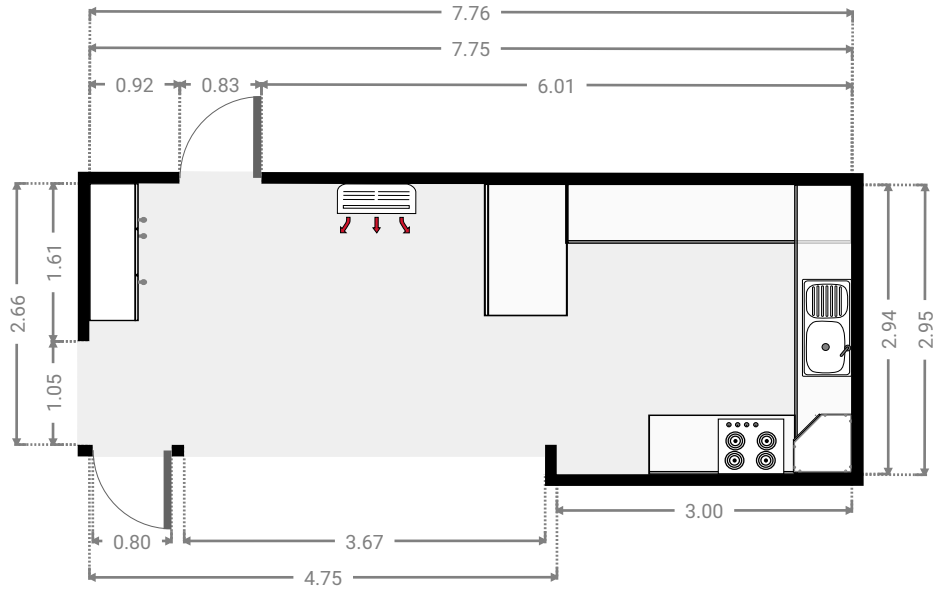
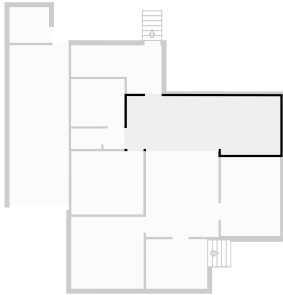

▼ Hall  
Ground Floor

WIDTH: 1.06 m • LENGTH: 1.05 m  
AREA: 1.11 m<sup>2</sup> • PERIMETER: 4.22 m

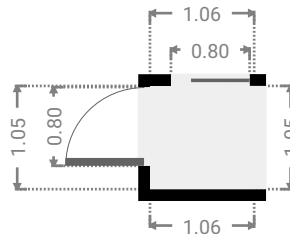
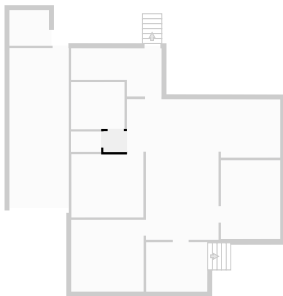

▼ **Bathroom**  
Ground Floor

WIDTH: 2.70 m • LENGTH: 2.39 m  
AREA: 6.46 m<sup>2</sup> • PERIMETER: 10.18 m

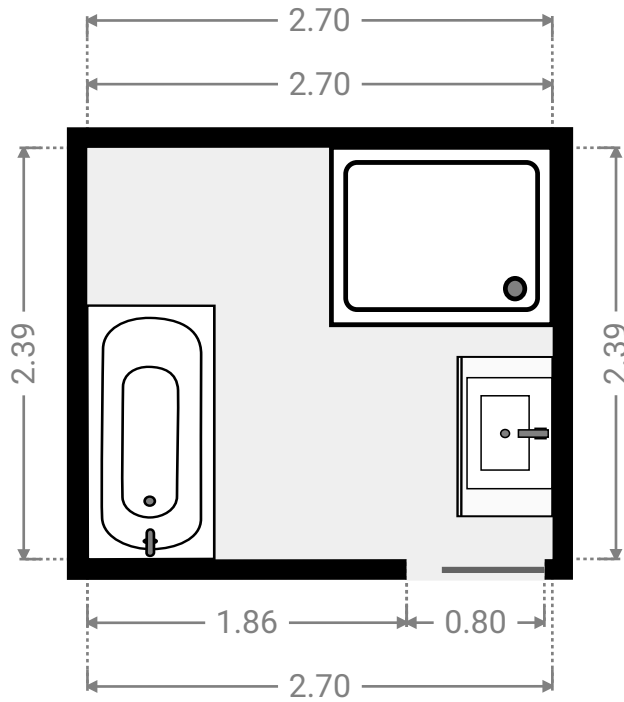
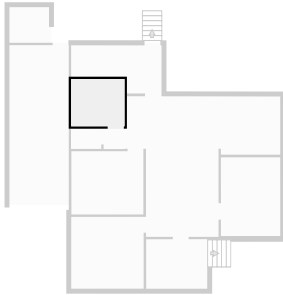

▼ **Toilet**  
Ground Floor

WIDTH: 1.53 m • LENGTH: 1.03 m  
AREA: 1.58 m<sup>2</sup> • PERIMETER: 5.12 m

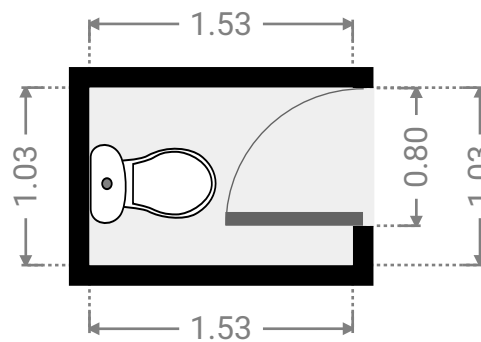
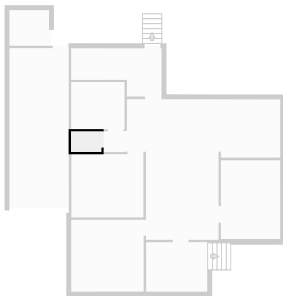

▼ Laundry Room  
Ground Floor

WIDTH: 4.57 m • LENGTH: 2.43 m  
AREA: 8.76 m<sup>2</sup> • PERIMETER: 14.01 m

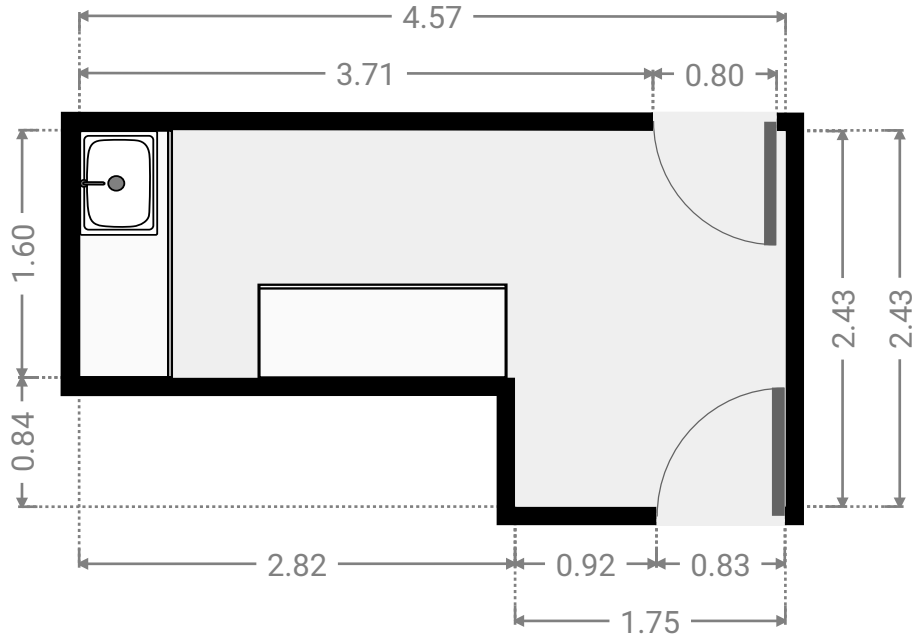
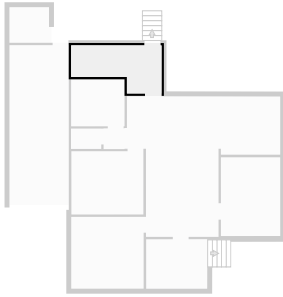

▼ Other  
Ground Floor

WIDTH: 3.09 m • LENGTH: 2.50 m  
AREA: 7.73 m<sup>2</sup> • PERIMETER: 11.18 m

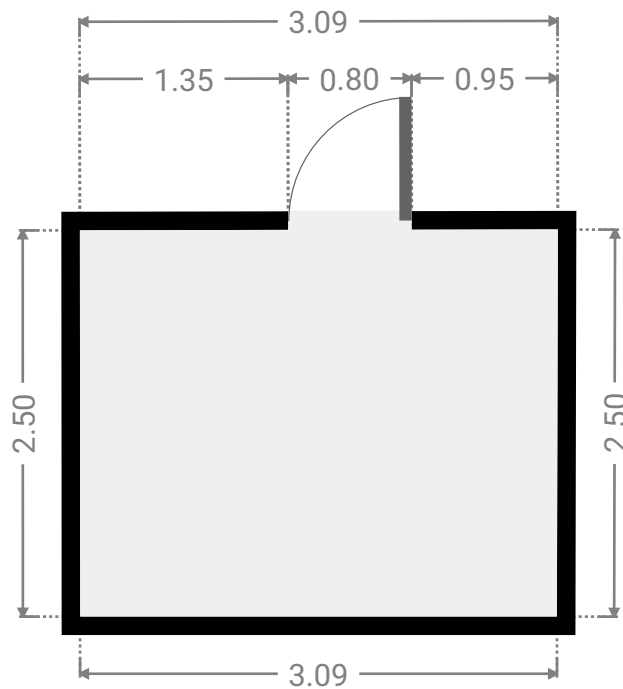
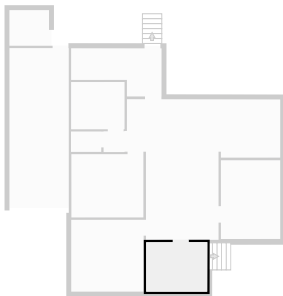

▼ **Garage**  
Ground Floor

WIDTH: 3.00 m • LENGTH: 7.96 m  
AREA: 23.87 m<sup>2</sup> • PERIMETER: 21.92 m

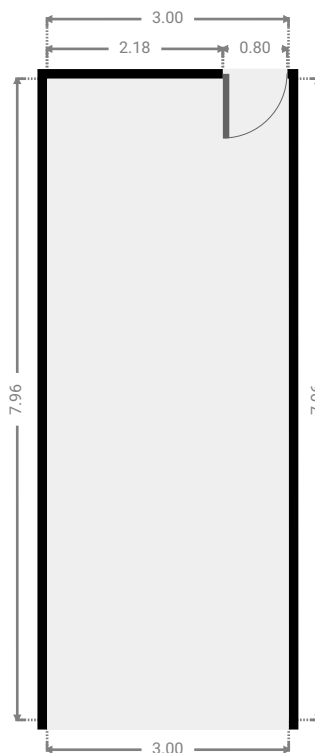
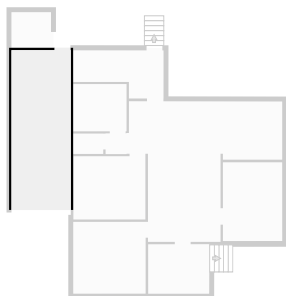

▼ **Other**  
Ground Floor

WIDTH: 2.00 m • LENGTH: 1.80 m  
AREA: 3.60 m<sup>2</sup> • PERIMETER: 7.60 m

