

# 62 Goodson Road

Created on  
2020-07-02

Floors

1

▼ Ground Floor

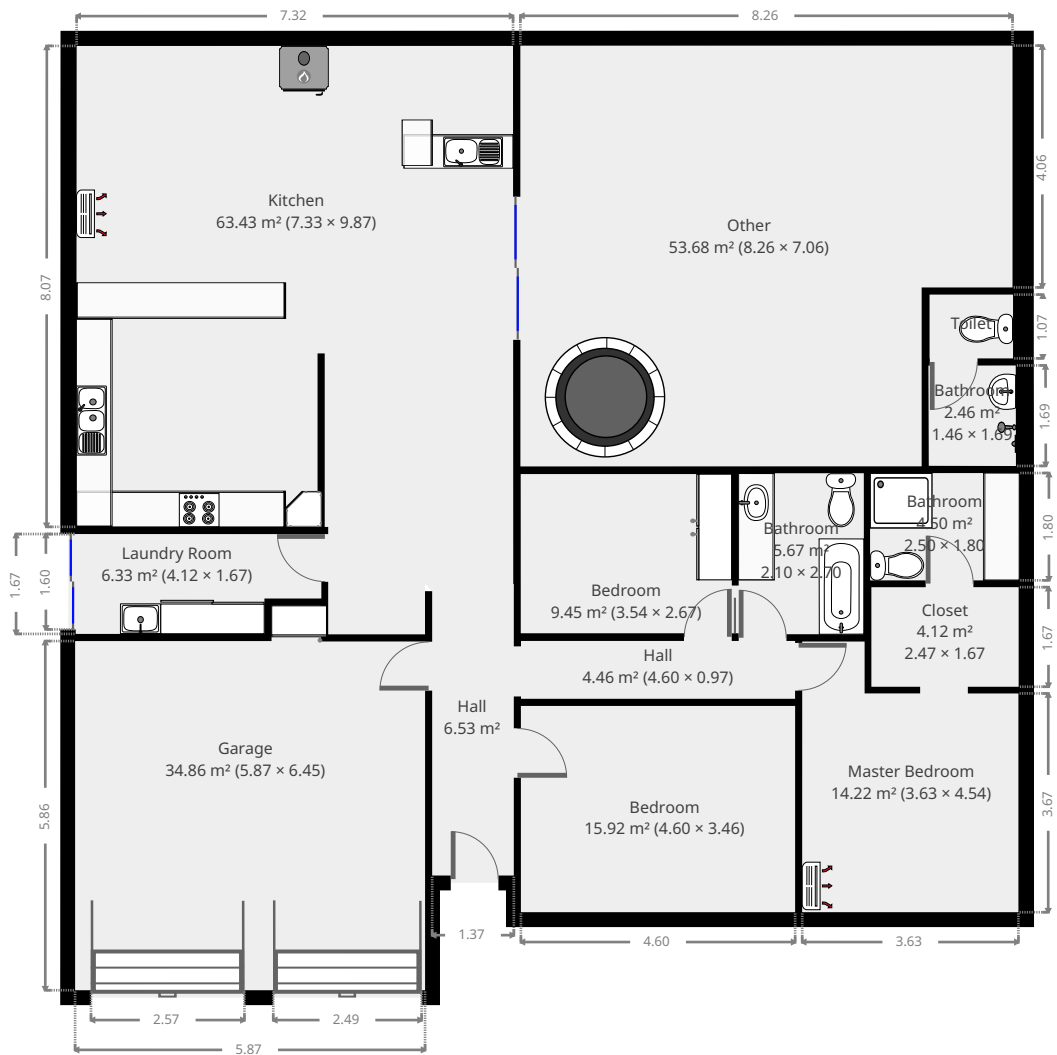
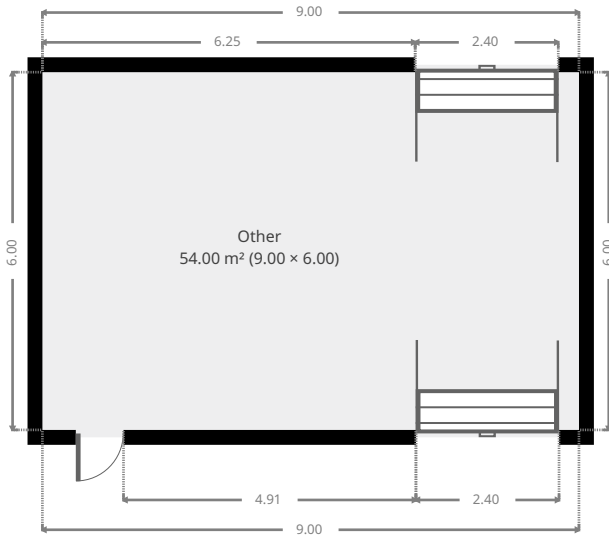

THIS FLOORPLAN IS PROVIDED WITHOUT WARRANTY OF ANY KIND. SENSOPIA DISCLAIMS ANY WARRANTY INCLUDING, WITHOUT LIMITATION, SATISFACTORY QUALITY OR ACCURACY OF DIMENSIONS.

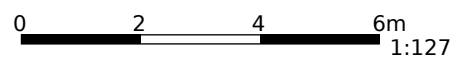

FLOORS: 1

▼ **Hall**  
Ground Floor

**WIDTH:** 1.37 m • **LENGTH:** 4.77 m  
**AREA:** 6.53 m<sup>2</sup> • **PERIMETER:** 12.28 m

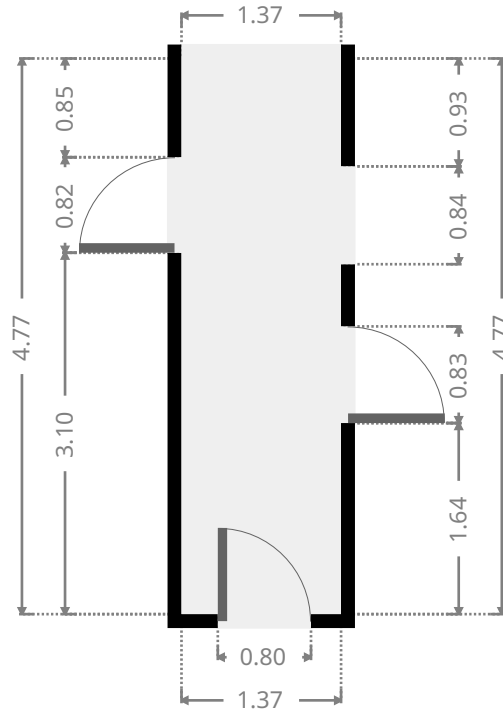
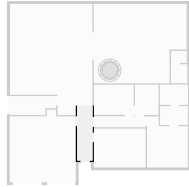

▼ **Bedroom**  
Ground Floor

**WIDTH:** 4.60 m • **LENGTH:** 3.46 m  
**AREA:** 15.92 m<sup>2</sup> • **PERIMETER:** 16.12 m

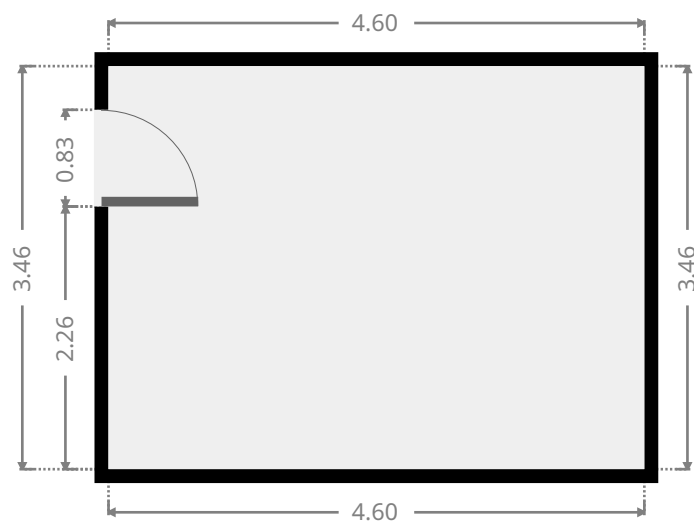
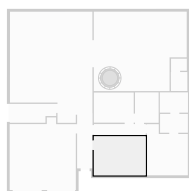

FLOORS: 1

▼ **Hall**  
Ground Floor

WIDTH: 4.60 m • LENGTH: 0.97 m  
AREA: 4.46 m<sup>2</sup> • PERIMETER: 11.13 m

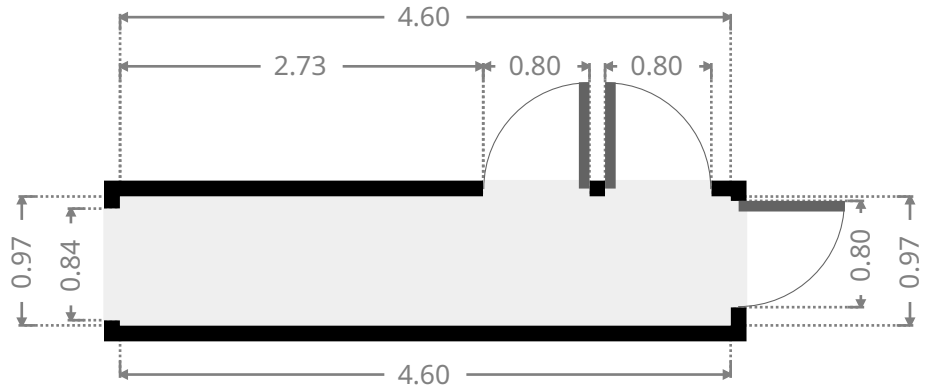
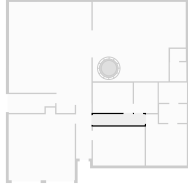

▼ **Bedroom**  
Ground Floor

WIDTH: 3.54 m • LENGTH: 2.67 m  
AREA: 9.45 m<sup>2</sup> • PERIMETER: 12.42 m

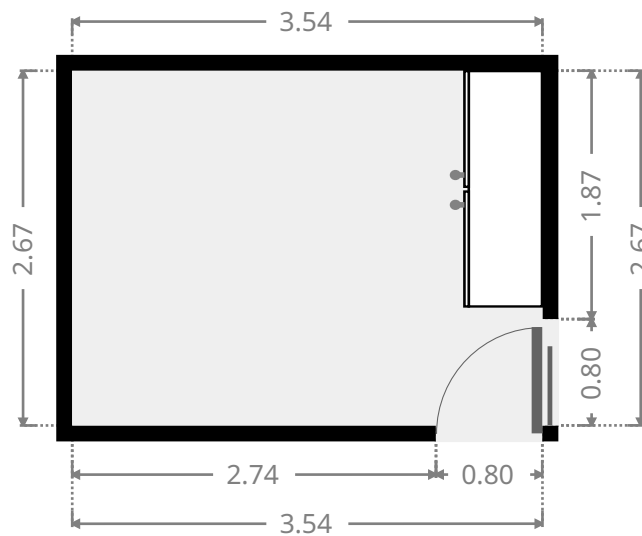
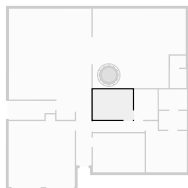

FLOORS: 1

▼ **Bathroom**  
Ground Floor

WIDTH: 2.10 m • LENGTH: 2.70 m  
AREA: 5.67 m<sup>2</sup> • PERIMETER: 9.60 m

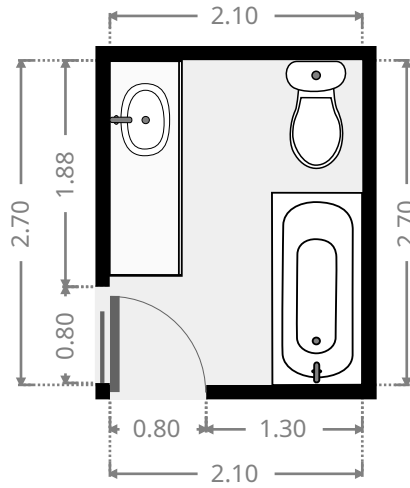
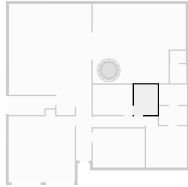

▼ **Master Bedroom**  
Ground Floor

WIDTH: 3.63 m • LENGTH: 4.54 m  
AREA: 14.22 m<sup>2</sup> • PERIMETER: 16.33 m

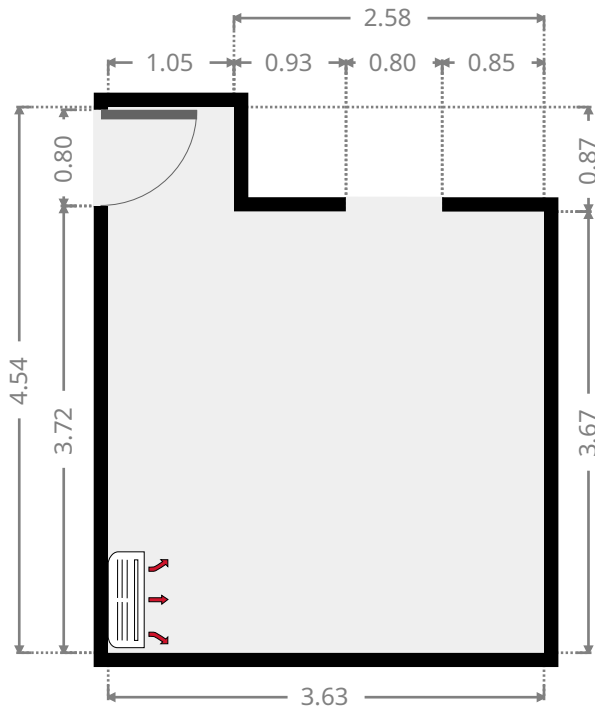
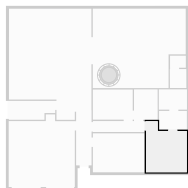

FLOORS: 1

▼ **Closet**  
Ground Floor

WIDTH: 2.47 m • LENGTH: 1.67 m  
AREA: 4.12 m<sup>2</sup> • PERIMETER: 8.28 m

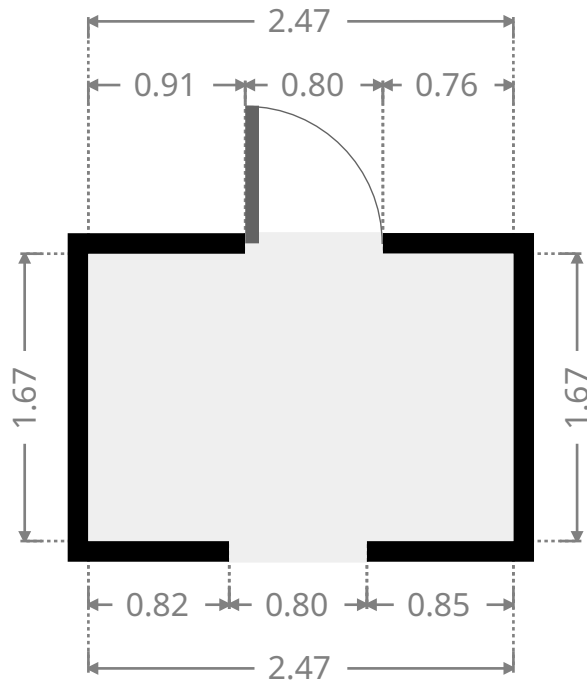
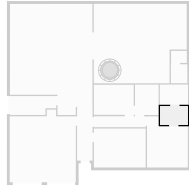

▼ **Bathroom**  
Ground Floor

WIDTH: 2.50 m • LENGTH: 1.80 m  
AREA: 4.50 m<sup>2</sup> • PERIMETER: 8.60 m

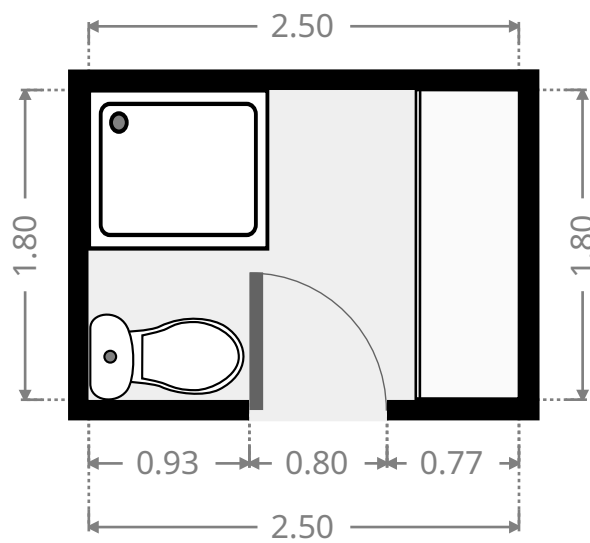
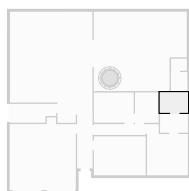

FLOORS: 1

▼ **Garage**  
Ground Floor

**WIDTH:** 5.87 m • **LENGTH:** 6.45 m  
**AREA:** 34.86 m<sup>2</sup> • **PERIMETER:** 24.64 m

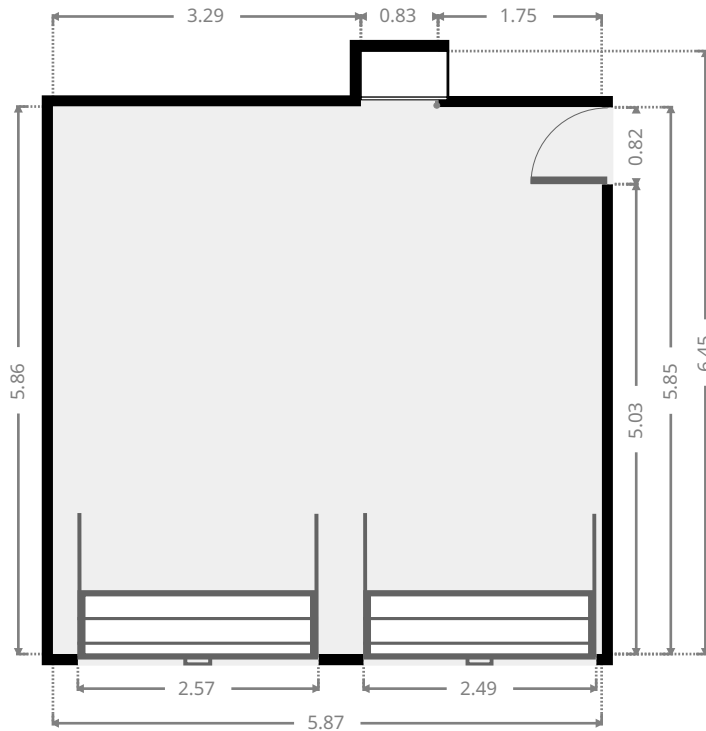
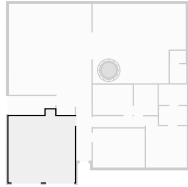

▼ **Laundry Room**  
Ground Floor

**WIDTH:** 4.12 m • **LENGTH:** 1.67 m  
**AREA:** 6.33 m<sup>2</sup> • **PERIMETER:** 11.59 m

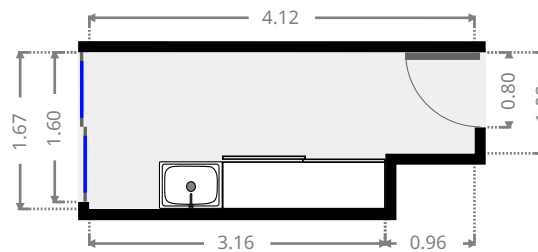
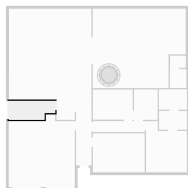

FLOORS: 1

▼ **Kitchen**  
Ground Floor

WIDTH: 7.33 m • LENGTH: 9.87 m  
AREA: 63.43 m<sup>2</sup> • PERIMETER: 34.38 m

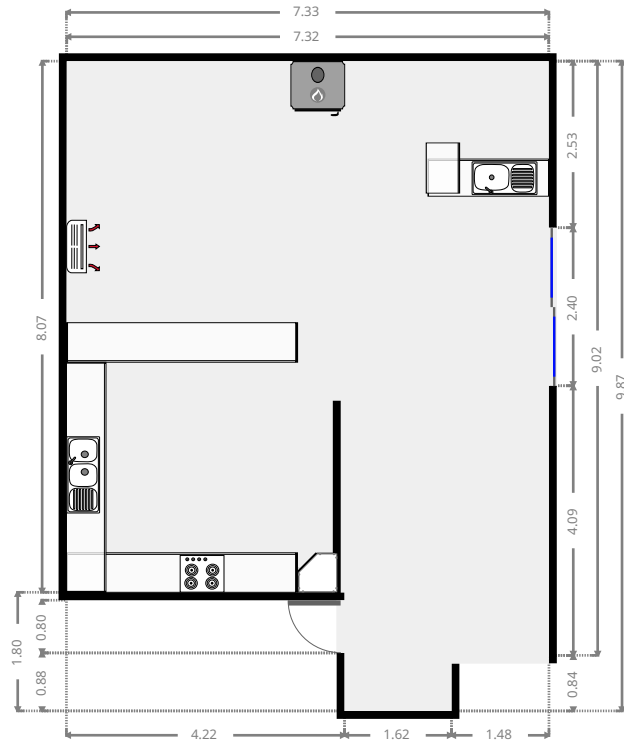
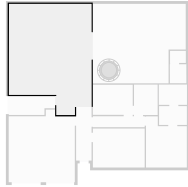

▼ **Other**  
Ground Floor

WIDTH: 8.26 m • LENGTH: 7.06 m  
AREA: 53.68 m<sup>2</sup> • PERIMETER: 30.62 m

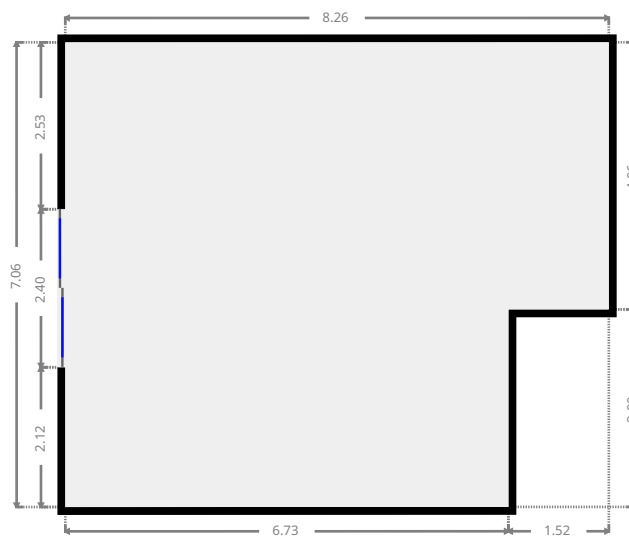
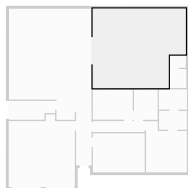

THIS FLOORPLAN IS PROVIDED WITHOUT WARRANTY OF ANY KIND. SENSOPIA DISCLAIMS ANY WARRANTY INCLUDING, WITHOUT LIMITATION, SATISFACTORY QUALITY OR ACCURACY OF DIMENSIONS.





FLOORS: 1

▼ **Toilet**  
Ground Floor

WIDTH: 1.40 m • LENGTH: 1.07 m  
AREA: 1.50 m<sup>2</sup> • PERIMETER: 4.94 m

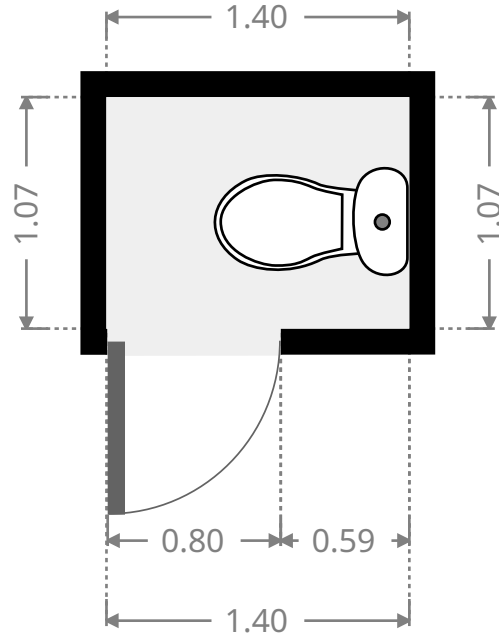
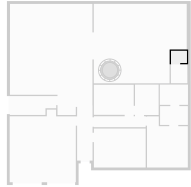

▼ **Bathroom**  
Ground Floor

WIDTH: 1.46 m • LENGTH: 1.69 m  
AREA: 2.46 m<sup>2</sup> • PERIMETER: 6.29 m

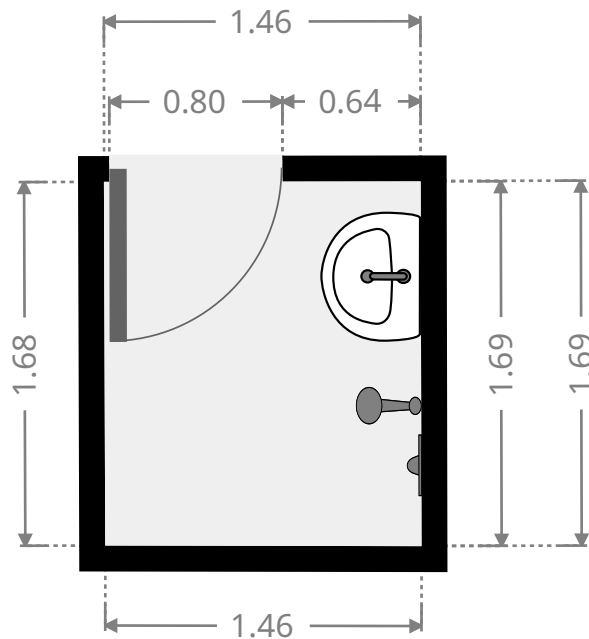
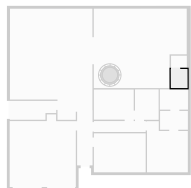

FLOORS: 1

## ▼ Other Ground Floor

WIDTH: 9.00 m • LENGTH: 6.00 m  
AREA: 54.00 m<sup>2</sup> • PERIMETER: 30.00 m

