

# 62 Agnes street

**SUBMITTED BY**

Ray White Rockhampton Casey  
stockers@cqoz.com

---

**CREATED ON**

2022-12-12

---

**Floors**

2

---

▼ Ground Floor

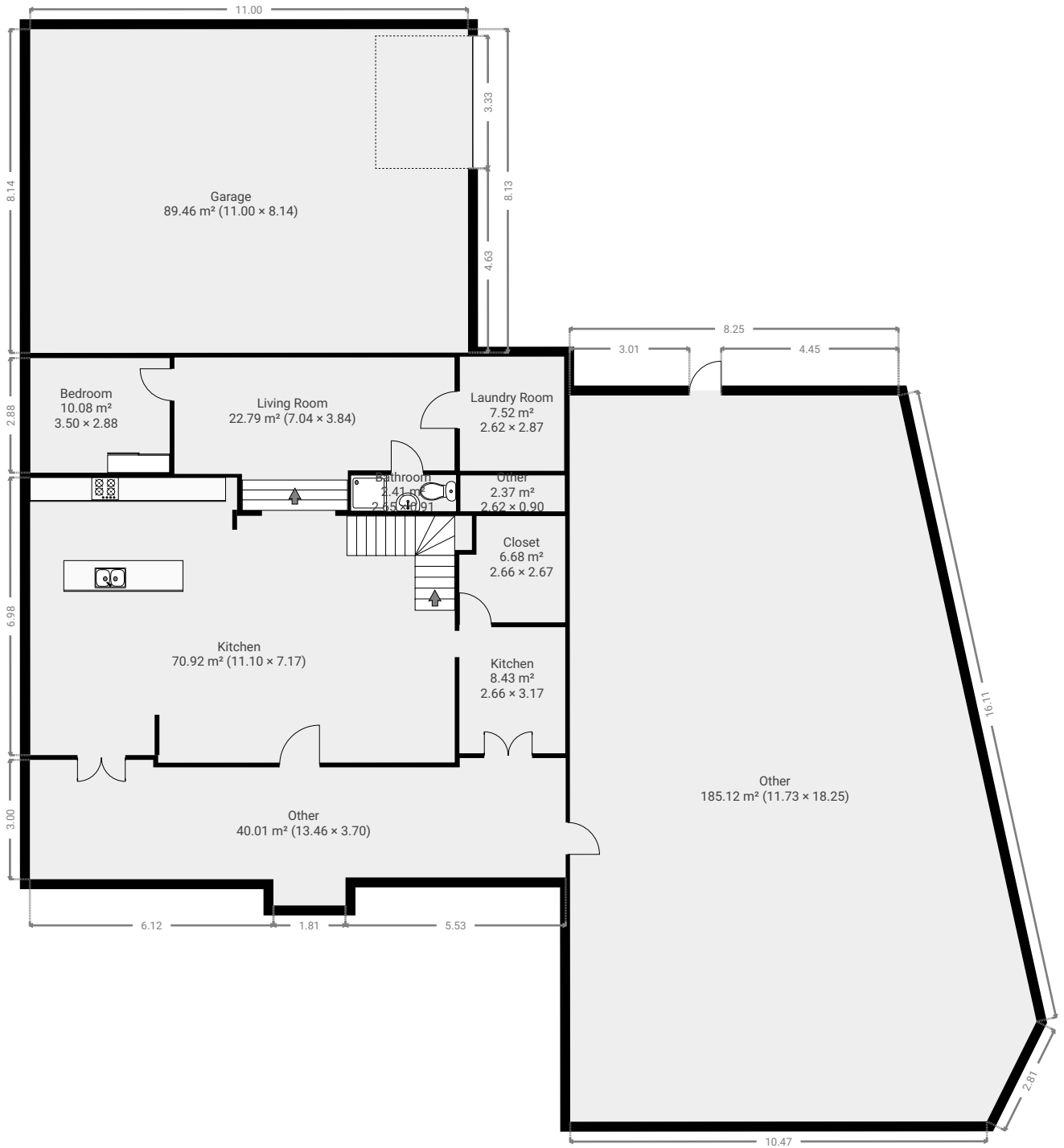

▼ Bathroom  
Ground Floor

WIDTH: 2.65 m • LENGTH: 0.91 m  
AREA: 2.41 m<sup>2</sup> • PERIMETER: 7.12 m

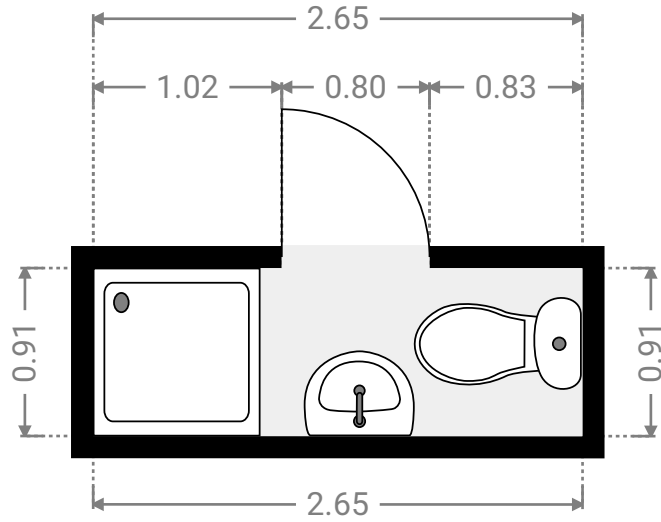
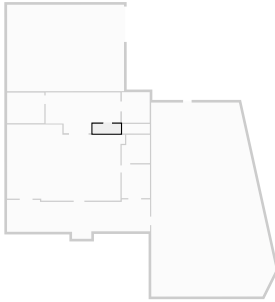

▼ Bedroom  
Ground Floor

WIDTH: 3.50 m • LENGTH: 2.88 m  
AREA: 10.08 m<sup>2</sup> • PERIMETER: 12.76 m

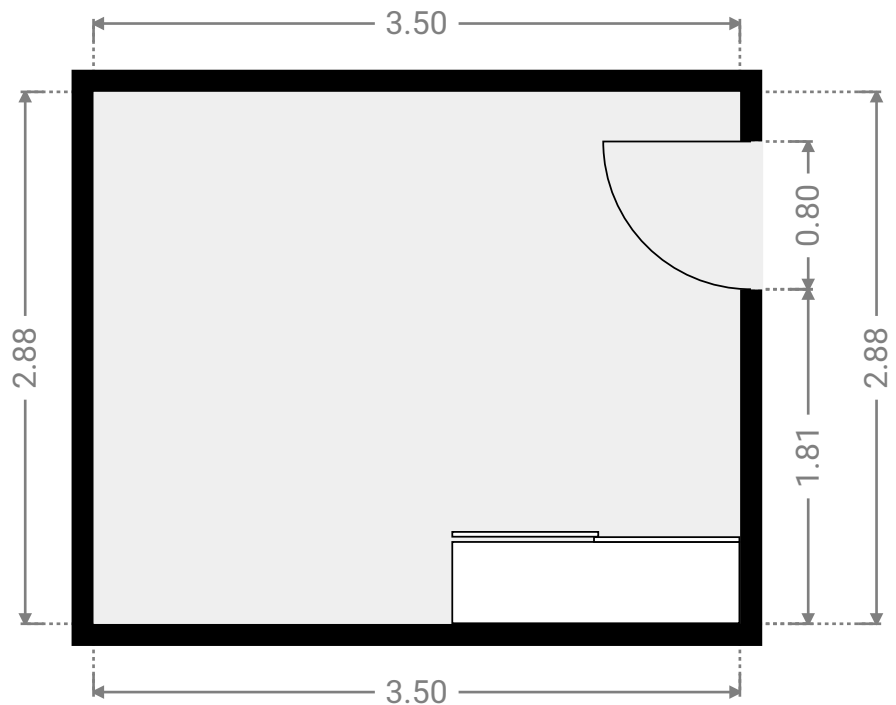
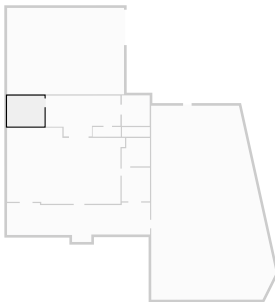

▼ **Garage**  
Ground Floor

WIDTH: 11.00 m • LENGTH: 8.14 m  
AREA: 89.46 m<sup>2</sup> • PERIMETER: 38.27 m

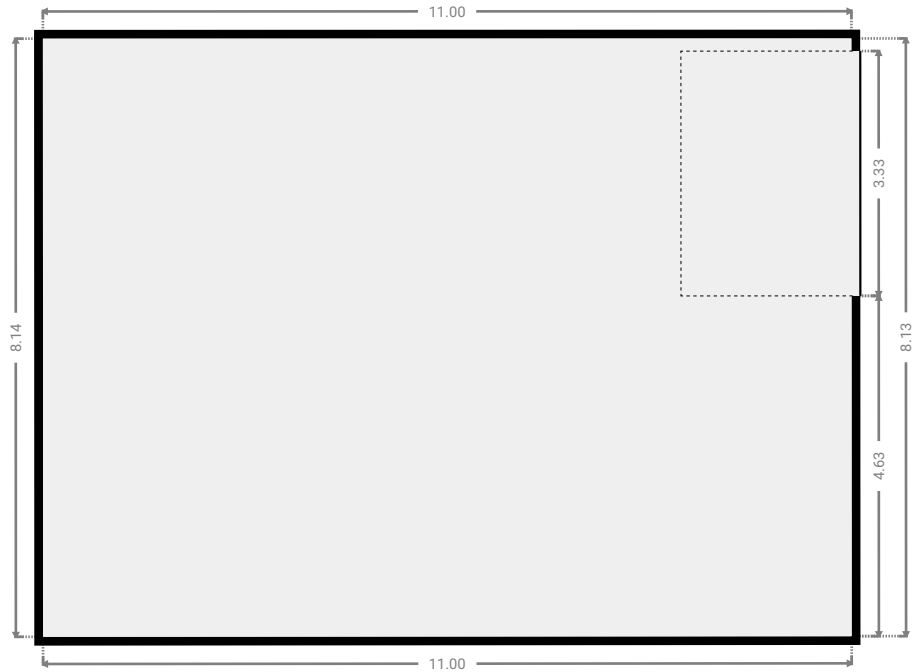
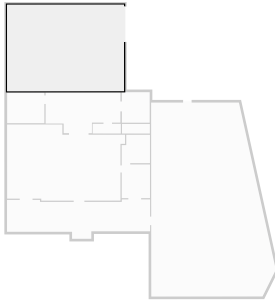

▼ **Kitchen**  
Ground Floor

WIDTH: 11.10 m • LENGTH: 7.17 m  
AREA: 70.92 m<sup>2</sup> • PERIMETER: 36.52 m

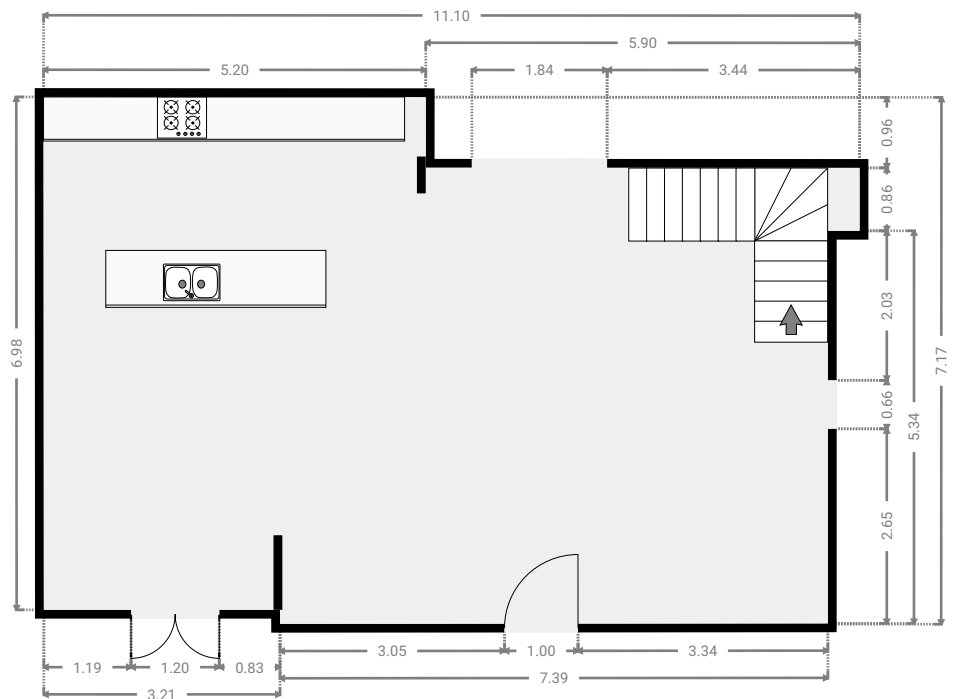
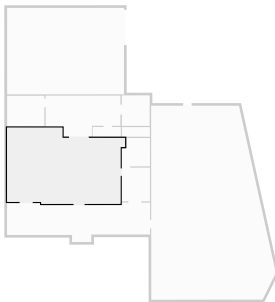

▼ **Kitchen**  
Ground Floor

WIDTH: 2.66 m • LENGTH: 3.17 m  
AREA: 8.43 m<sup>2</sup> • PERIMETER: 11.66 m

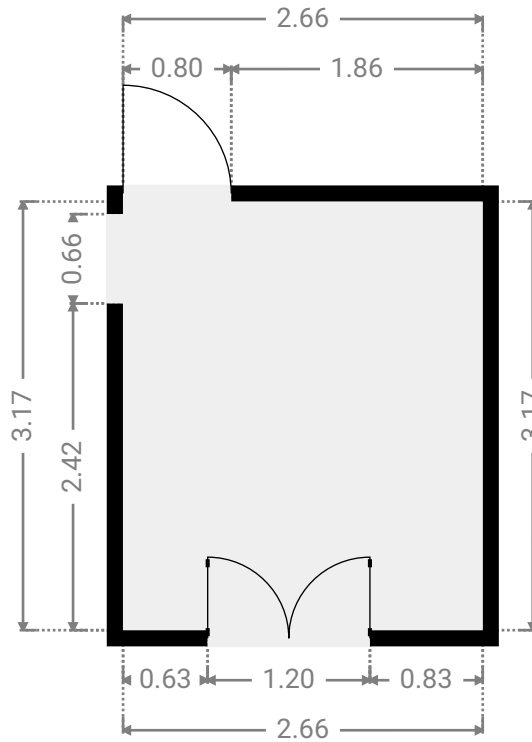
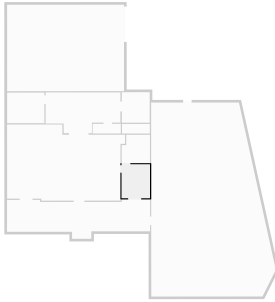

▼ **Closet**  
Ground Floor

WIDTH: 2.66 m • LENGTH: 2.67 m  
AREA: 6.68 m<sup>2</sup> • PERIMETER: 10.66 m

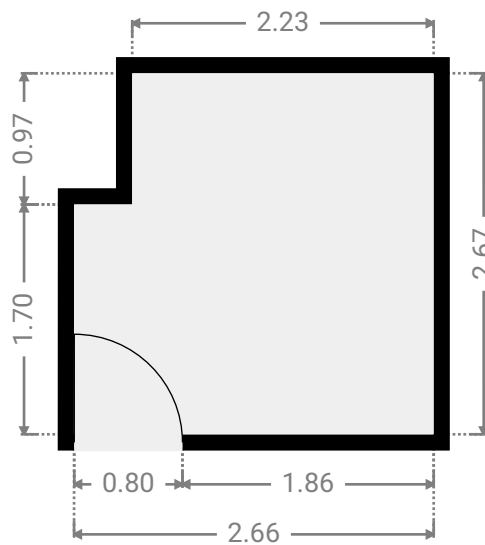
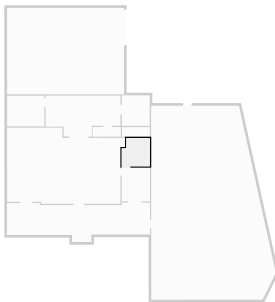

▼ **Laundry Room**  
Ground Floor

WIDTH: 2.62 m • LENGTH: 2.87 m  
AREA: 7.52 m<sup>2</sup> • PERIMETER: 10.98 m

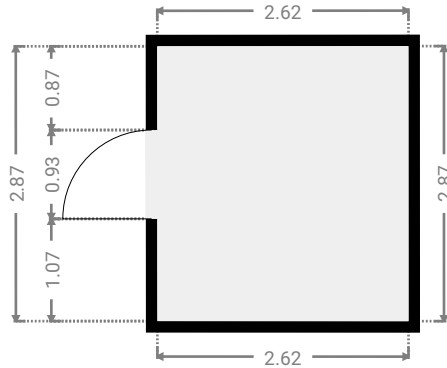
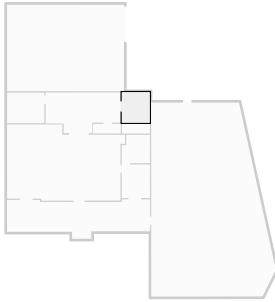

▼ **Living Room**  
Ground Floor

WIDTH: 7.04 m • LENGTH: 3.84 m  
AREA: 22.79 m<sup>2</sup> • PERIMETER: 21.75 m

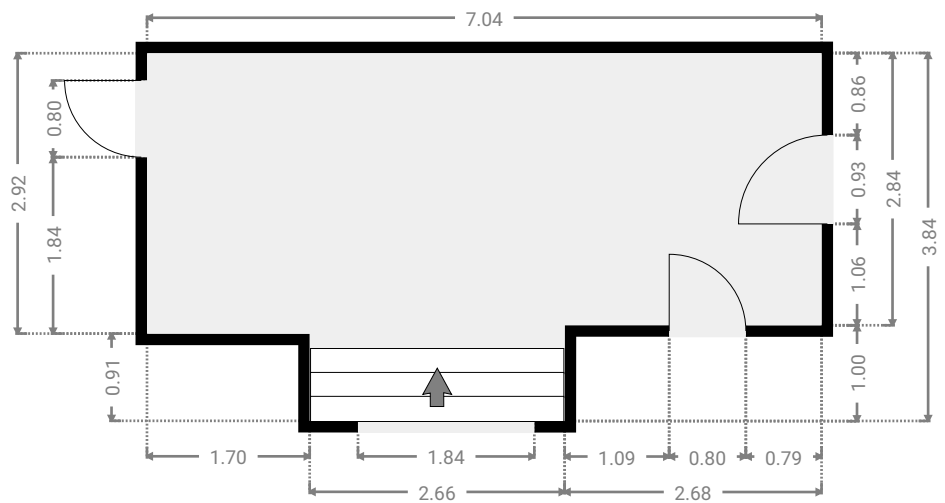
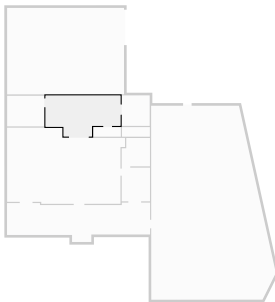

▼ Other  
Ground Floor

WIDTH: 13.46 m • LENGTH: 3.70 m  
AREA: 40.01 m<sup>2</sup> • PERIMETER: 34.71 m

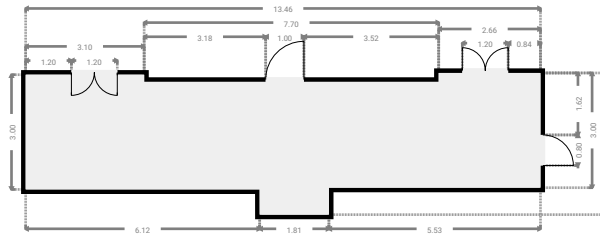
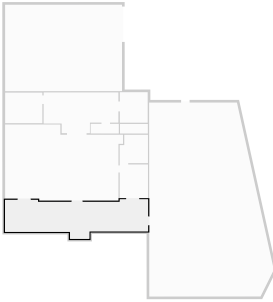

▼ Other  
Ground Floor

WIDTH: 11.73 m • LENGTH: 18.25 m  
AREA: 185.12 m<sup>2</sup> • PERIMETER: 55.90 m

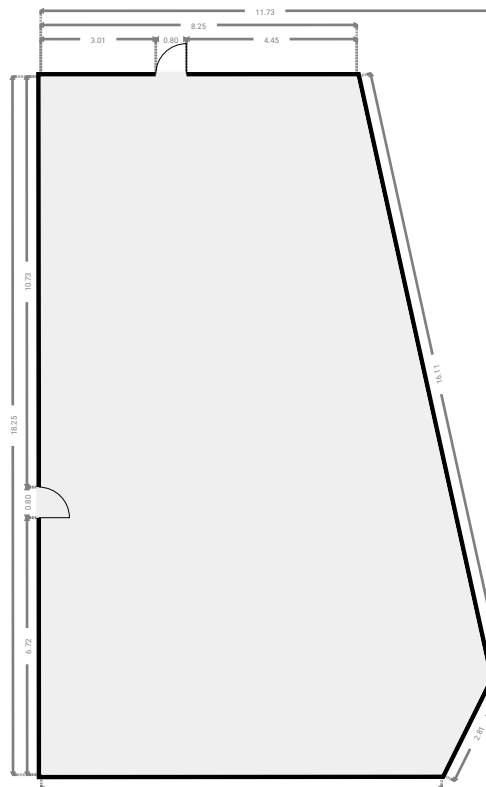
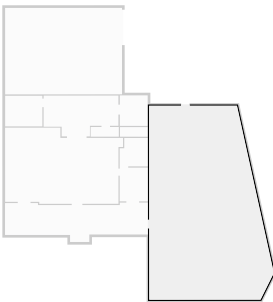

▼ Other  
Ground Floor

WIDTH: 2.62 m • LENGTH: 0.90 m  
AREA: 2.37 m<sup>2</sup> • PERIMETER: 7.05 m

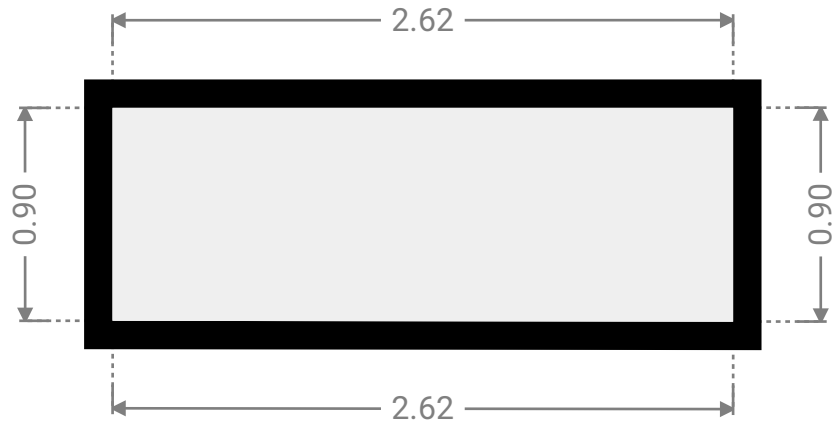
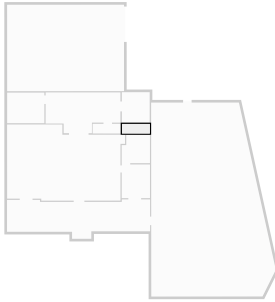



▼ 1st Floor

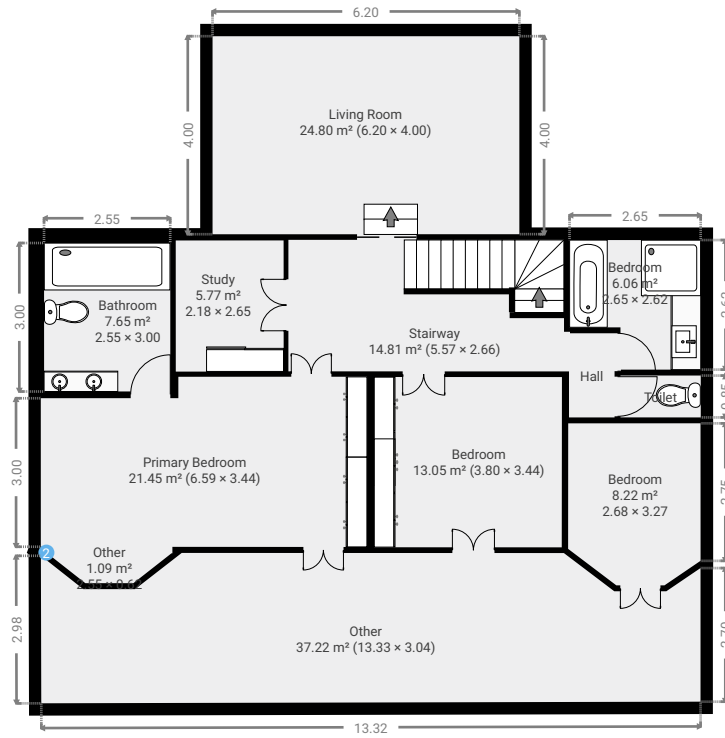

▼ **Bathroom**  
1st Floor

WIDTH: 2.55 m • LENGTH: 3.00 m  
AREA: 7.65 m<sup>2</sup> • PERIMETER: 11.10 m

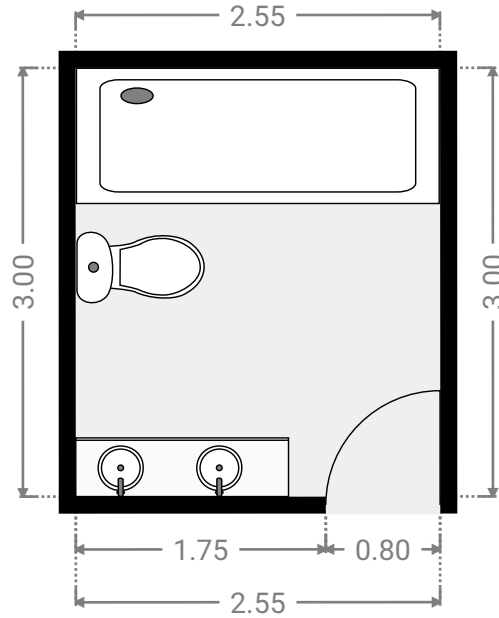
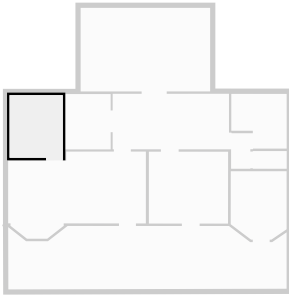

▼ **Bedroom**  
1st Floor

WIDTH: 3.80 m • LENGTH: 3.44 m  
AREA: 13.05 m<sup>2</sup> • PERIMETER: 14.47 m

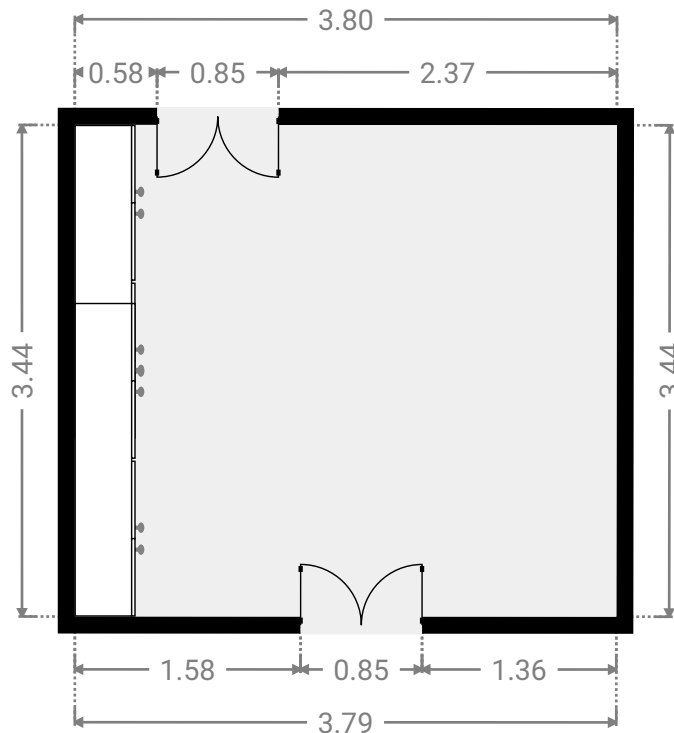
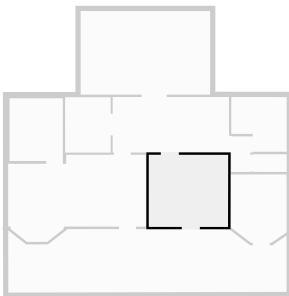

▼ **Bedroom**  
1st Floor

WIDTH: 2.65 m • LENGTH: 2.62 m  
AREA: 6.06 m<sup>2</sup> • PERIMETER: 10.54 m

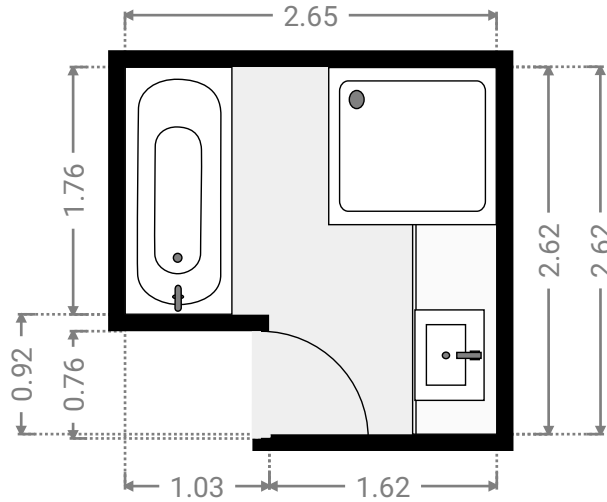
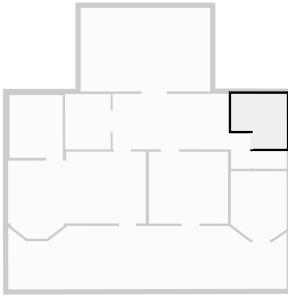

▼ **Bedroom**  
1st Floor

WIDTH: 2.68 m • LENGTH: 3.27 m  
AREA: 8.22 m<sup>2</sup> • PERIMETER: 11.06 m

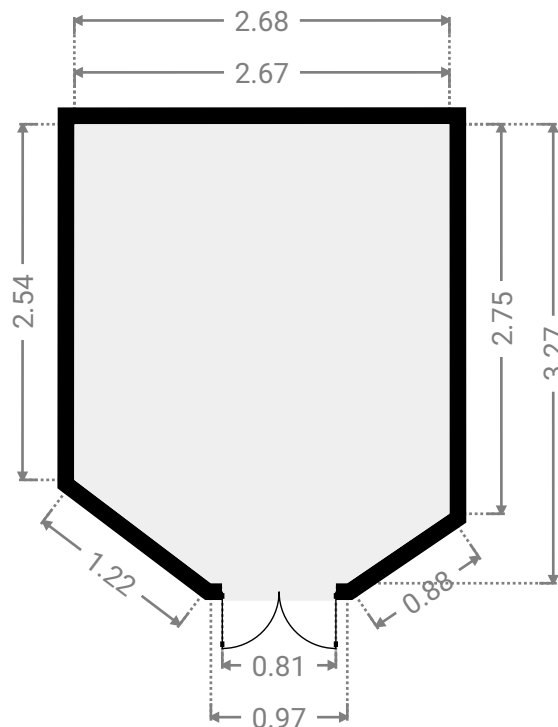
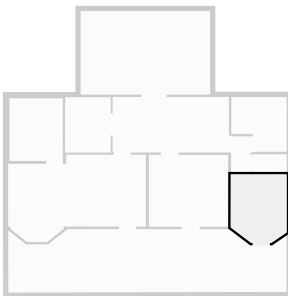

▼ **Hall**  
1st Floor

WIDTH: 0.92 m • LENGTH: 1.70 m  
AREA: 1.56 m<sup>2</sup> • PERIMETER: 5.24 m

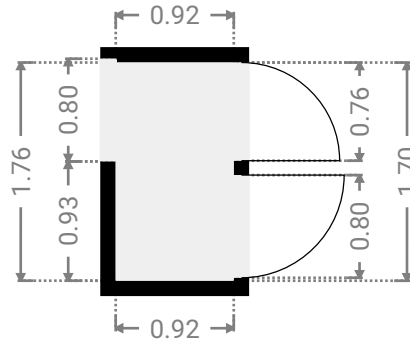
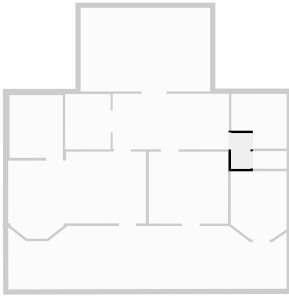

▼ **Living Room**  
1st Floor

WIDTH: 6.20 m • LENGTH: 4.00 m  
AREA: 24.80 m<sup>2</sup> • PERIMETER: 20.40 m

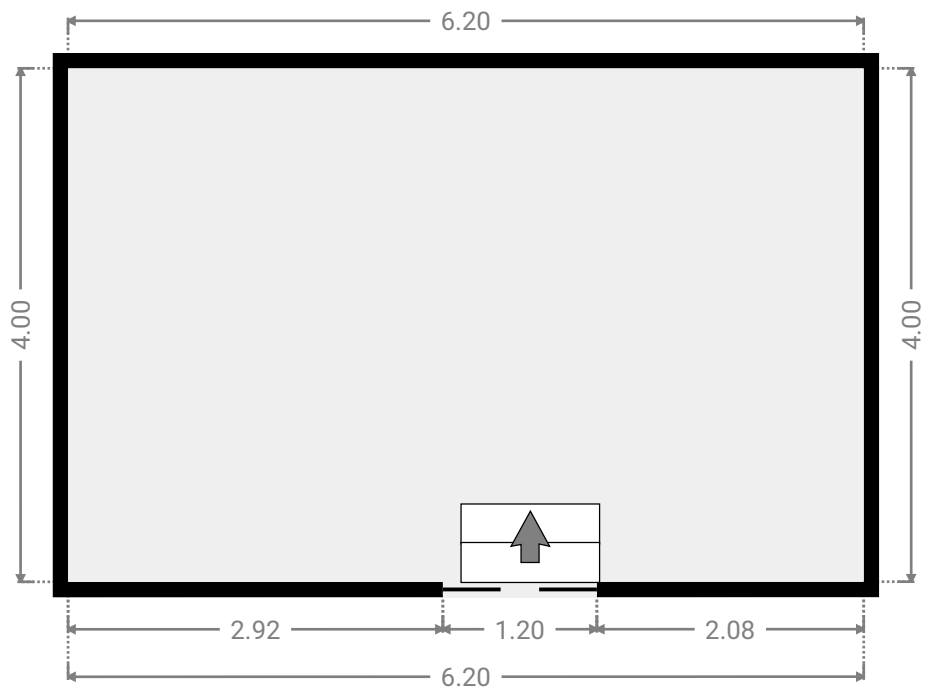
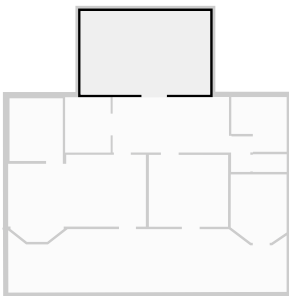

▼ **Other**  
1st Floor

WIDTH: 2.55 m • LENGTH: 0.62 m  
AREA: 1.09 m<sup>2</sup> • PERIMETER: 5.52 m

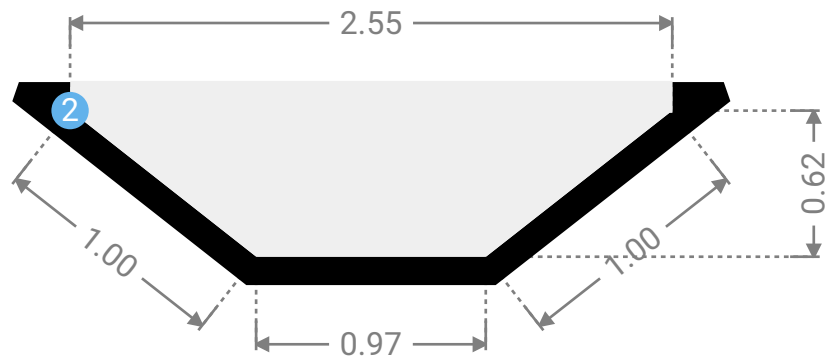
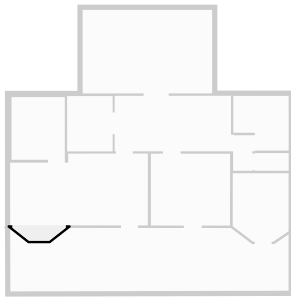

▼ **Other/1st Floor**

**2 OPENING**

Height  
0.00 m



▼ Other  
1st Floor

WIDTH: 13.33 m • LENGTH: 3.04 m  
AREA: 37.22 m<sup>2</sup> • PERIMETER: 33.22 m

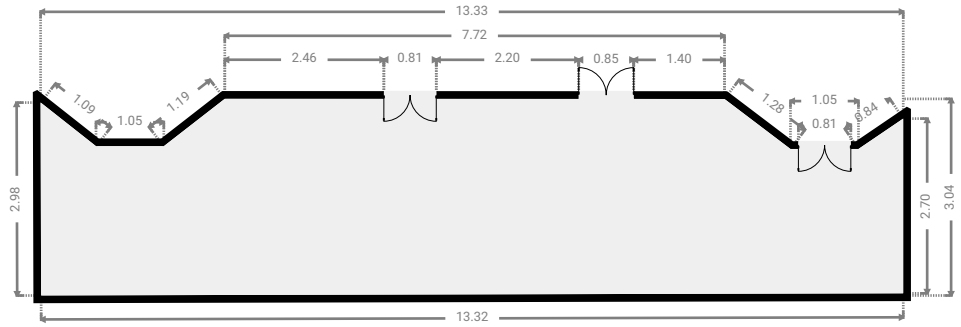
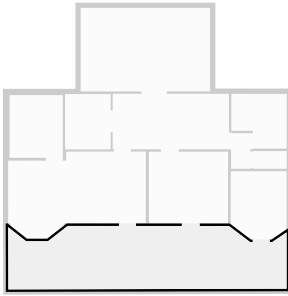

▼ Primary Bedroom  
1st Floor

WIDTH: 6.59 m • LENGTH: 3.44 m  
AREA: 21.45 m<sup>2</sup> • PERIMETER: 20.06 m

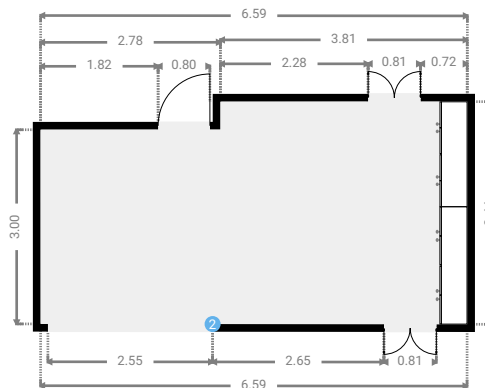
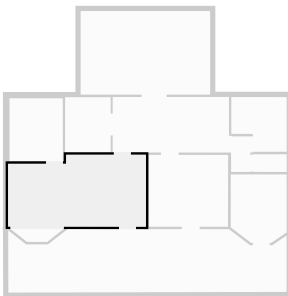

▼ **Stairway**  
1st Floor

WIDTH: 5.57 m • LENGTH: 2.66 m  
AREA: 14.81 m<sup>2</sup> • PERIMETER: 16.46 m

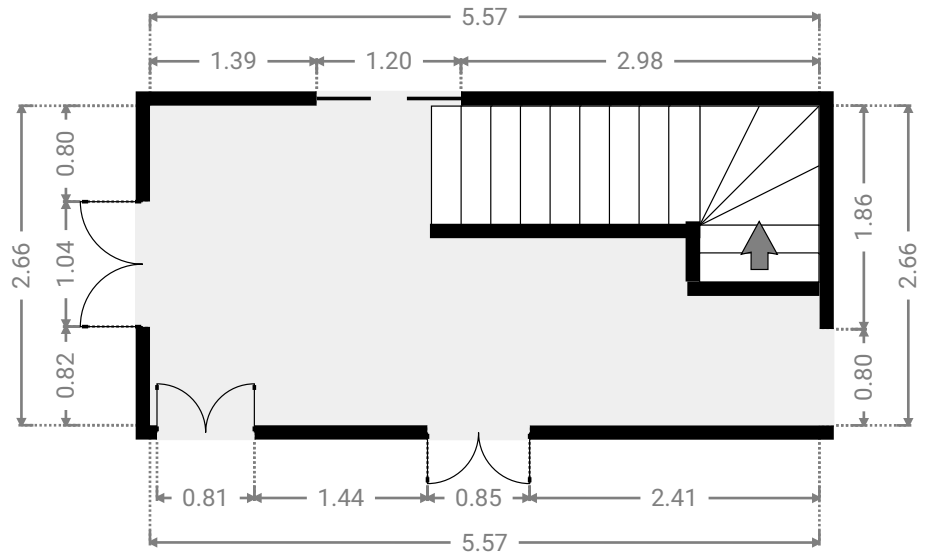
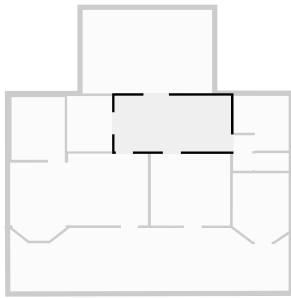

▼ **Study**  
1st Floor

WIDTH: 2.18 m • LENGTH: 2.65 m  
AREA: 5.77 m<sup>2</sup> • PERIMETER: 9.66 m

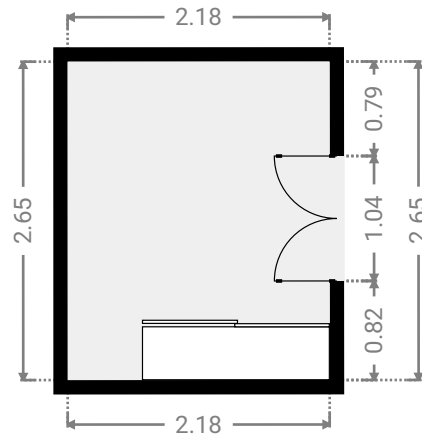
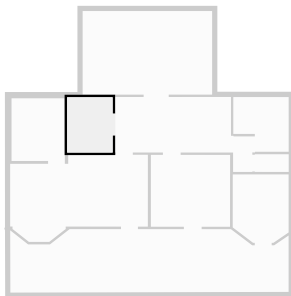

▼ Toilet  
1st Floor

WIDTH: 1.62 m • LENGTH: 0.85 m  
AREA: 1.37 m<sup>2</sup> • PERIMETER: 4.93 m

