

60 Rundle Street

Ground Floor



THIS FLOORPLAN IS PROVIDED WITHOUT WARRANTY OF ANY KIND. SENSOPIA DISCLAIMS ANY WARRANTY INCLUDING, WITHOUT LIMITATION, SATISFACTORY QUALITY OR ACCURACY OF DIMENSIONS.

60 Rundle Street

Master Bedroom

Width: 3.90 m
 Length: 4.79 m
 Area: 18.67 m²
 Perimeter: 17.37 m

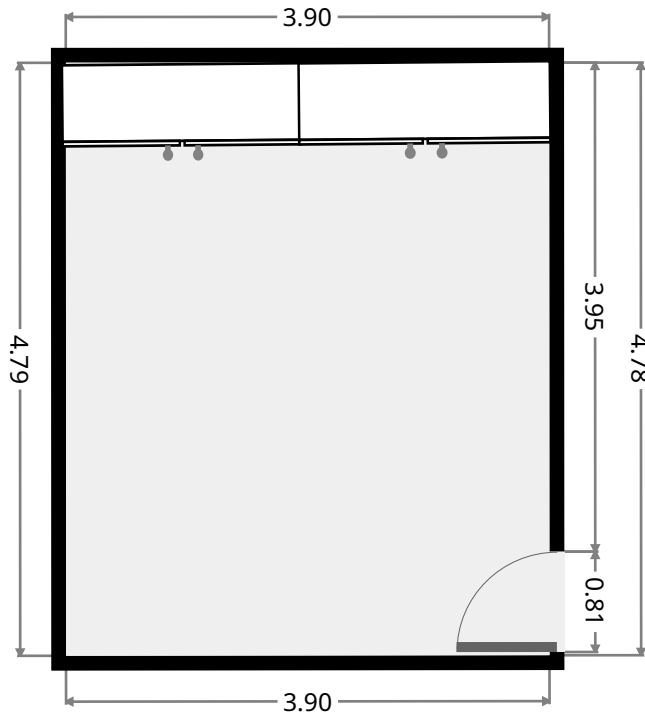
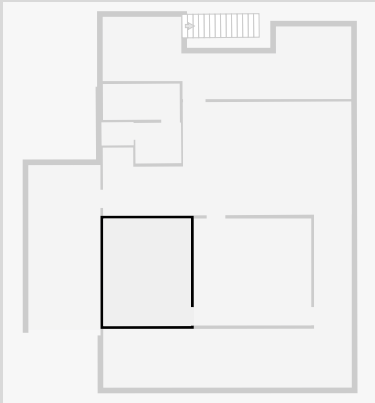

Living Room

Width: 4.76 m
 Length: 5.23 m
 Area: 24.90 m²
 Perimeter: 19.98 m

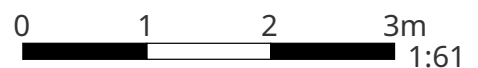
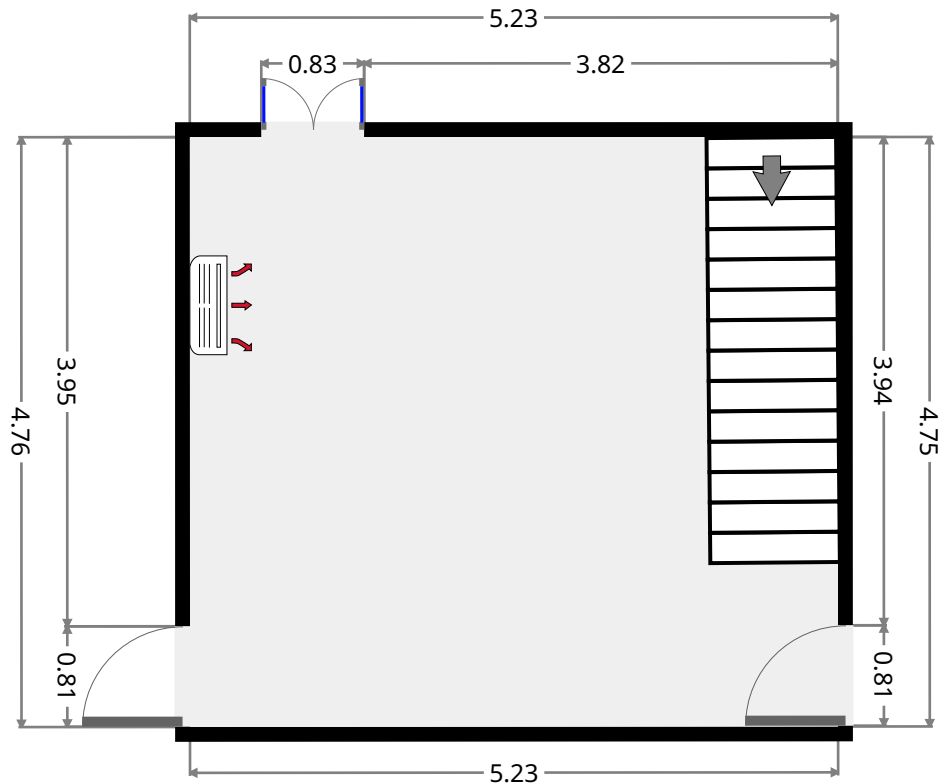
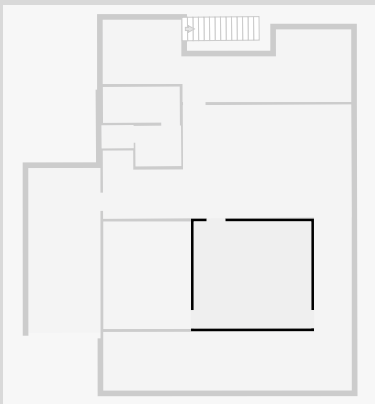

THIS FLOORPLAN IS PROVIDED WITHOUT WARRANTY OF ANY KIND. SENSOPIA DISCLAIMS ANY WARRANTY INCLUDING, WITHOUT LIMITATION, SATISFACTORY QUALITY OR ACCURACY OF DIMENSIONS.

60 Rundle Street

•
Width: 5.05 m
Length: 11.07 m
Area: 46.69 m²
Perimeter: 33.92 m

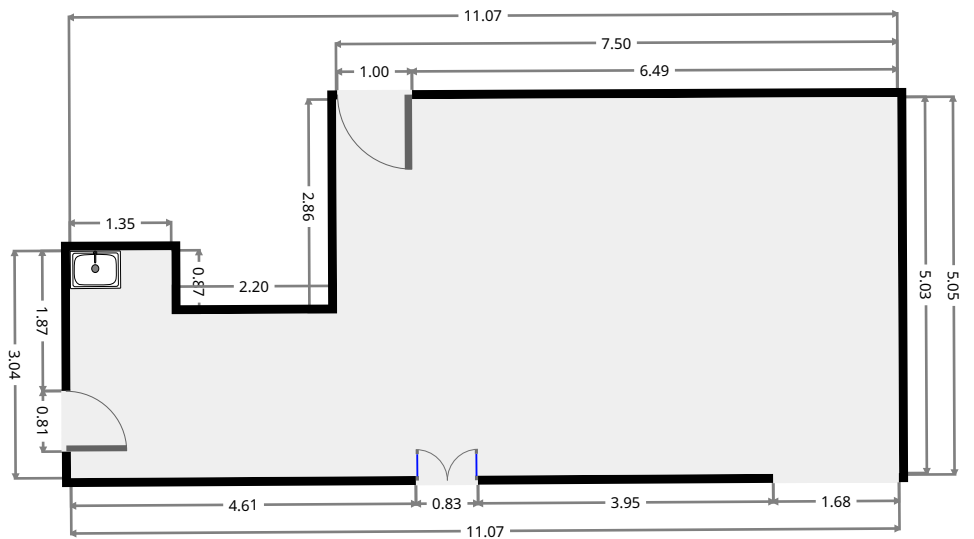
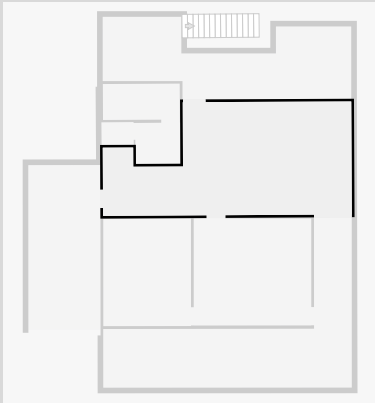

THIS FLOORPLAN IS PROVIDED WITHOUT WARRANTY OF ANY KIND. SENSOPIA DISCLAIMS ANY WARRANTY INCLUDING, WITHOUT LIMITATION, SATISFACTORY QUALITY OR ACCURACY OF DIMENSIONS.

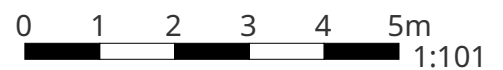

60 Rundle Street

Hall

Width: 1.81 m
Length: 2.04 m
Area: 3.68 m²
Perimeter: 7.69 m

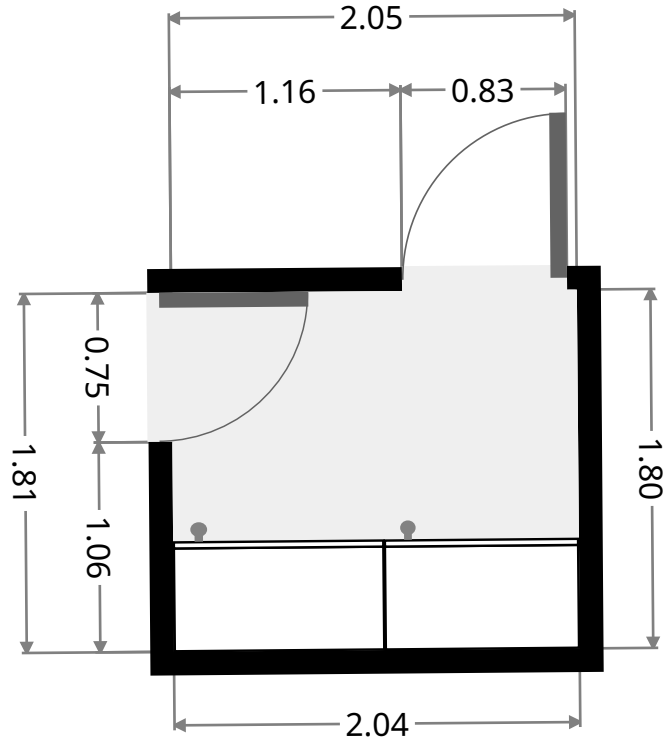
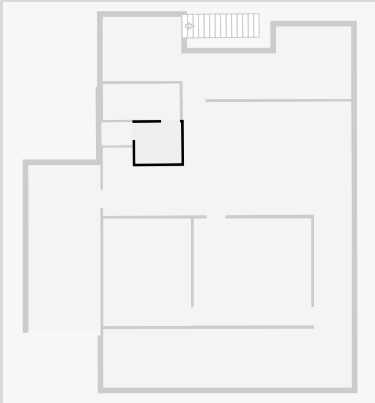

Toilet / Half Bath

Width: 1.03 m
Length: 1.43 m
Area: 1.48 m²
Perimeter: 4.93 m

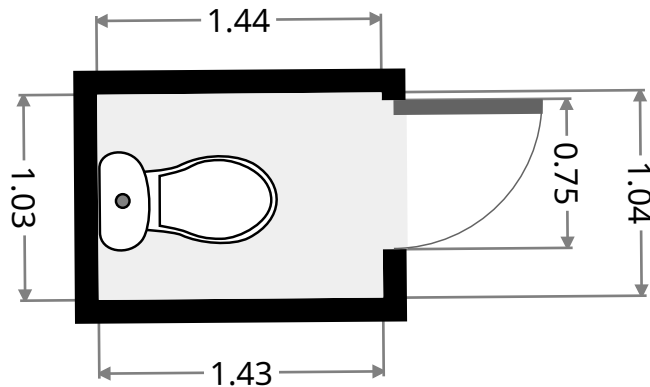
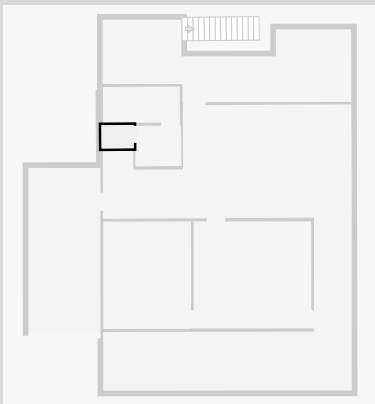

60 Rundle Street

Bathroom

Width: 1.60 m
 Length: 3.42 m
 Area: 5.47 m²
 Perimeter: 10.04 m

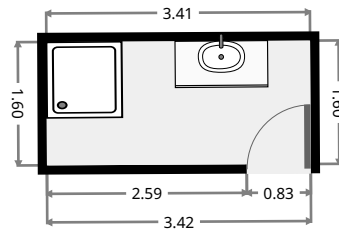
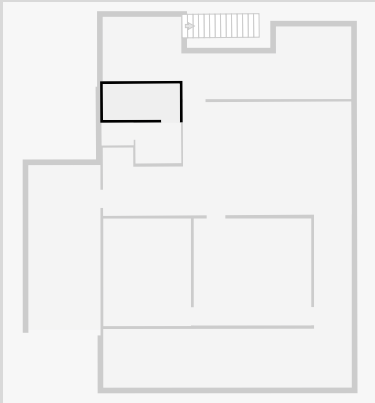

Width: 3.67 m
 Length: 11.06 m
 Area: 29.36 m²
 Perimeter: 31.84 m

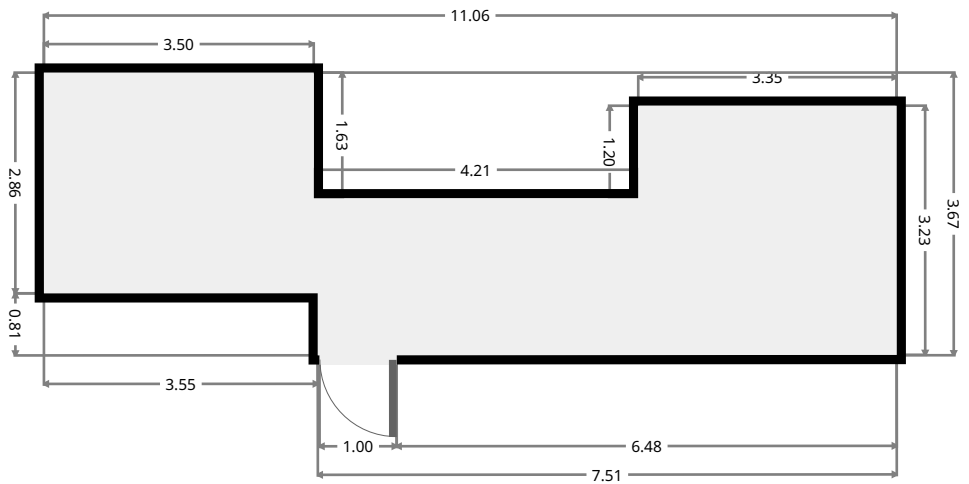
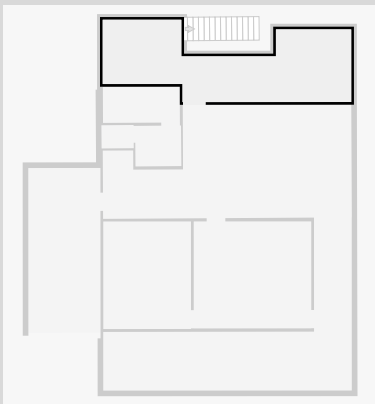

THIS FLOORPLAN IS PROVIDED WITHOUT WARRANTY OF ANY KIND. SENSOPIA DISCLAIMS ANY WARRANTY INCLUDING, WITHOUT LIMITATION, SATISFACTORY QUALITY OR ACCURACY OF DIMENSIONS.

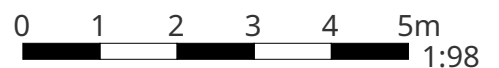

60 Rundle Street

•
Width: 7.59 m
Length: 11.07 m
Area: 37.27 m²
Perimeter: 37.29 m

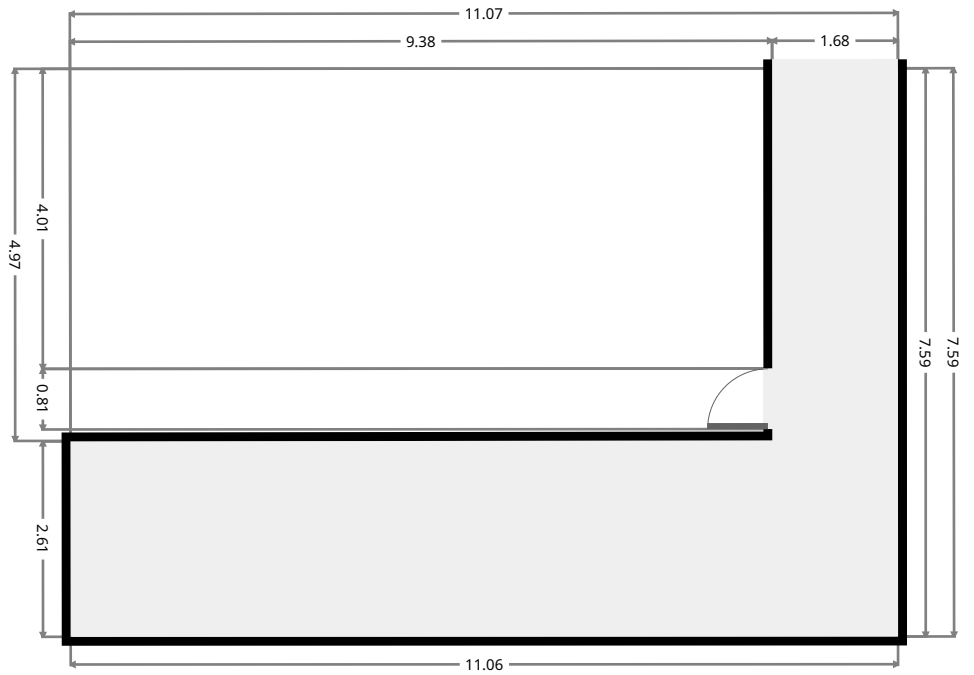
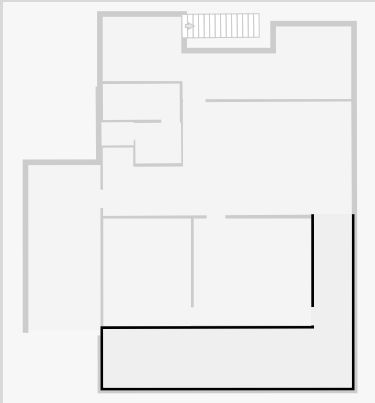

THIS FLOORPLAN IS PROVIDED WITHOUT WARRANTY OF ANY KIND. SENSOPIA DISCLAIMS ANY WARRANTY INCLUDING, WITHOUT LIMITATION, SATISFACTORY QUALITY OR ACCURACY OF DIMENSIONS.

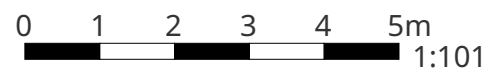

60 Rundle Street

Garage

Width: 3.21 m
Length: 7.21 m
Area: 23.14 m²
Perimeter: 20.84 m

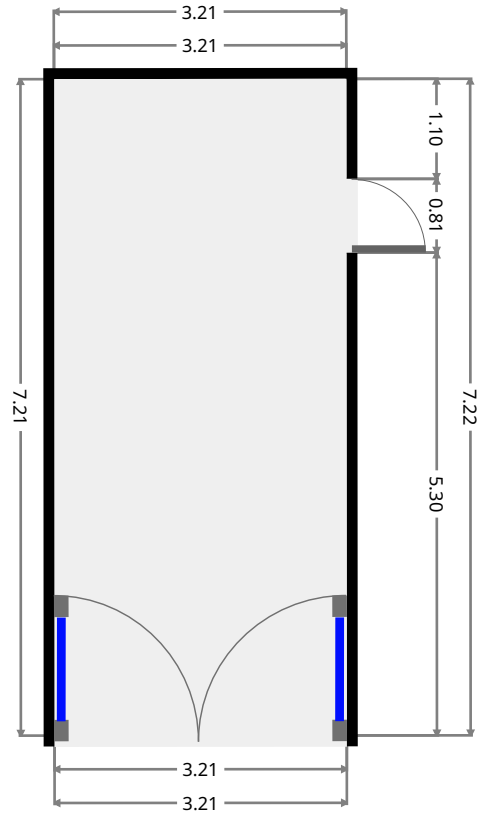
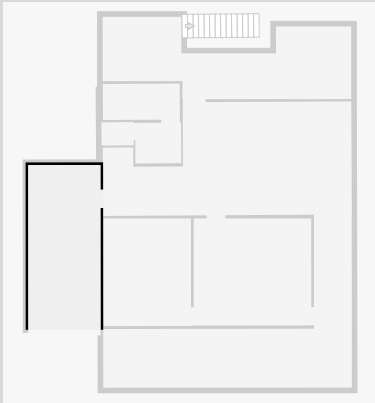

60 Rundle Street

1st Floor

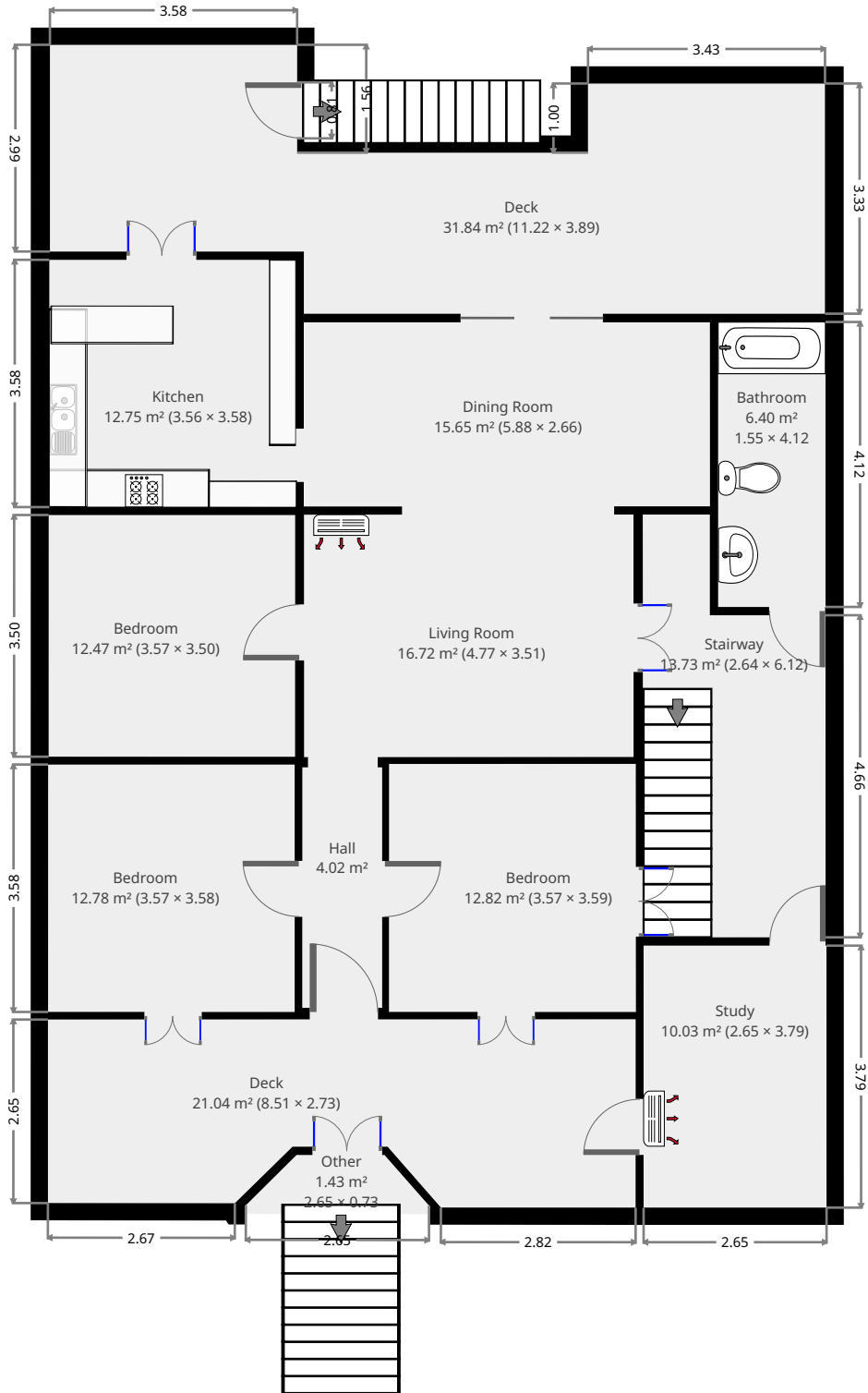

THIS FLOORPLAN IS PROVIDED WITHOUT WARRANTY OF ANY KIND. SENSOPIA DISCLAIMS ANY WARRANTY INCLUDING, WITHOUT LIMITATION, SATISFACTORY QUALITY OR ACCURACY OF DIMENSIONS.



60 Rundle Street

Hall

Width: 1.16 m
 Length: 3.48 m
 Area: 4.02 m²
 Perimeter: 9.27 m

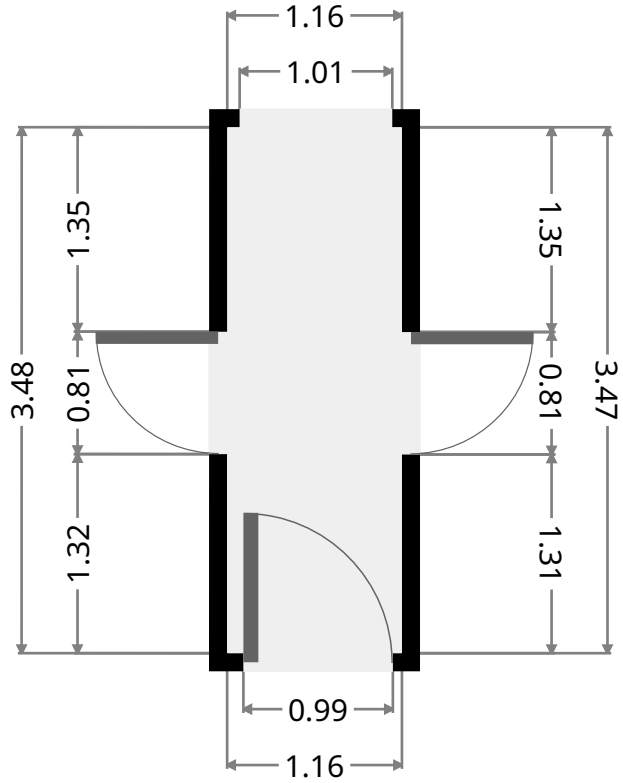
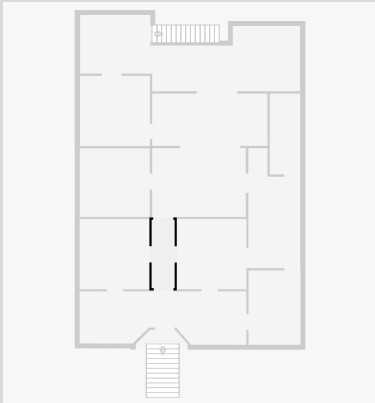

Bedroom

Width: 3.57 m
 Length: 3.59 m
 Area: 12.82 m²
 Perimeter: 14.32 m

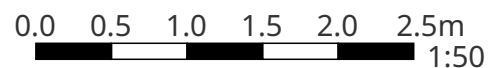
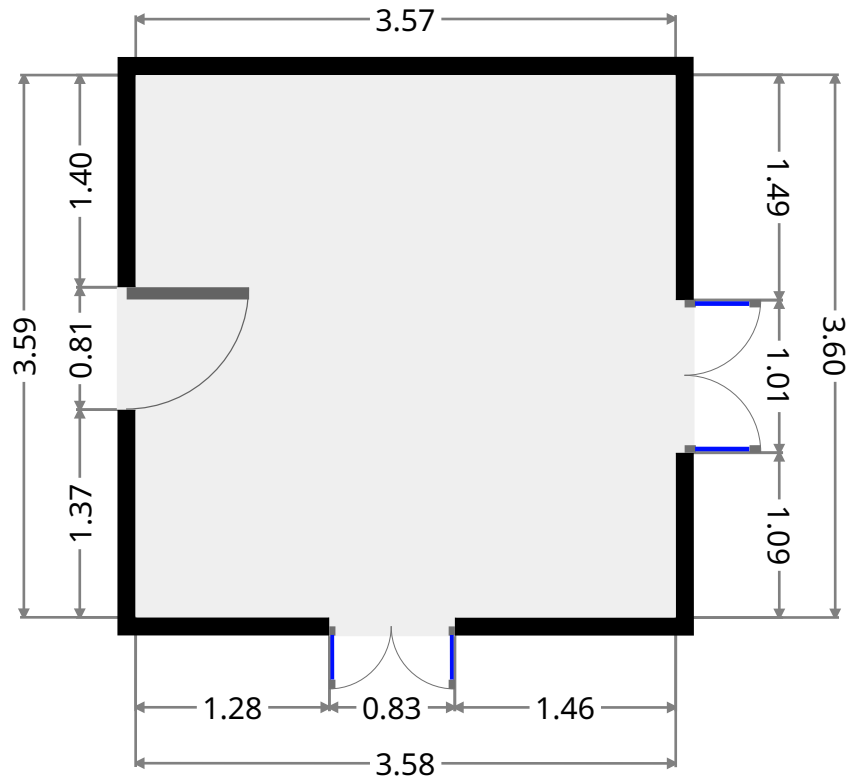
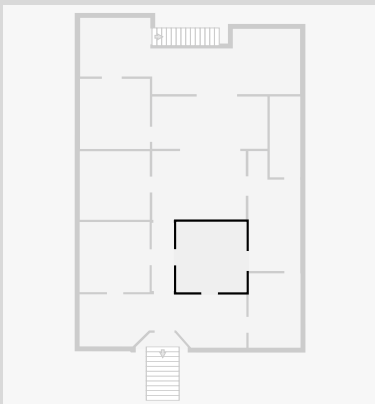

THIS FLOORPLAN IS PROVIDED WITHOUT WARRANTY OF ANY KIND. SENSOPIA DISCLAIMS ANY WARRANTY INCLUDING, WITHOUT LIMITATION, SATISFACTORY QUALITY OR ACCURACY OF DIMENSIONS.

60 Rundle Street

Bedroom

Width: 3.57 m
 Length: 3.58 m
 Area: 12.78 m²
 Perimeter: 14.30 m

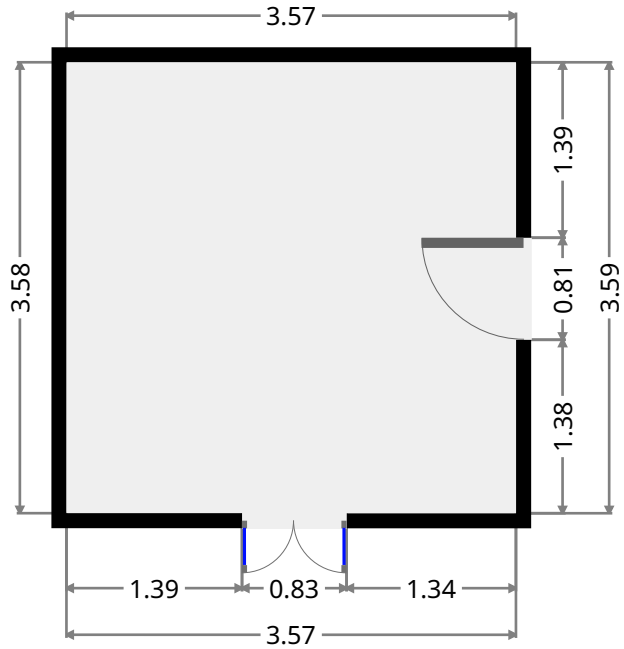
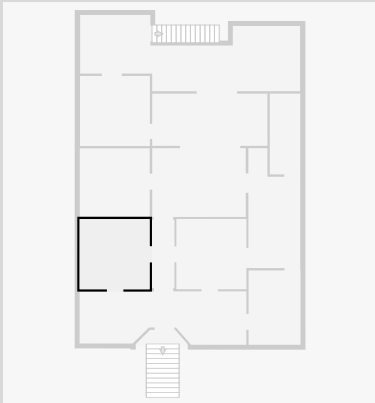

Living Room

Width: 3.51 m
 Length: 4.77 m
 Area: 16.72 m²
 Perimeter: 16.55 m

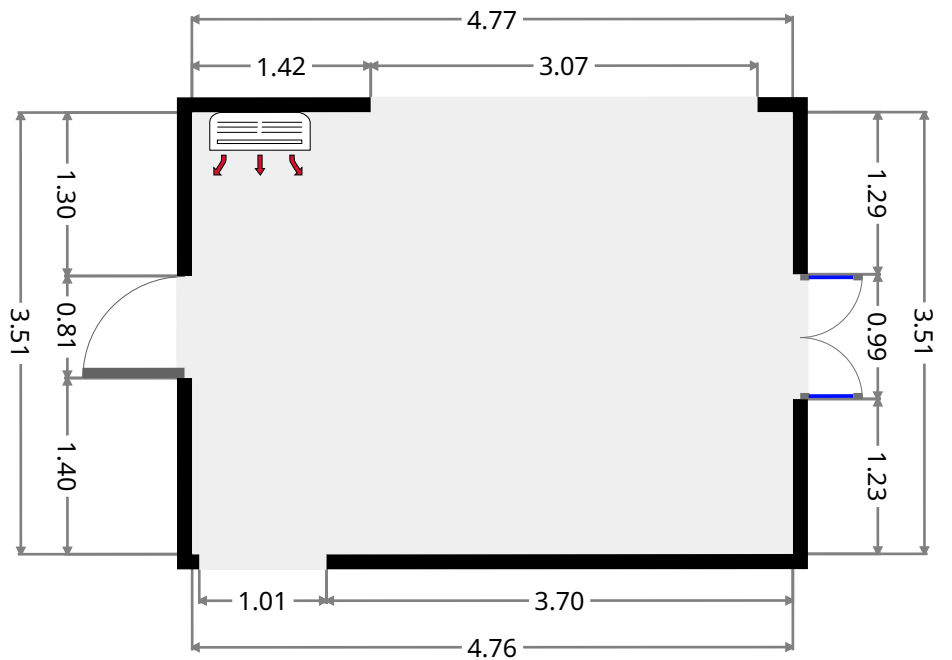
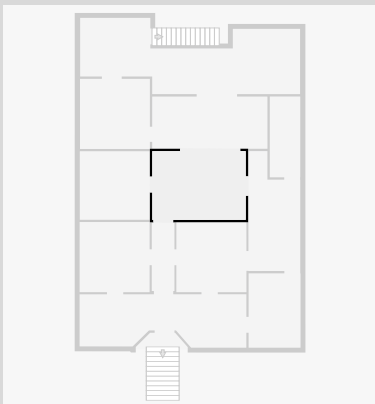

60 Rundle Street

Bedroom

Width: 3.50 m
 Length: 3.57 m
 Area: 12.47 m²
 Perimeter: 14.13 m

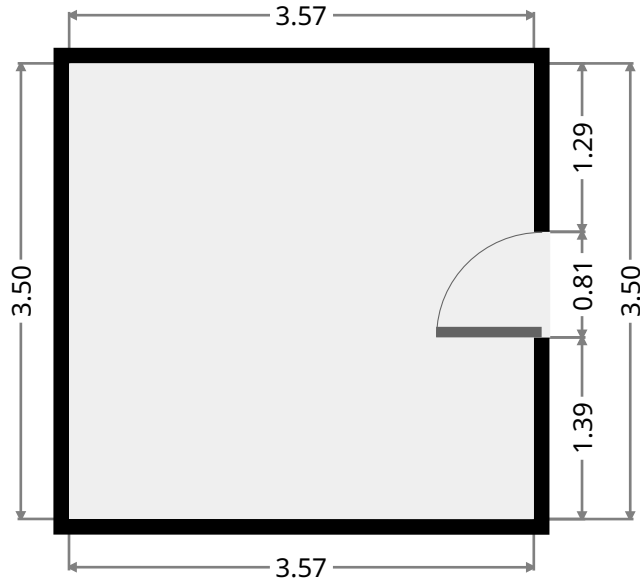
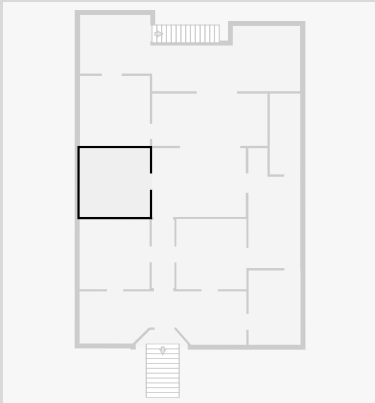

Dining Room

Width: 2.66 m
 Length: 5.88 m
 Area: 15.65 m²
 Perimeter: 17.08 m

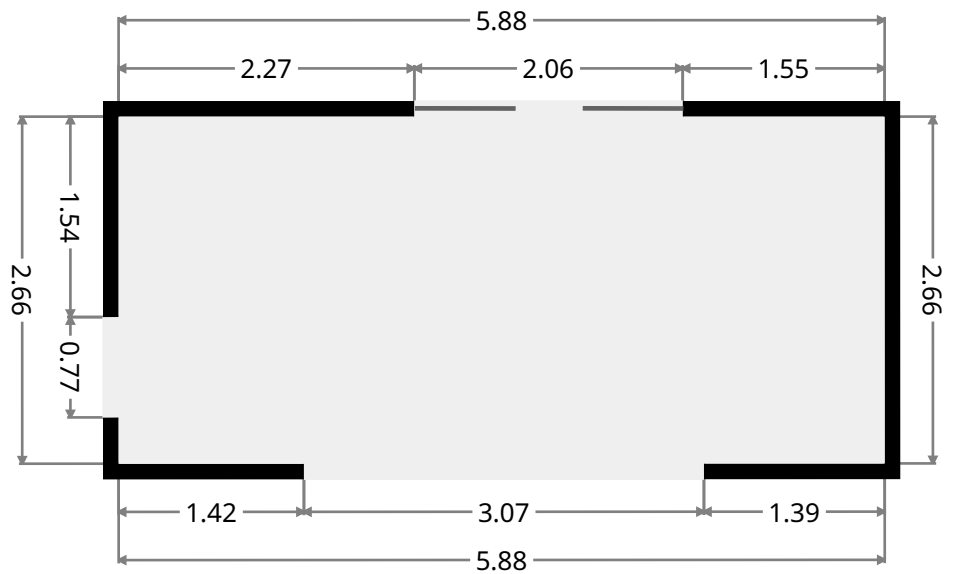
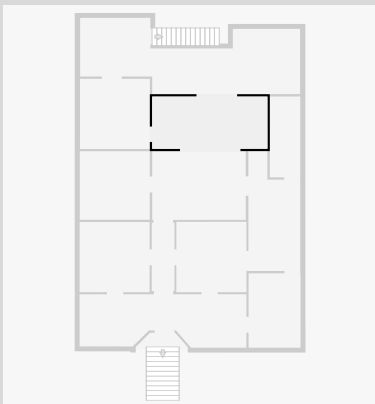

60 Rundle Street

Kitchen

Width: 3.56 m
 Length: 3.58 m
 Area: 12.75 m²
 Perimeter: 14.28 m

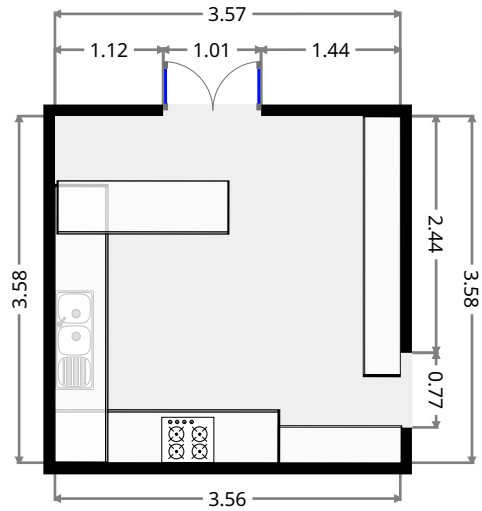
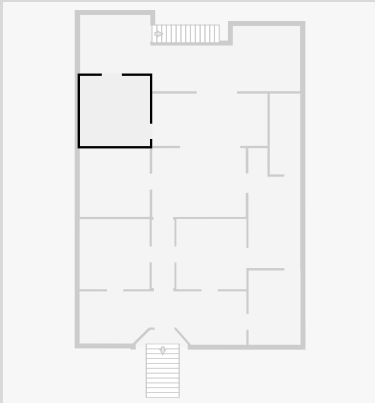

Deck

Width: 2.73 m
 Length: 8.51 m
 Area: 21.04 m²
 Perimeter: 23.13 m

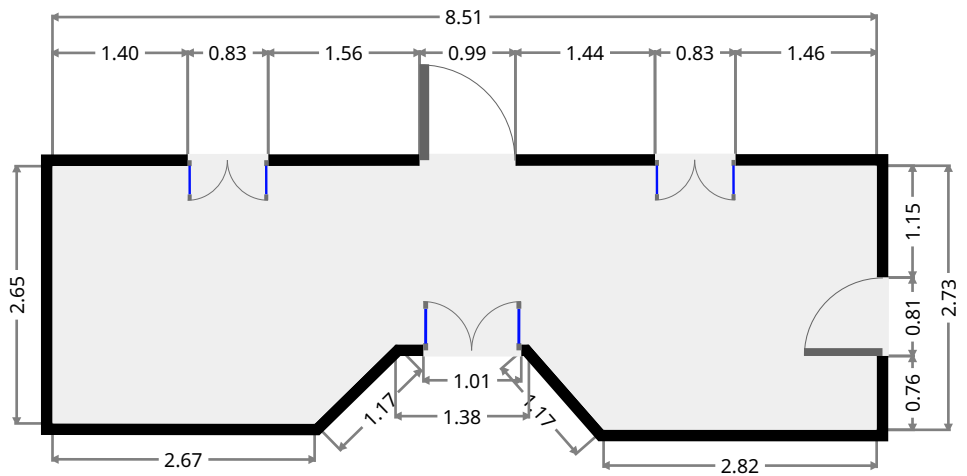
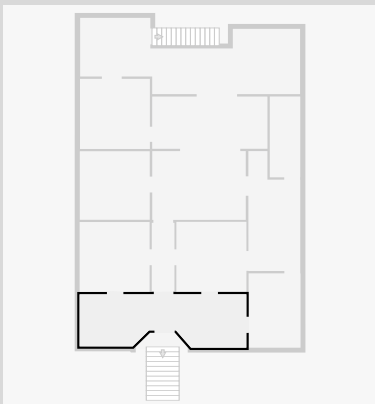

THIS FLOORPLAN IS PROVIDED WITHOUT WARRANTY OF ANY KIND. SENSOPIA DISCLAIMS ANY WARRANTY INCLUDING, WITHOUT LIMITATION, SATISFACTORY QUALITY OR ACCURACY OF DIMENSIONS.



60 Rundle Street

Study

Width: 2.65 m
 Length: 3.79 m
 Area: 10.03 m²
 Perimeter: 12.87 m

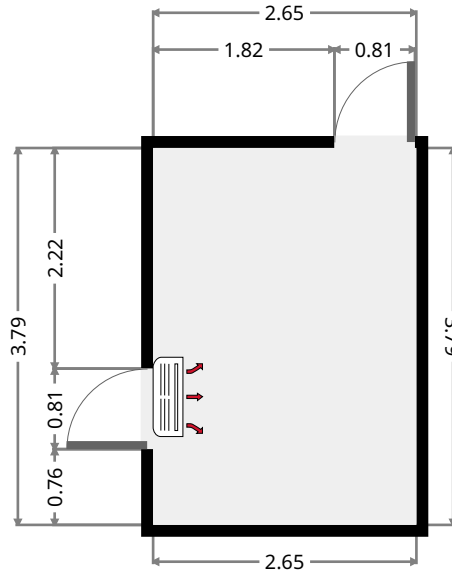
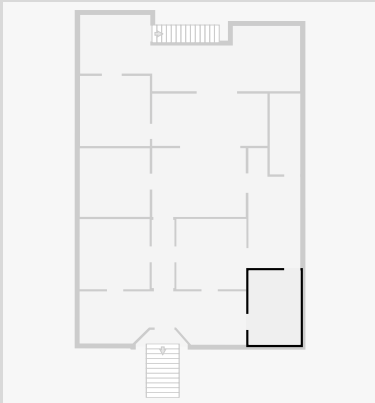

Stairway

Width: 2.64 m
 Length: 6.12 m
 Area: 13.73 m²
 Perimeter: 17.52 m

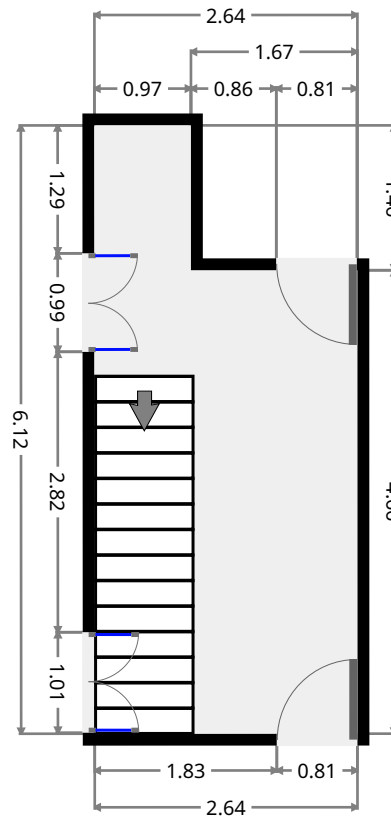
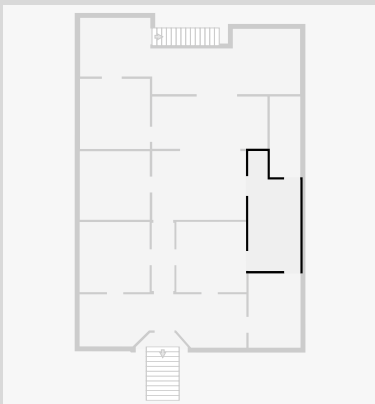

THIS FLOORPLAN IS PROVIDED WITHOUT WARRANTY OF ANY KIND. SENSOPIA DISCLAIMS ANY WARRANTY INCLUDING, WITHOUT LIMITATION, SATISFACTORY QUALITY OR ACCURACY OF DIMENSIONS.

60 Rundle Street

Bathroom

Width: 1.55 m
 Length: 4.12 m
 Area: 6.40 m²
 Perimeter: 11.35 m

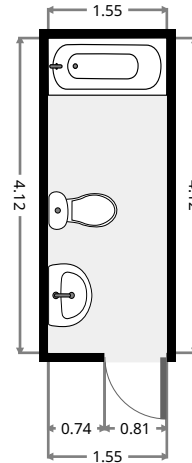
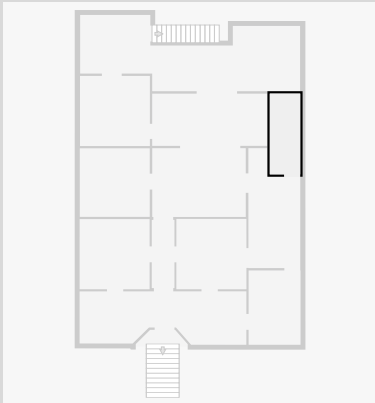

Deck

Width: 3.89 m
 Length: 11.22 m
 Area: 31.84 m²
 Perimeter: 32.22 m

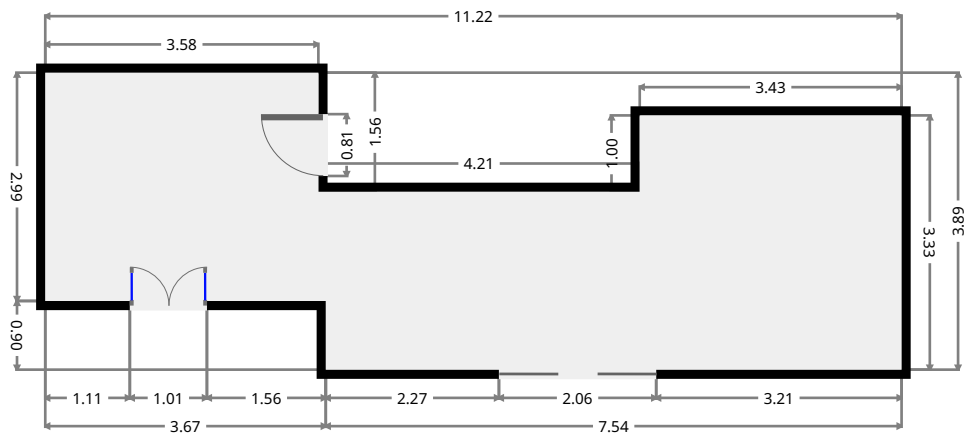
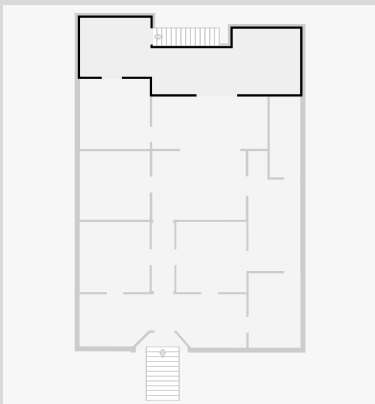

60 Rundle Street

Other

Width:	0.73 m
Length:	2.65 m
Area	1.43 m ²
Perimeter	5.93 m

