

# 60 Pillich Street

Created on  
2020-08-27

Floors  
1

▼ Ground Floor

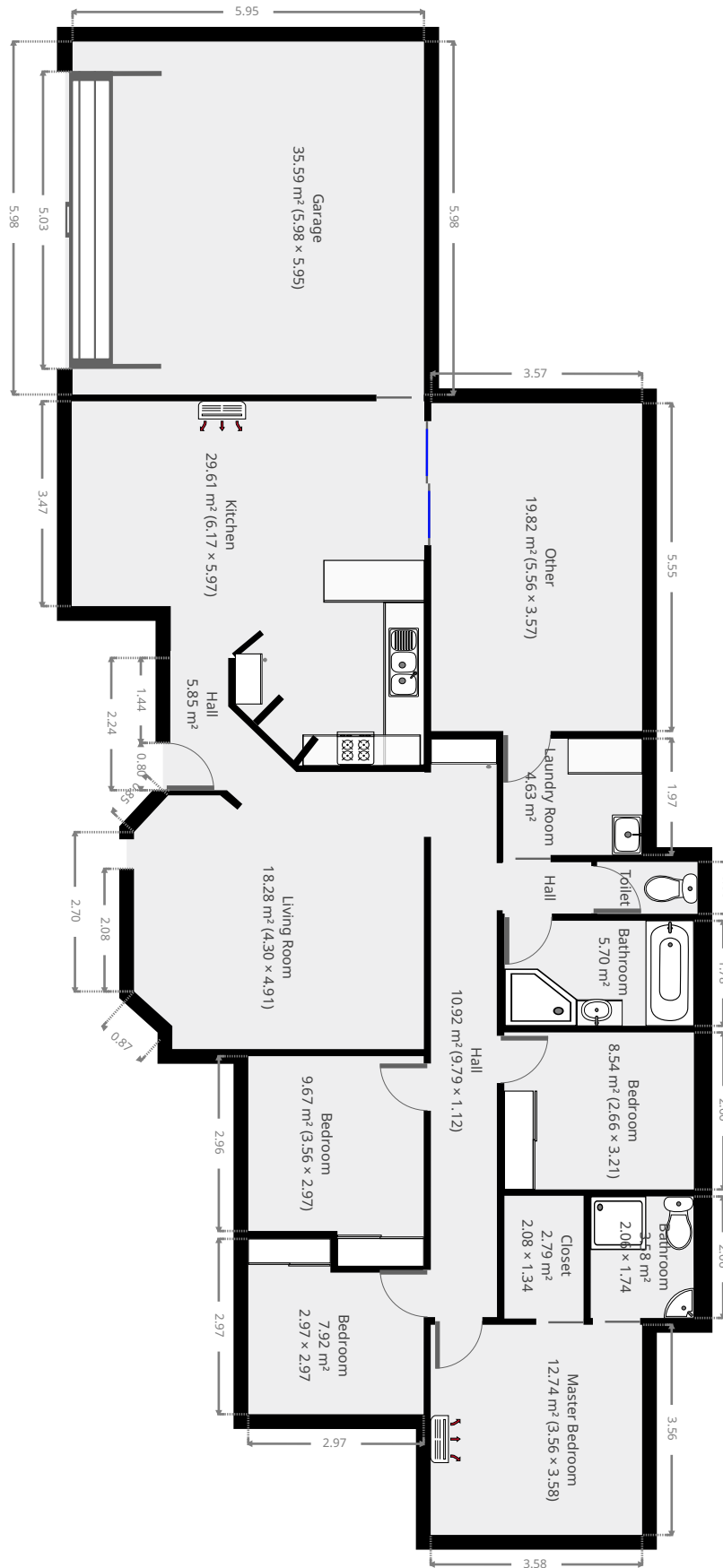

THIS FLOORPLAN IS PROVIDED WITHOUT WARRANTY OF ANY KIND. SENSOPIA DISCLAIMS ANY WARRANTY INCLUDING, WITHOUT LIMITATION, SATISFACTORY QUALITY OR ACCURACY OF DIMENSIONS.

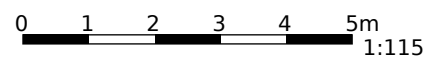

▼ **Hall**  
Ground Floor

**WIDTH:** 2.91 m • **LENGTH:** 4.30 m  
**AREA:** 5.85 m<sup>2</sup> • **PERIMETER:** 13.35 m

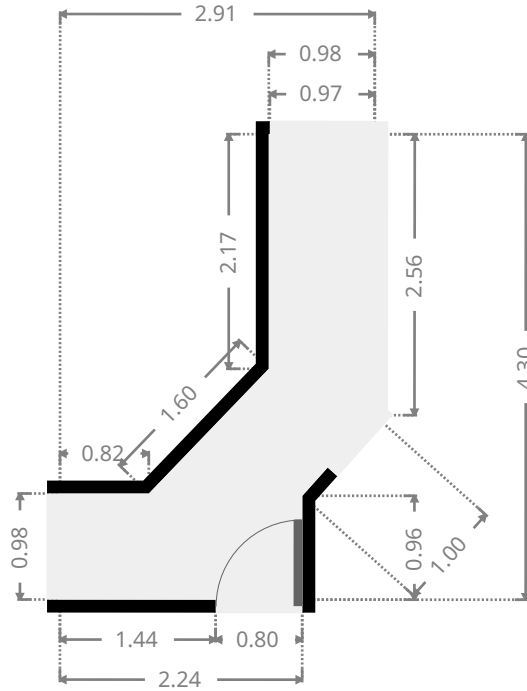

▼ **Living Room**  
Ground Floor

**WIDTH:** 4.30 m • **LENGTH:** 4.91 m  
**AREA:** 18.28 m<sup>2</sup> • **PERIMETER:** 17.24 m

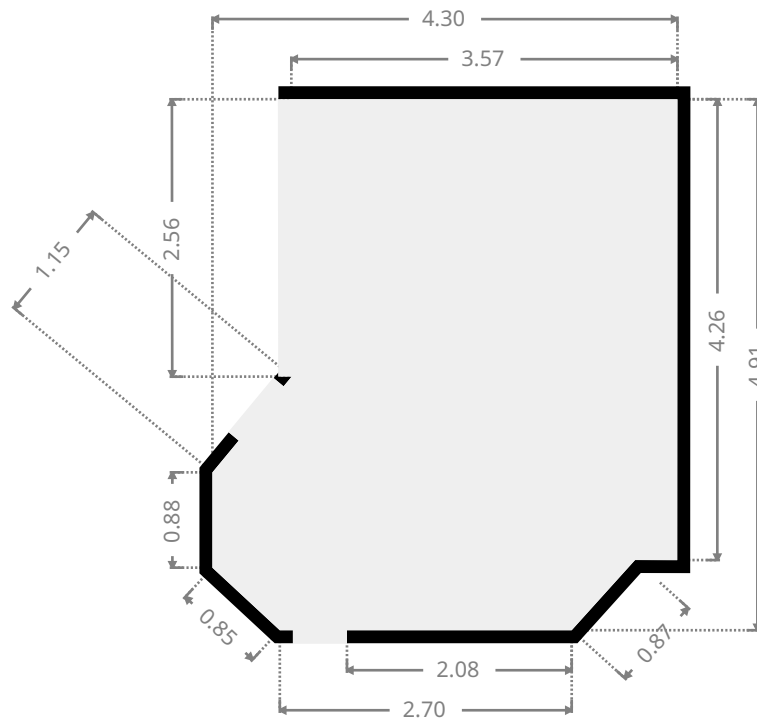
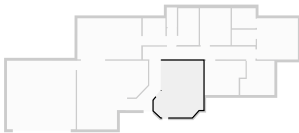

▼ **Hall**  
Ground Floor

**WIDTH:** 9.79 m • **LENGTH:** 1.12 m  
**AREA:** 10.92 m<sup>2</sup> • **PERIMETER:** 21.81 m

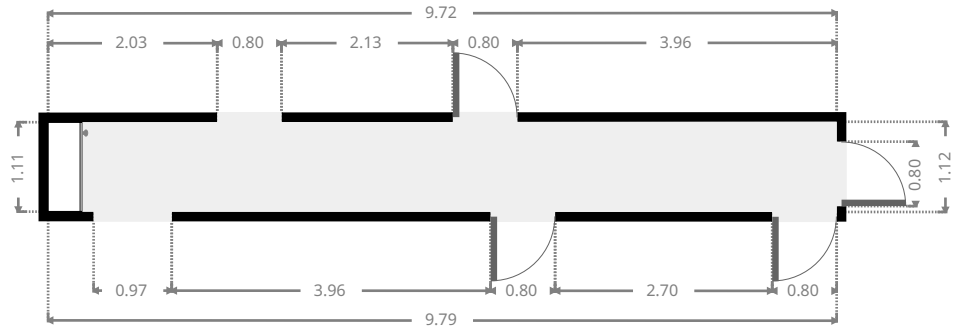
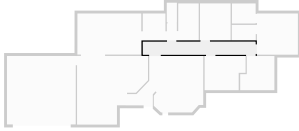

▼ **Hall**  
Ground Floor

**WIDTH:** 0.87 m • **LENGTH:** 1.50 m  
**AREA:** 1.31 m<sup>2</sup> • **PERIMETER:** 4.74 m

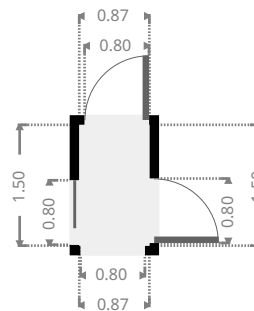

▼ **Laundry Room**  
Ground Floor

WIDTH: 1.97 m • LENGTH: 2.35 m  
AREA: 4.63 m<sup>2</sup> • PERIMETER: 8.64 m

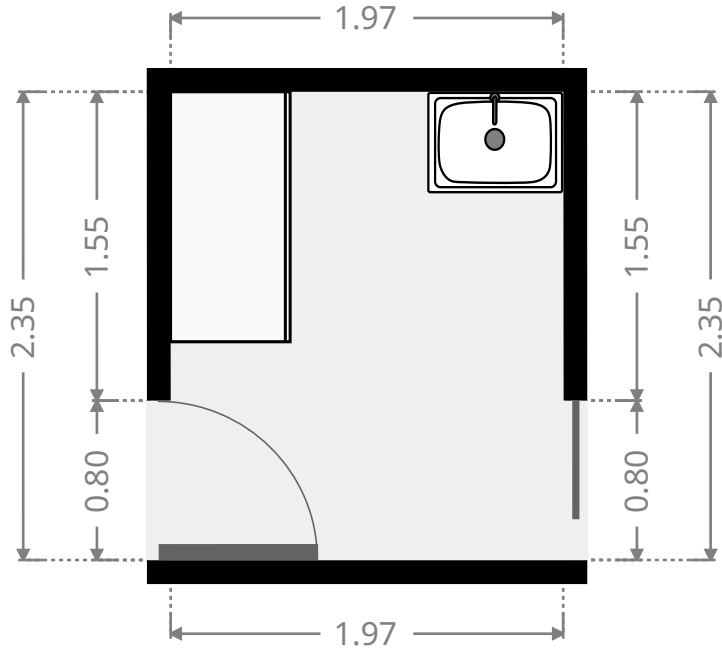
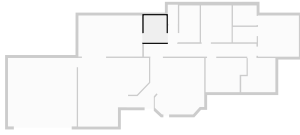

▼ **Toilet**  
Ground Floor

WIDTH: 0.88 m • LENGTH: 1.70 m  
AREA: 1.50 m<sup>2</sup> • PERIMETER: 5.16 m

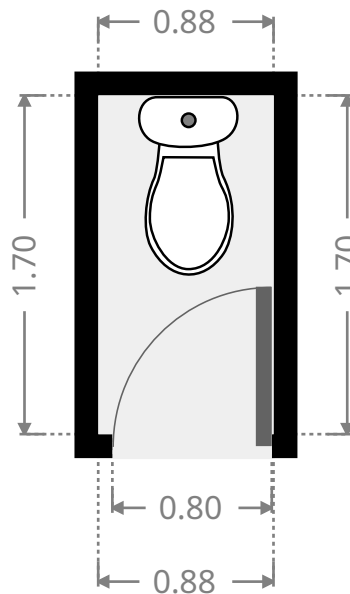
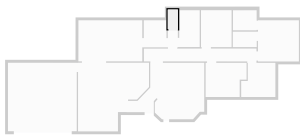

▼ **Bathroom**  
Ground Floor

WIDTH: 1.78 m • LENGTH: 3.20 m  
AREA: 5.70 m<sup>2</sup> • PERIMETER: 9.96 m

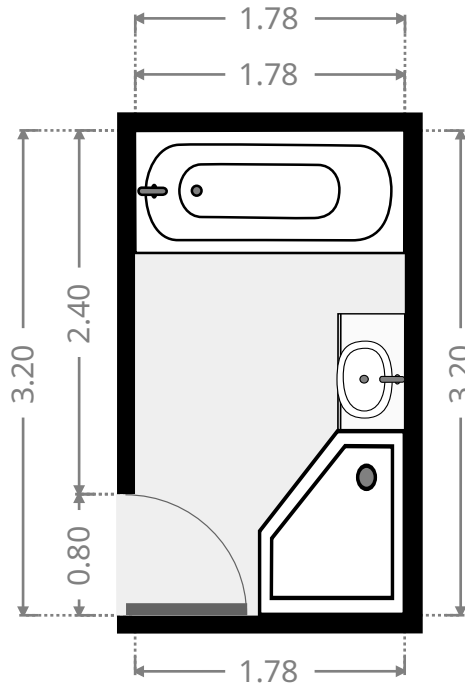
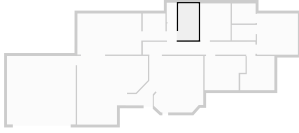

▼ **Bedroom**  
Ground Floor

WIDTH: 3.56 m • LENGTH: 2.97 m  
AREA: 9.67 m<sup>2</sup> • PERIMETER: 13.06 m

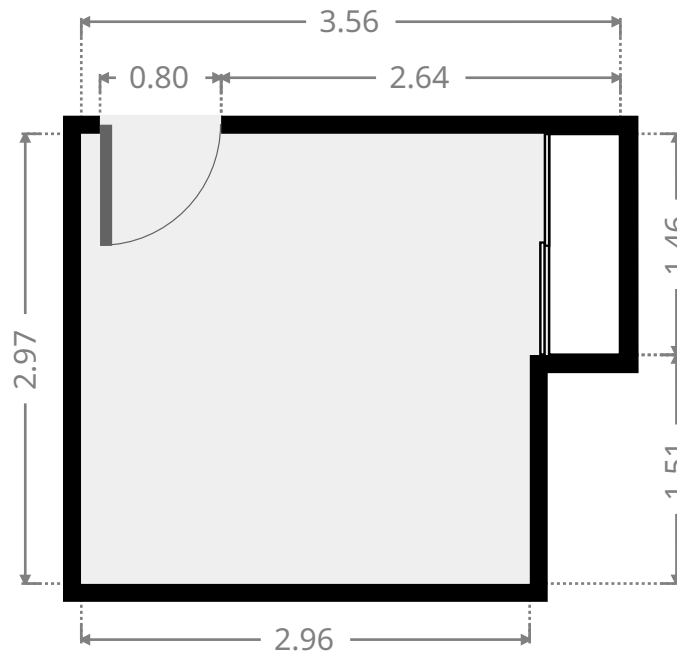
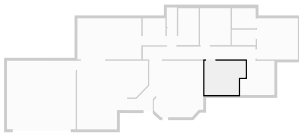

▼ **Bedroom**  
Ground Floor

WIDTH: 2.66 m • LENGTH: 3.21 m  
AREA: 8.54 m<sup>2</sup> • PERIMETER: 11.74 m

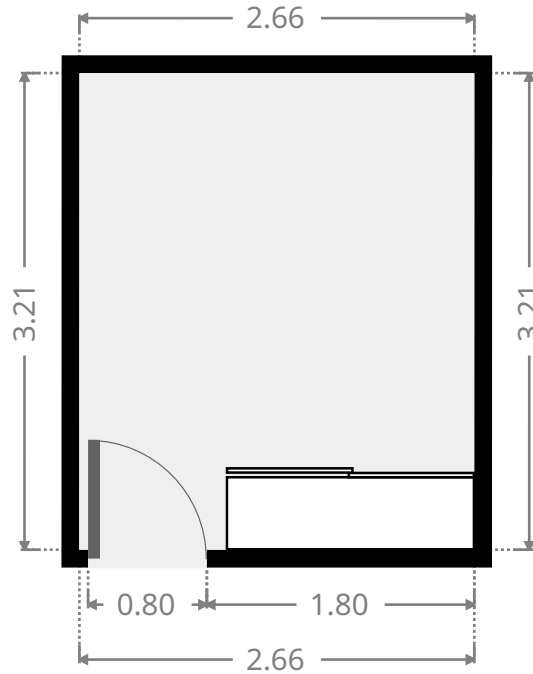
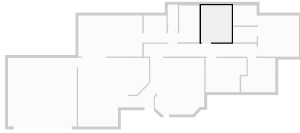

▼ **Bedroom**  
Ground Floor

WIDTH: 2.97 m • LENGTH: 2.97 m  
AREA: 7.92 m<sup>2</sup> • PERIMETER: 11.88 m

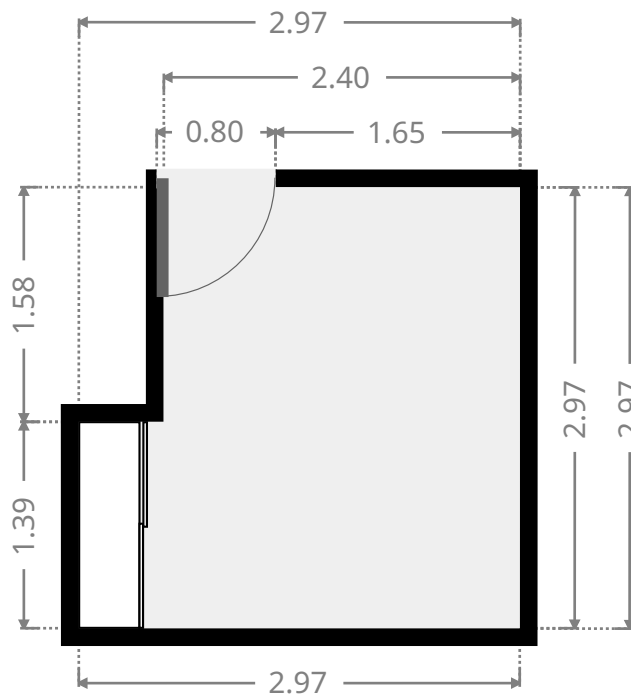

▼ **Master Bedroom**  
Ground Floor

WIDTH: 3.56 m • LENGTH: 3.58 m  
AREA: 12.74 m<sup>2</sup> • PERIMETER: 14.28 m

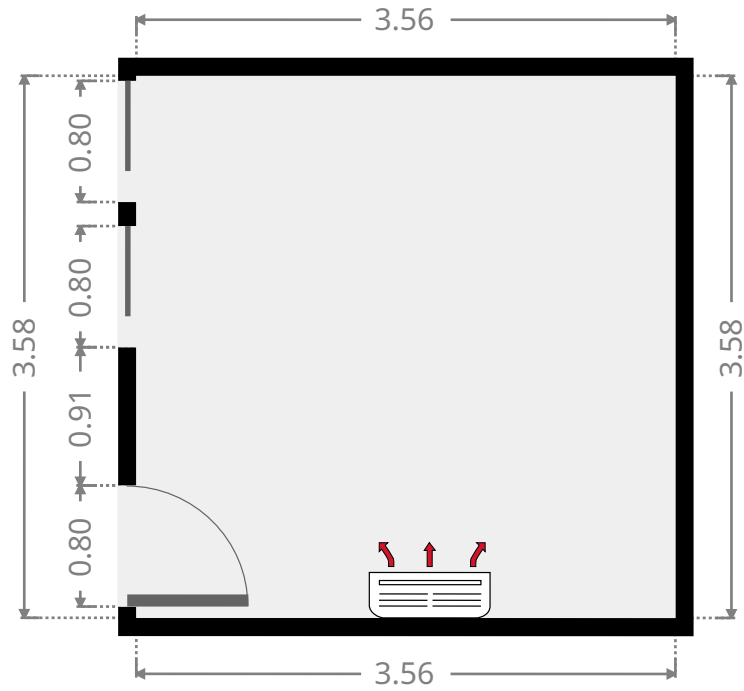

▼ **Closet**  
Ground Floor

WIDTH: 2.08 m • LENGTH: 1.34 m  
AREA: 2.79 m<sup>2</sup> • PERIMETER: 6.84 m

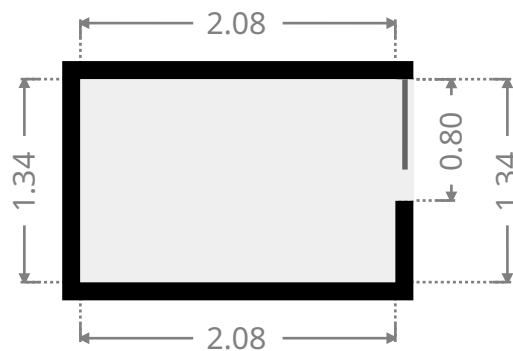
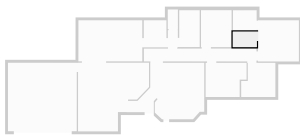



▼ **Bathroom**  
Ground Floor

WIDTH: 2.06 m • LENGTH: 1.74 m  
AREA: 3.58 m<sup>2</sup> • PERIMETER: 7.60 m

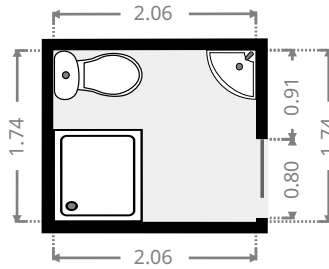

▼ **Kitchen**  
Ground Floor

WIDTH: 6.17 m • LENGTH: 5.97 m  
AREA: 29.61 m<sup>2</sup> • PERIMETER: 23.66 m

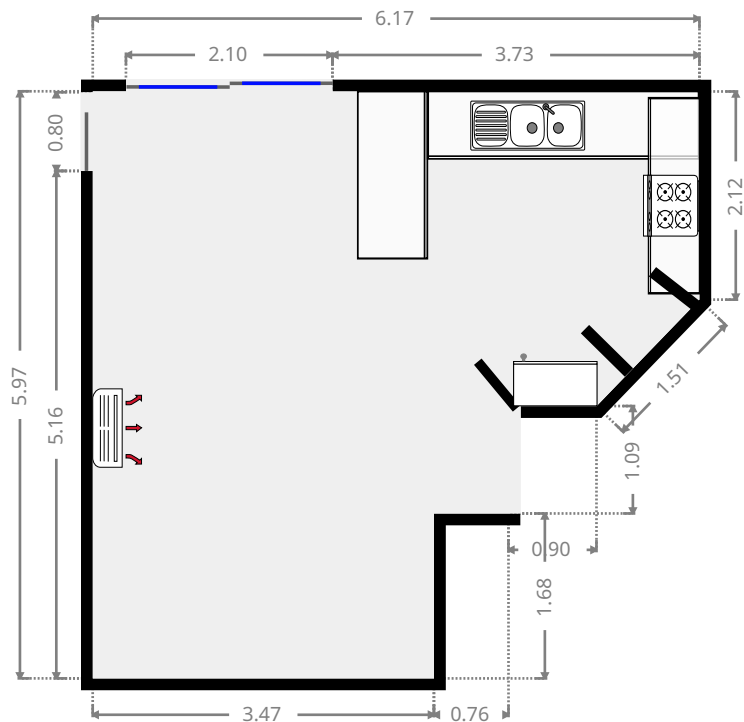
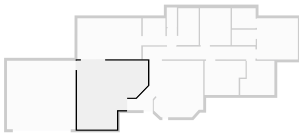

▼ **Garage**  
Ground Floor

WIDTH: 5.98 m • LENGTH: 5.95 m  
AREA: 35.59 m<sup>2</sup> • PERIMETER: 23.86 m

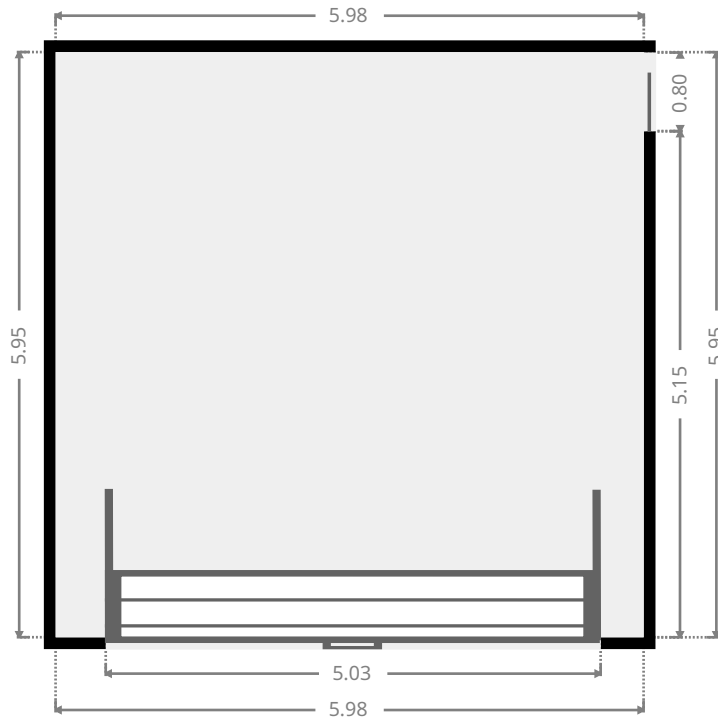

▼ **Other**  
Ground Floor

WIDTH: 5.56 m • LENGTH: 3.57 m  
AREA: 19.82 m<sup>2</sup> • PERIMETER: 18.25 m

