

6 Wittenberg Way

Created on
2021-02-16

Floors
1



▼ Ground Floor

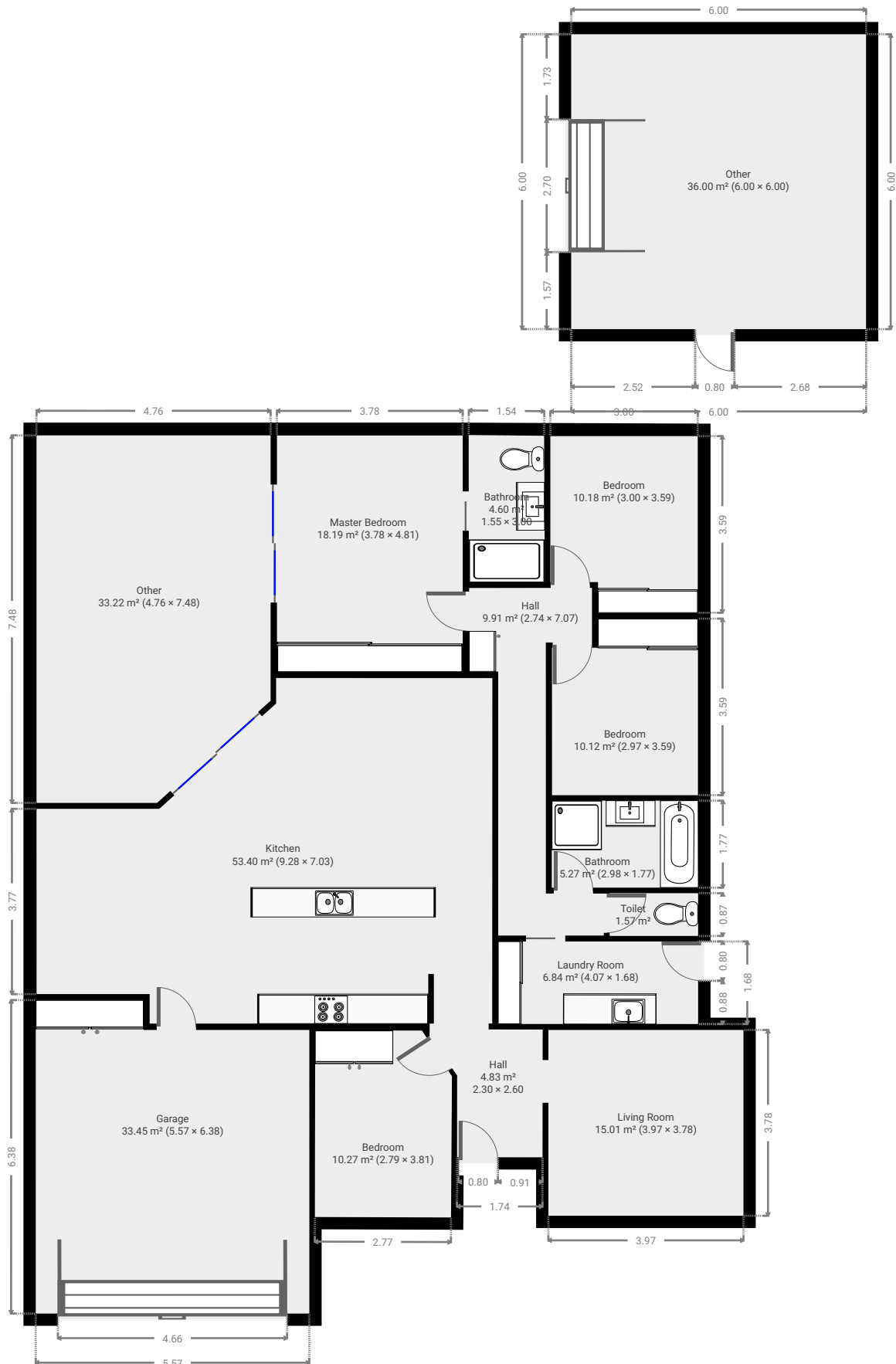

▼ **Hall**
Ground Floor

WIDTH: 2.30 m • LENGTH: 2.60 m
AREA: 4.83 m² • PERIMETER: 9.42 m

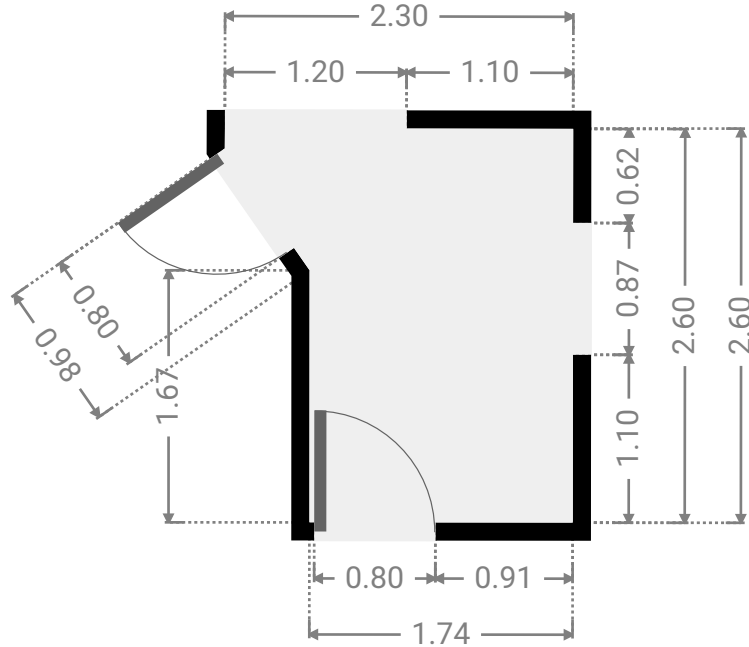

▼ **Living Room**
Ground Floor

WIDTH: 3.97 m • LENGTH: 3.78 m
AREA: 15.01 m² • PERIMETER: 15.50 m

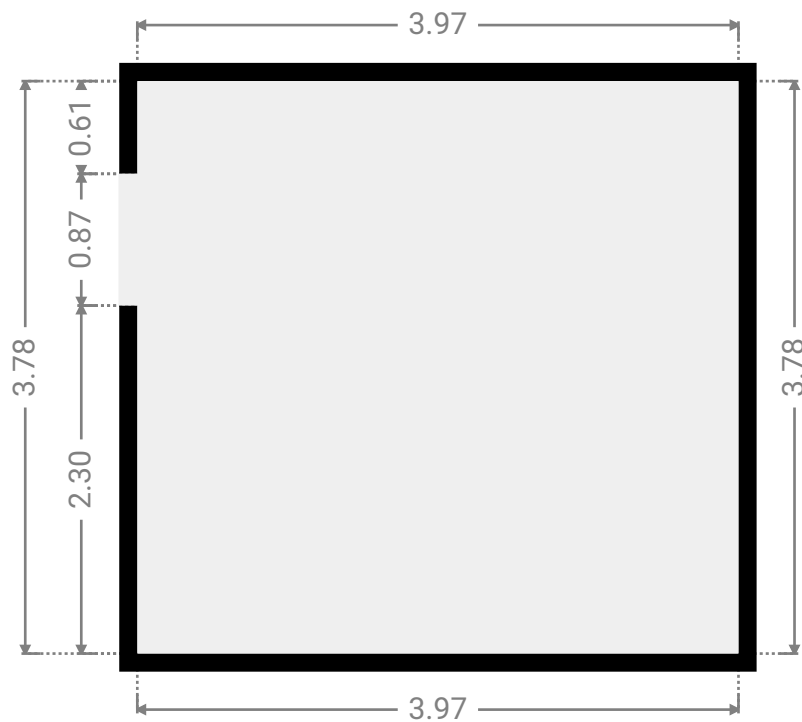
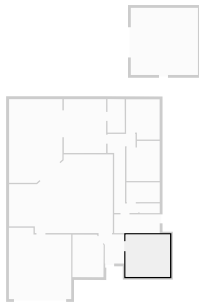

▼ **Bedroom**
Ground Floor

WIDTH: 2.79 m • LENGTH: 3.81 m
AREA: 10.27 m² • PERIMETER: 12.72 m

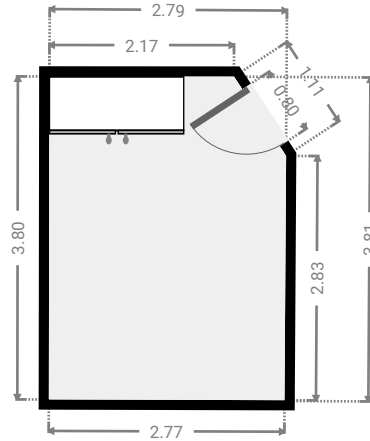

▼ **Kitchen**
Ground Floor

WIDTH: 9.28 m • LENGTH: 7.03 m
AREA: 53.40 m² • PERIMETER: 31.29 m

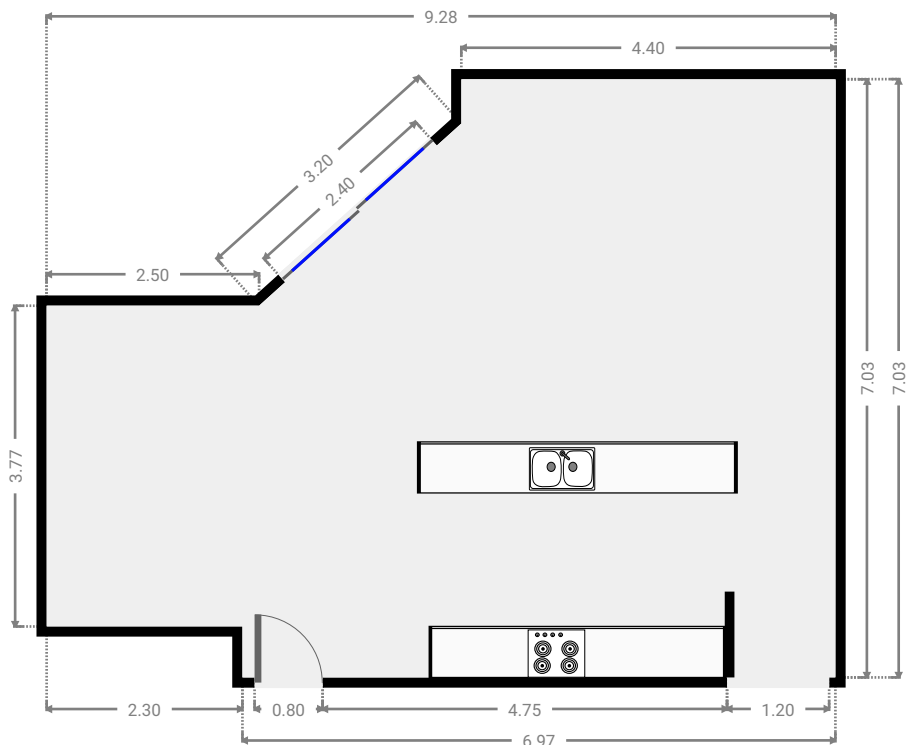
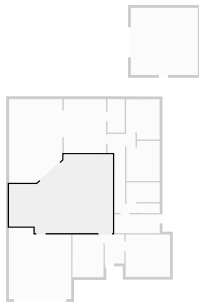

▼ **Garage**
Ground Floor

WIDTH: 5.57 m • LENGTH: 6.38 m
AREA: 33.45 m² • PERIMETER: 23.89 m

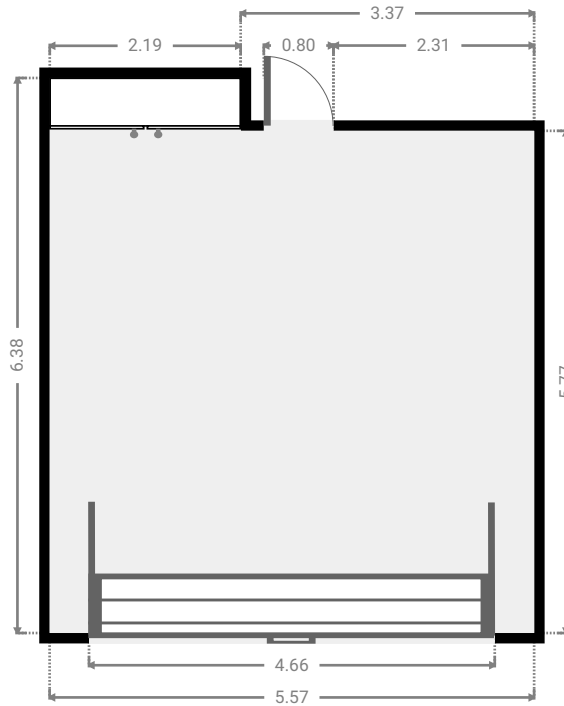

▼ **Other**
Ground Floor

WIDTH: 4.76 m • LENGTH: 7.48 m
AREA: 33.22 m² • PERIMETER: 23.20 m

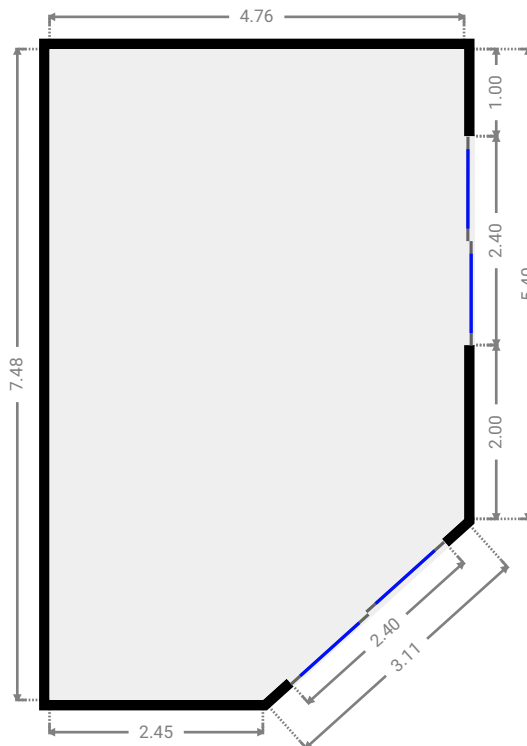
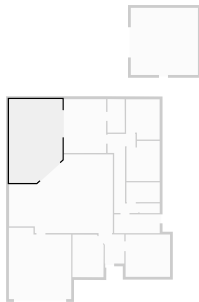

▼ Laundry Room
Ground Floor

WIDTH: 4.07 m • LENGTH: 1.68 m
AREA: 6.84 m² • PERIMETER: 11.50 m

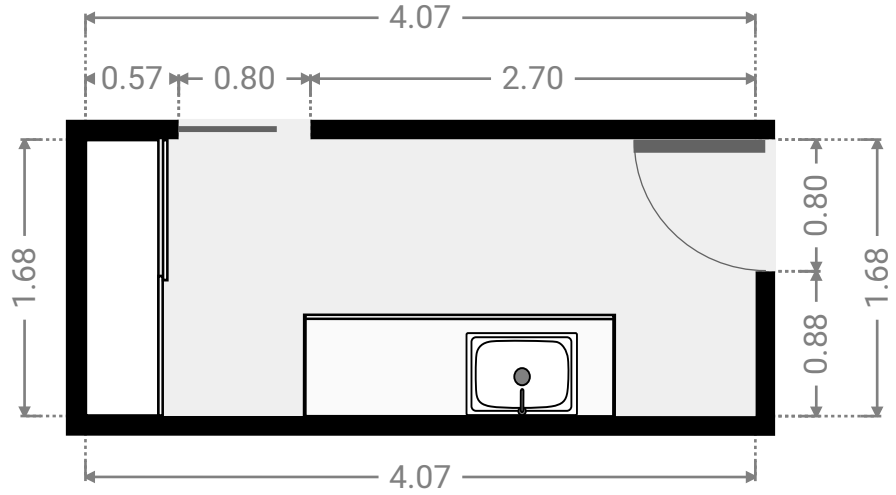
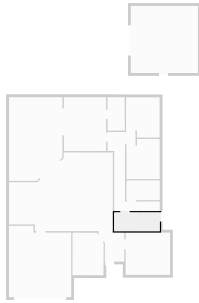

▼ Toilet
Ground Floor

WIDTH: 1.80 m • LENGTH: 0.87 m
AREA: 1.57 m² • PERIMETER: 5.34 m

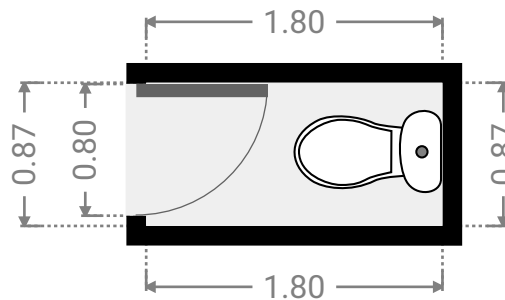
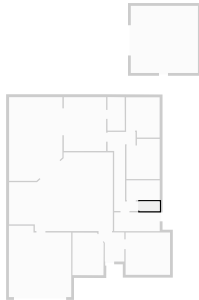

▼ **Bathroom**
Ground Floor

WIDTH: 2.98 m • LENGTH: 1.77 m
AREA: 5.27 m² • PERIMETER: 9.50 m

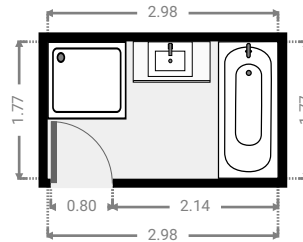
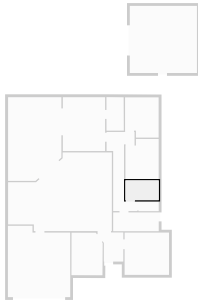

▼ **Hall**
Ground Floor

WIDTH: 2.74 m • LENGTH: 7.07 m
AREA: 9.91 m² • PERIMETER: 21.51 m

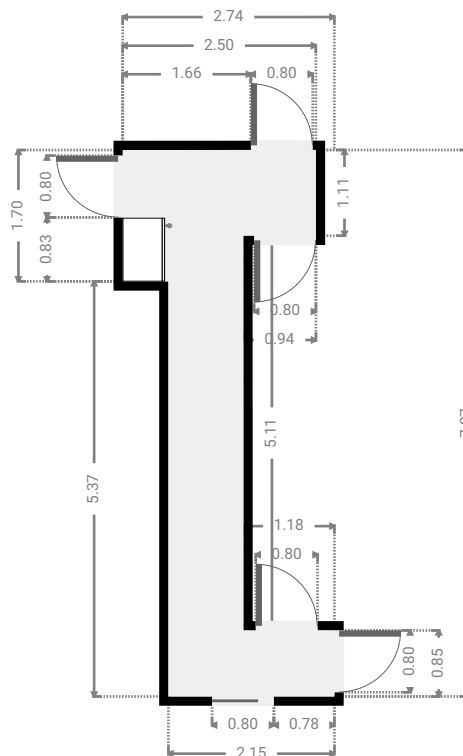
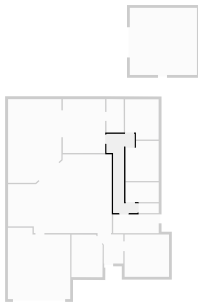

▼ **Bedroom**
Ground Floor

WIDTH: 2.97 m • LENGTH: 3.59 m
AREA: 10.12 m² • PERIMETER: 13.12 m

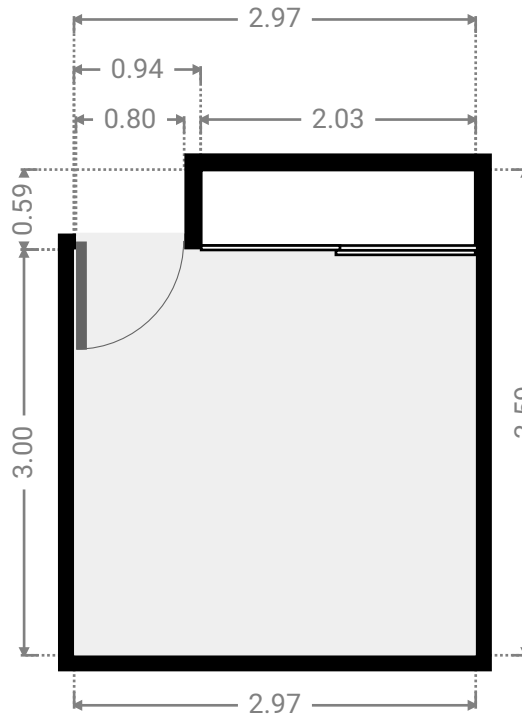
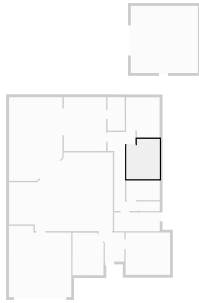

▼ **Bedroom**
Ground Floor

WIDTH: 3.00 m • LENGTH: 3.59 m
AREA: 10.18 m² • PERIMETER: 13.19 m

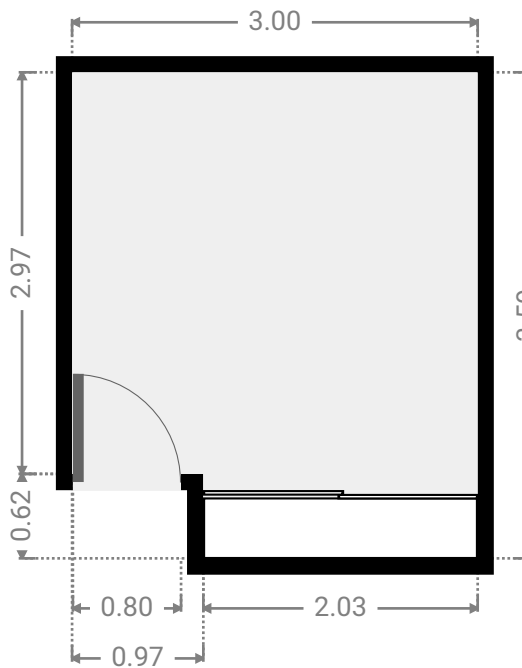
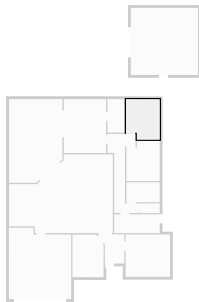

▼ **Master Bedroom**
Ground Floor

WIDTH: 3.78 m • LENGTH: 4.81 m
AREA: 18.19 m² • PERIMETER: 17.18 m

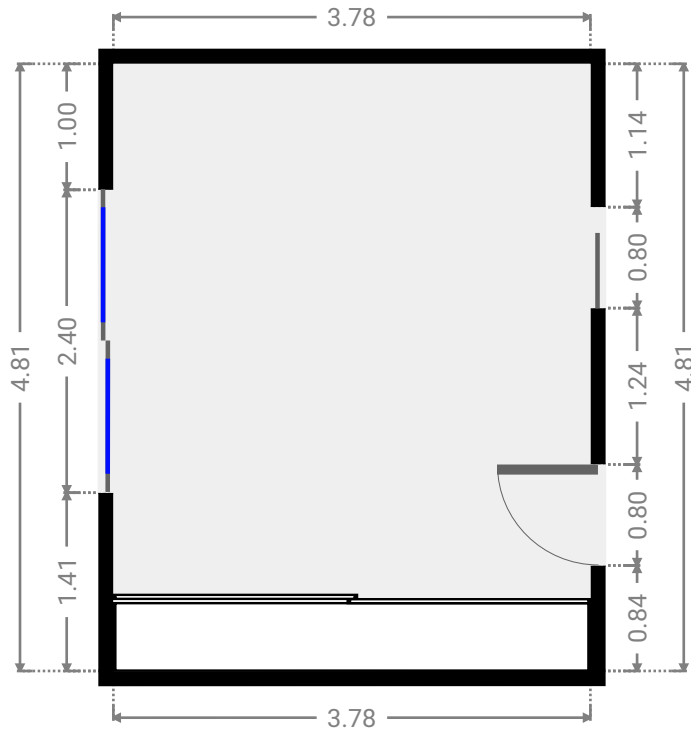
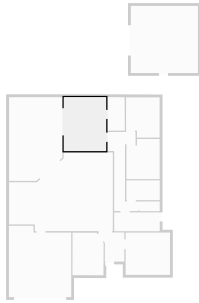

▼ **Bathroom**
Ground Floor

WIDTH: 1.55 m • LENGTH: 3.00 m
AREA: 4.60 m² • PERIMETER: 9.06 m

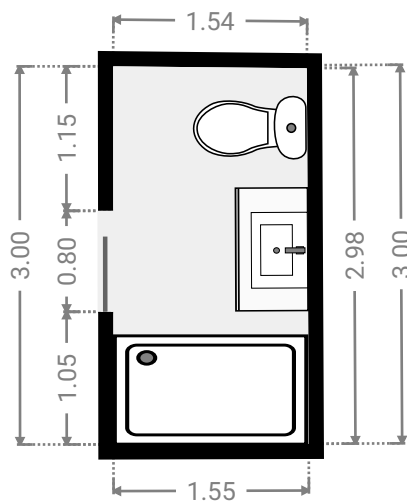
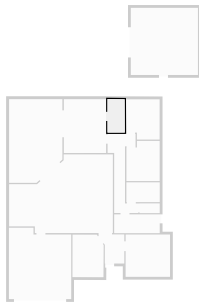

▼ Other
Ground Floor

WIDTH: 6.00 m • LENGTH: 6.00 m
AREA: 36.00 m² • PERIMETER: 24.00 m

