

# 6 Sunrise Crescent

**SUBMITTED BY**

Ray White Rockhampton Casey  
stockers@cqoz.com

---

**CREATED ON**

2022-07-21

---

**Floors**

2

---

## ▼ Ground Floor

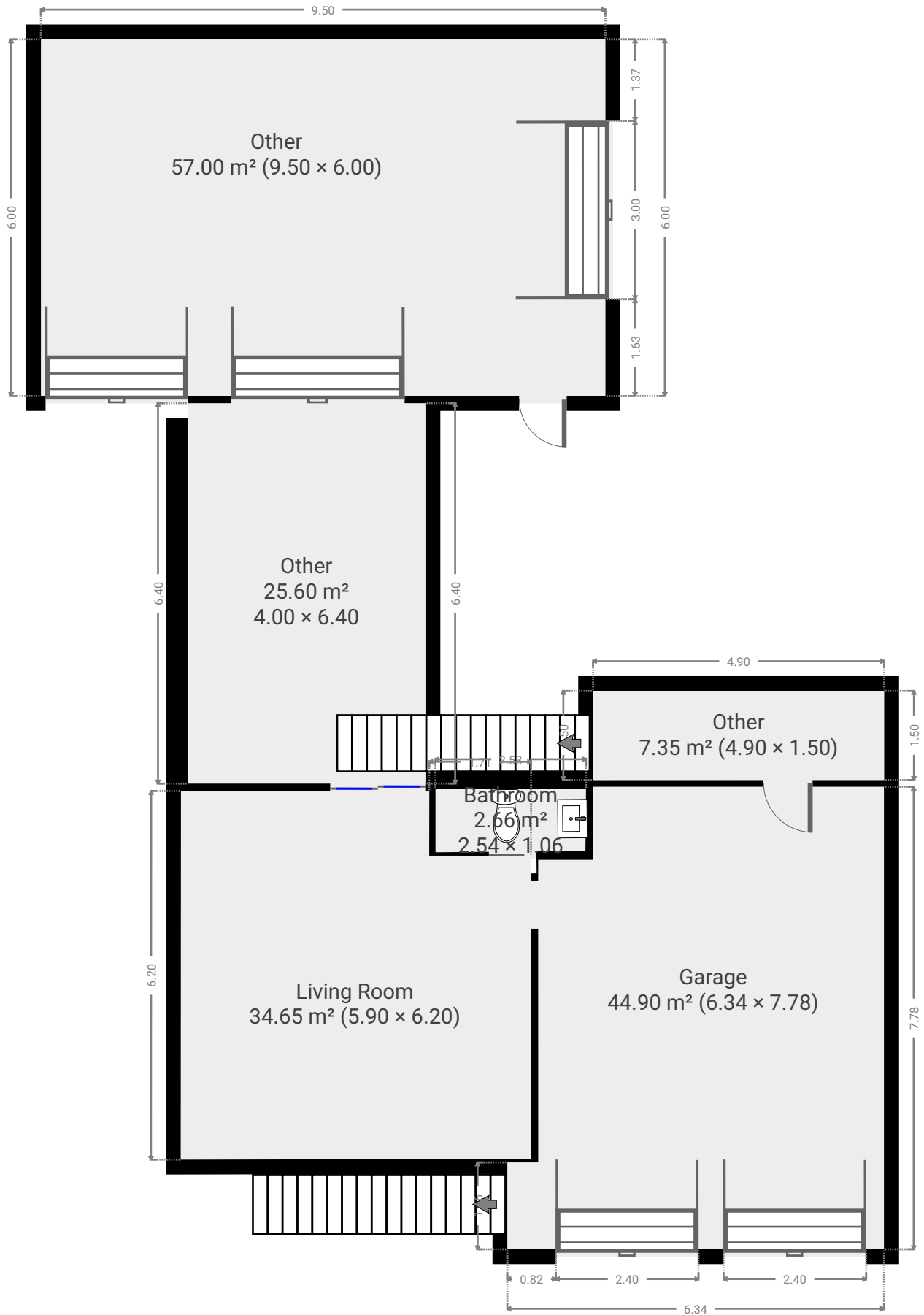

# 6 Sunrise Crescent

FLOORS: 2



## ▼ Bathroom Ground Floor

WIDTH: 2.54 m • LENGTH: 1.06 m  
AREA: 2.66 m<sup>2</sup> • PERIMETER: 7.16 m

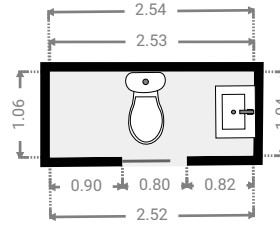
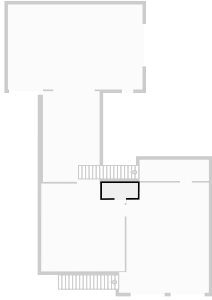

## ▼ Garage Ground Floor

WIDTH: 6.34 m • LENGTH: 7.78 m  
AREA: 44.90 m<sup>2</sup> • PERIMETER: 28.24 m

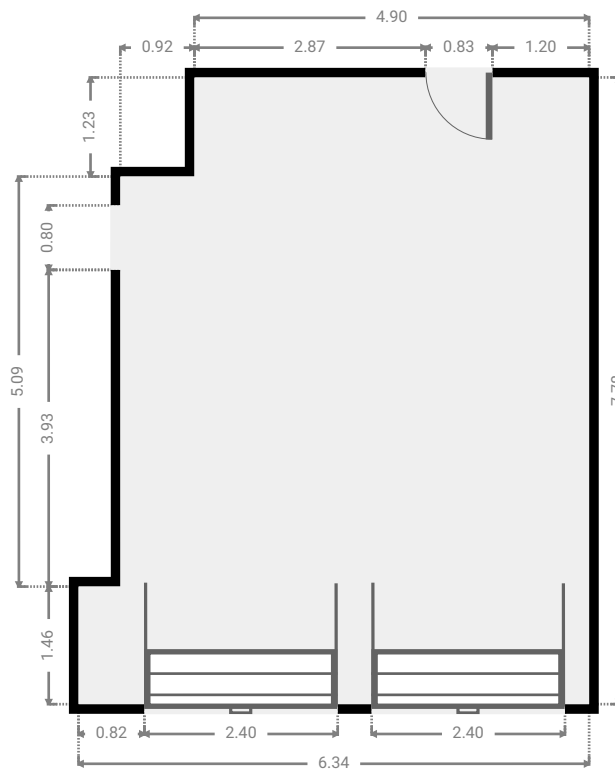
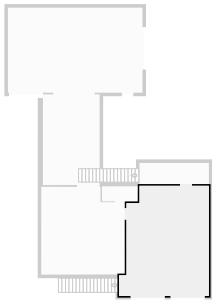

THIS FLOORPLAN IS PROVIDED WITHOUT WARRANTY OF ANY KIND. SENSOPIA DISCLAIMS ANY WARRANTY INCLUDING, WITHOUT LIMITATION, SATISFACTORY QUALITY OR ACCURACY OF DIMENSIONS.

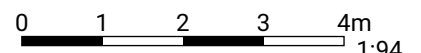

# 6 Sunrise Crescent

FLOORS: 2



## ▼ Living Room Ground Floor

WIDTH: 5.90 m • LENGTH: 6.20 m  
AREA: 34.65 m<sup>2</sup> • PERIMETER: 24.18 m

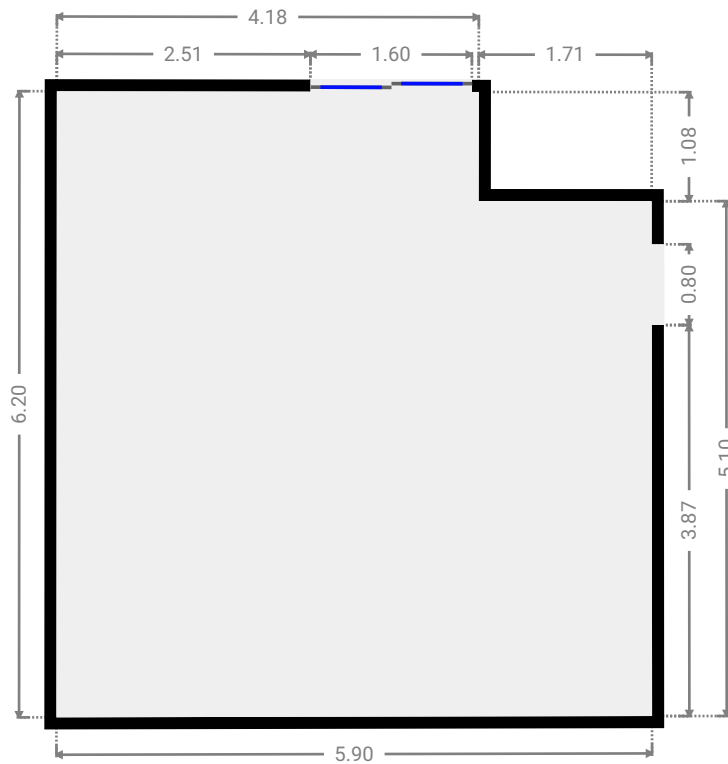
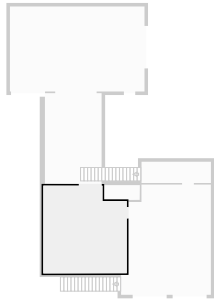

## ▼ Other Ground Floor

WIDTH: 4.90 m • LENGTH: 1.50 m  
AREA: 7.35 m<sup>2</sup> • PERIMETER: 12.80 m

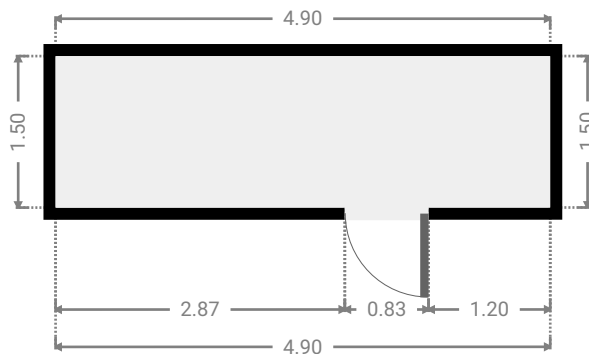
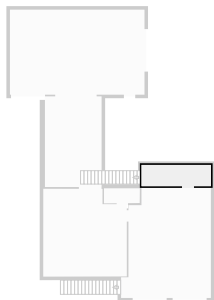

# 6 Sunrise Crescent

FLOORS: 2



## ▼ Other Ground Floor

WIDTH: 4.00 m • LENGTH: 6.40 m  
AREA: 25.60 m<sup>2</sup> • PERIMETER: 20.80 m

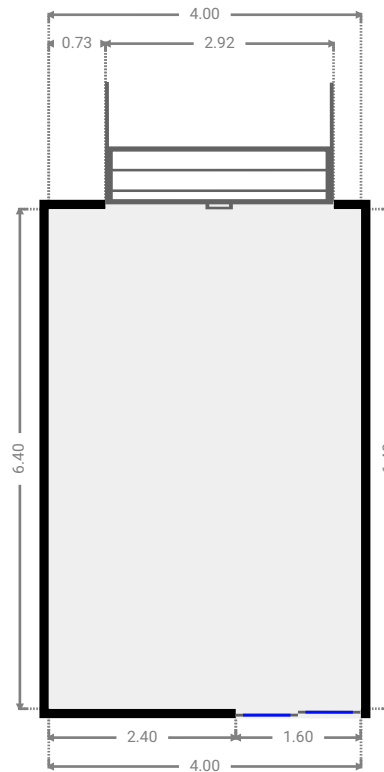
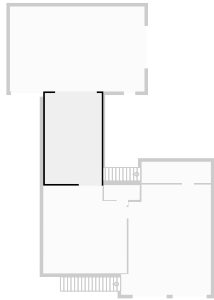

## ▼ Other Ground Floor

WIDTH: 9.50 m • LENGTH: 6.00 m  
AREA: 57.00 m<sup>2</sup> • PERIMETER: 31.00 m

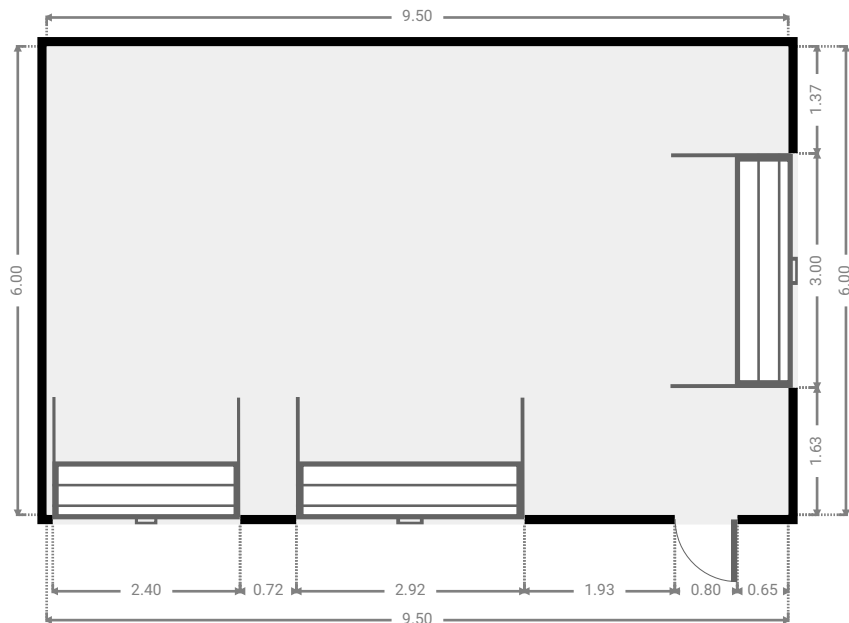
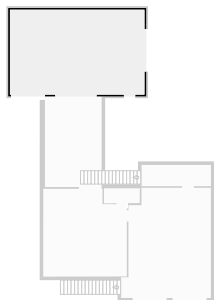

## ▼ 1st Floor

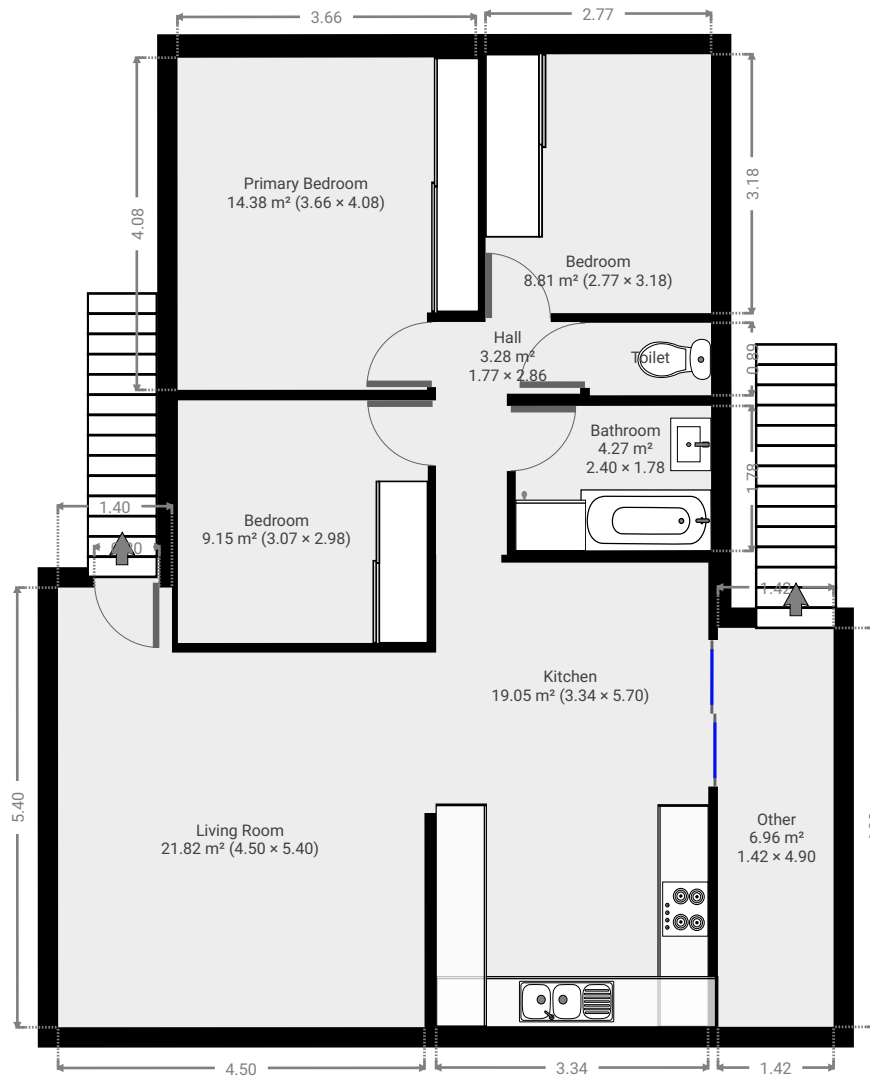

## ▼ Bathroom 1st Floor

WIDTH: 1.78 m • LENGTH: 2.40 m  
AREA: 4.27 m<sup>2</sup> • PERIMETER: 8.36 m

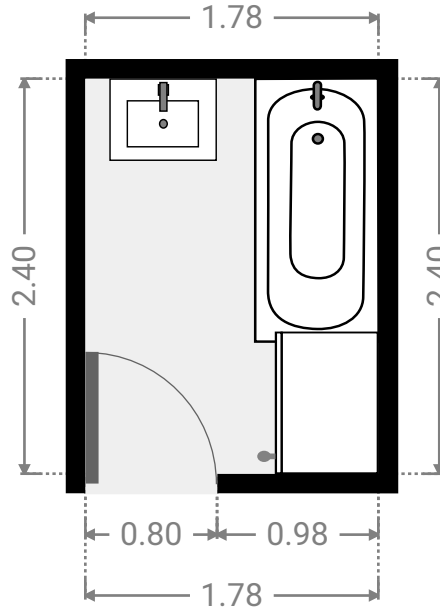
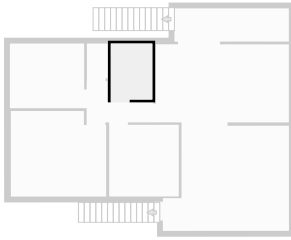

## ▼ Bedroom 1st Floor

WIDTH: 2.98 m • LENGTH: 3.07 m  
AREA: 9.15 m<sup>2</sup> • PERIMETER: 12.10 m

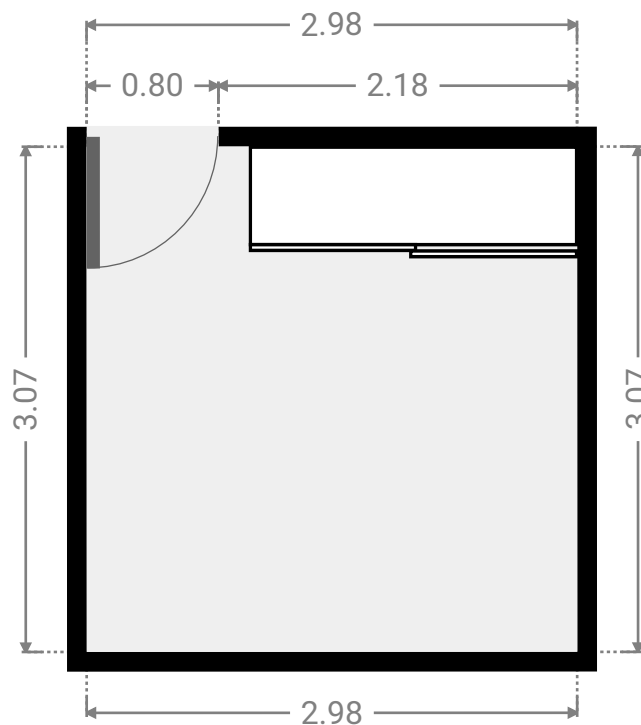
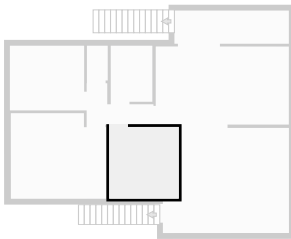

## ▼ Bedroom 1st Floor

WIDTH: 3.18 m • LENGTH: 2.77 m  
AREA: 8.81 m<sup>2</sup> • PERIMETER: 11.90 m

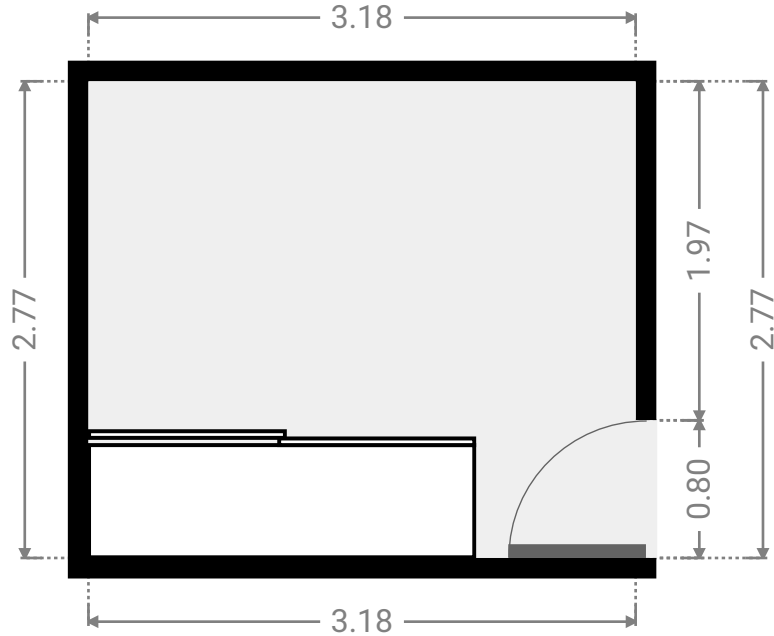
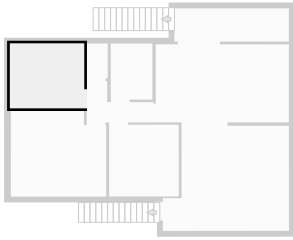

## ▼ Hall 1st Floor

WIDTH: 2.86 m • LENGTH: 1.77 m  
AREA: 3.28 m<sup>2</sup> • PERIMETER: 9.26 m

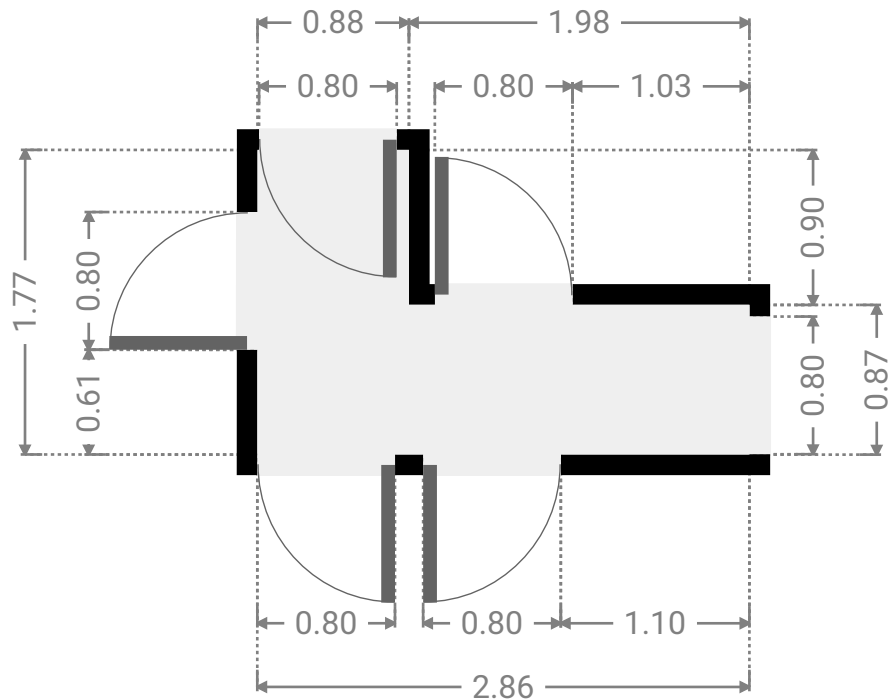
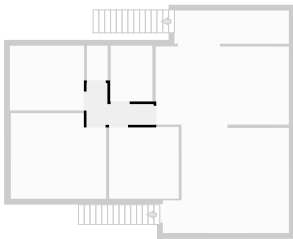



# 6 Sunrise Crescent

FLOORS: 2



## ▼ Kitchen 1st Floor

WIDTH: 5.70 m • LENGTH: 3.34 m  
AREA: 19.05 m<sup>2</sup> • PERIMETER: 18.08 m

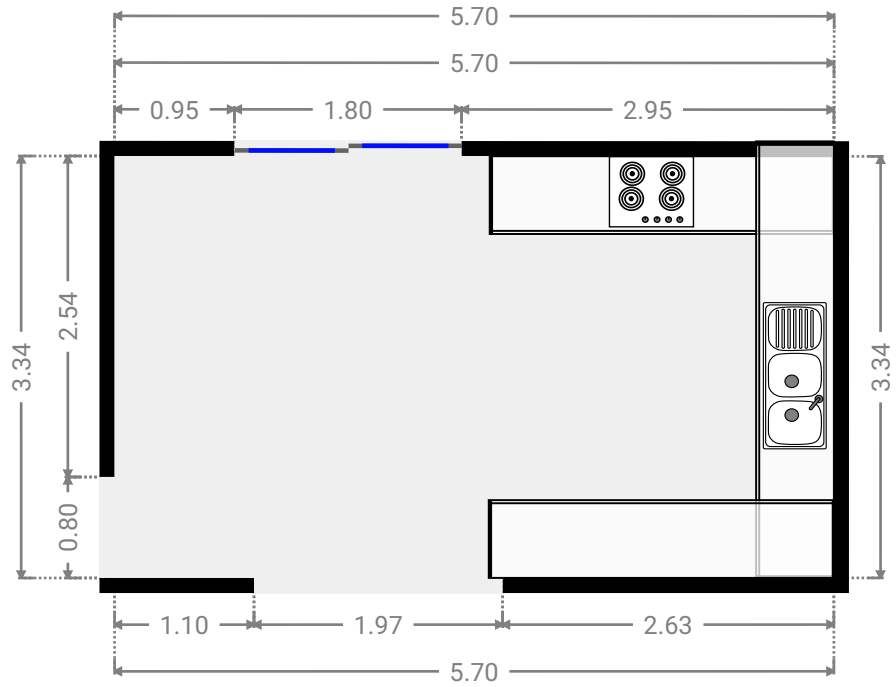
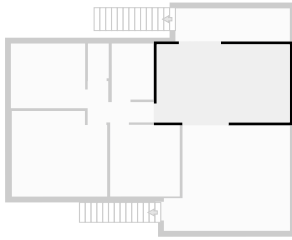

## ▼ Living Room 1st Floor

WIDTH: 5.40 m • LENGTH: 4.50 m  
AREA: 21.82 m<sup>2</sup> • PERIMETER: 19.80 m

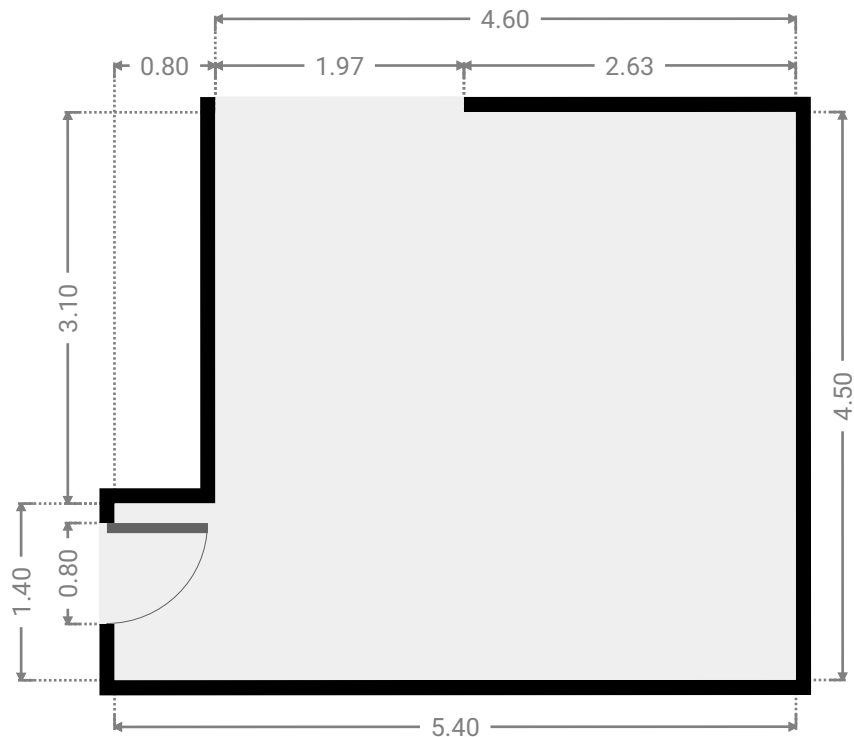
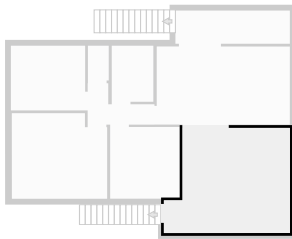

# 6 Sunrise Crescent

FLOORS: 2



## ▼ Other 1st Floor

WIDTH: 4.90 m • LENGTH: 1.42 m  
AREA: 6.96 m<sup>2</sup> • PERIMETER: 12.64 m

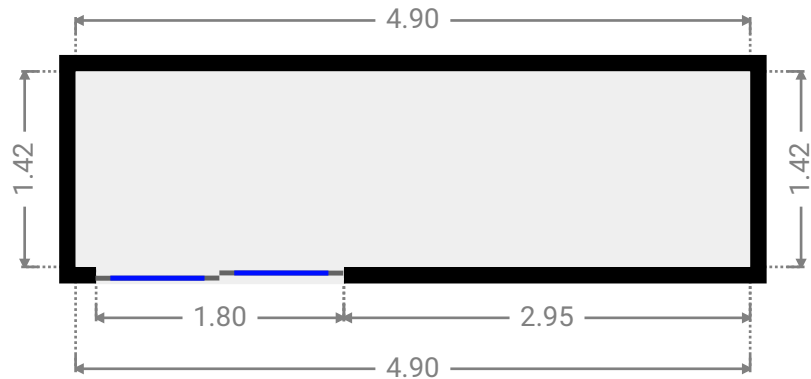
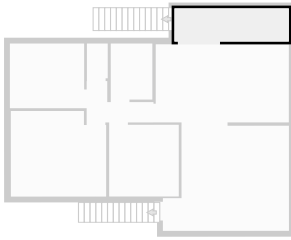

## ▼ Primary Bedroom 1st Floor

WIDTH: 4.08 m • LENGTH: 3.66 m  
AREA: 14.38 m<sup>2</sup> • PERIMETER: 15.49 m

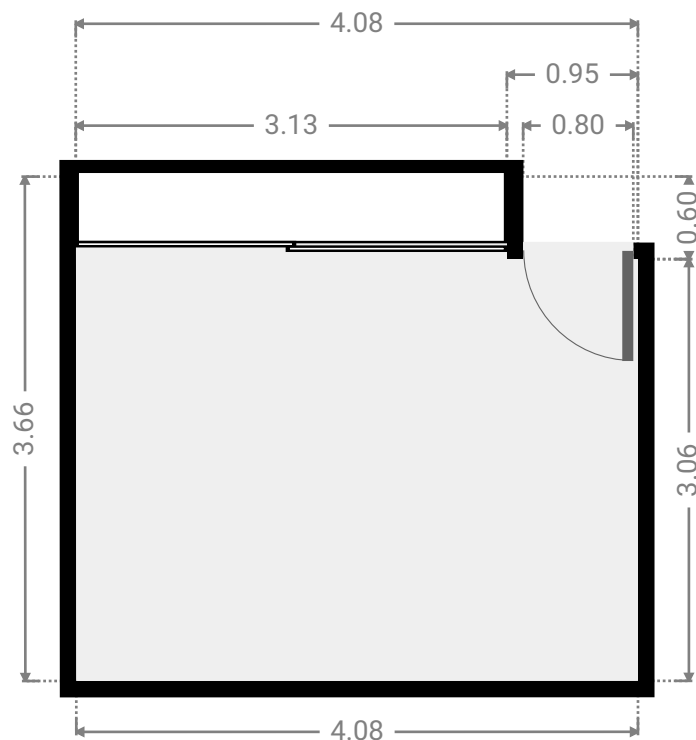
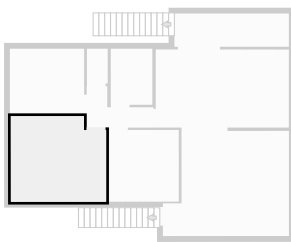

## ▼ Toilet 1st Floor

WIDTH: 0.89 m • LENGTH: 1.49 m  
AREA: 1.33 m<sup>2</sup> • PERIMETER: 4.76 m

