

Ground Floor

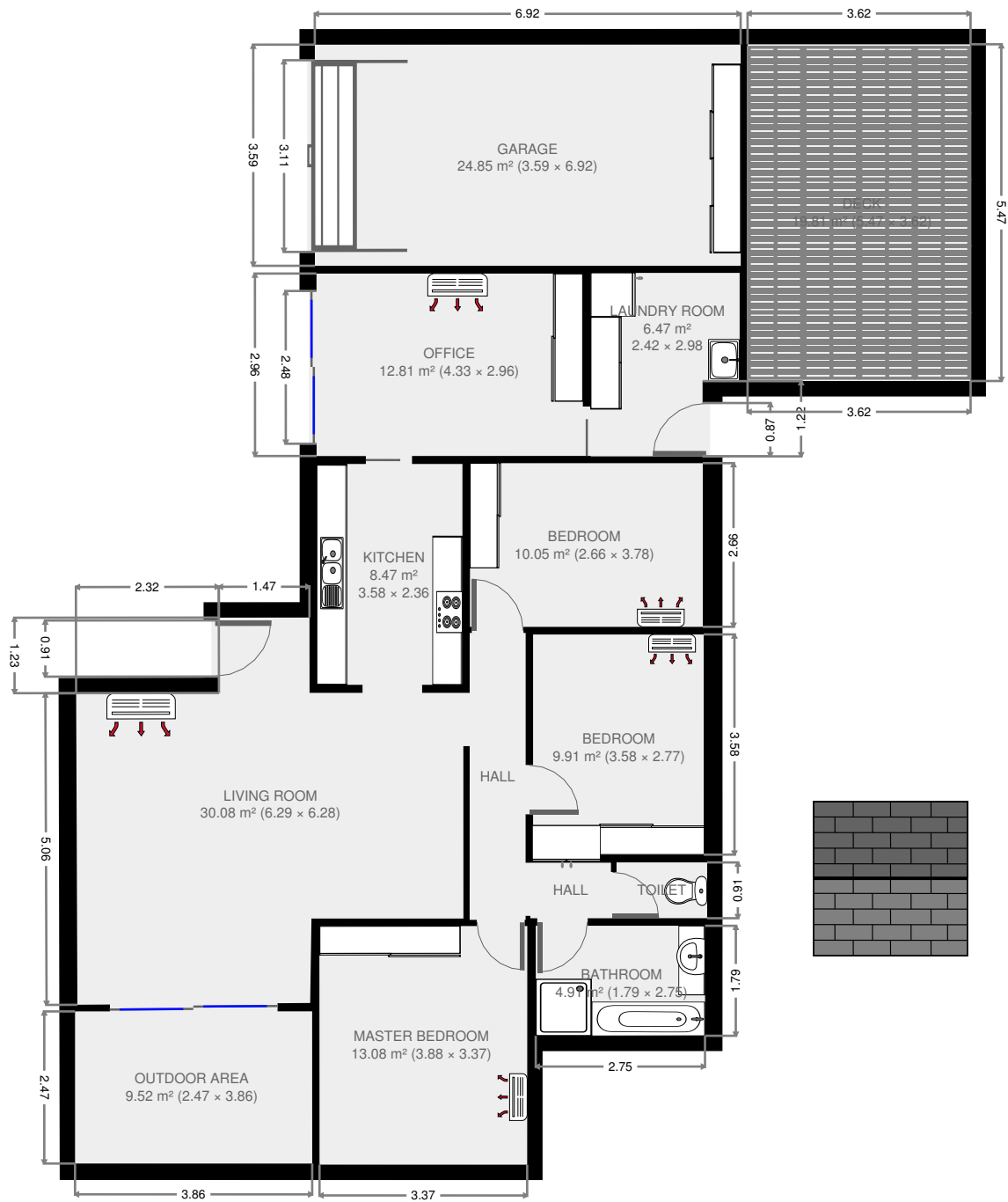

THIS FLOORPLAN IS PROVIDED WITHOUT WARRANTY OF ANY KIND. SENSOPIA DISCLAIMS ANY WARRANTY INCLUDING, WITHOUT LIMITATION, SATISFACTORY QUALITY OR ACCURACY OF DIMENSIONS.

6 Stawell Court

Living Room

Width: 6.28 m
 Length: 6.29 m
 Area: 30.08 m²
 Perimeter: 25.09 m
 Ceiling Height: 2.17 m

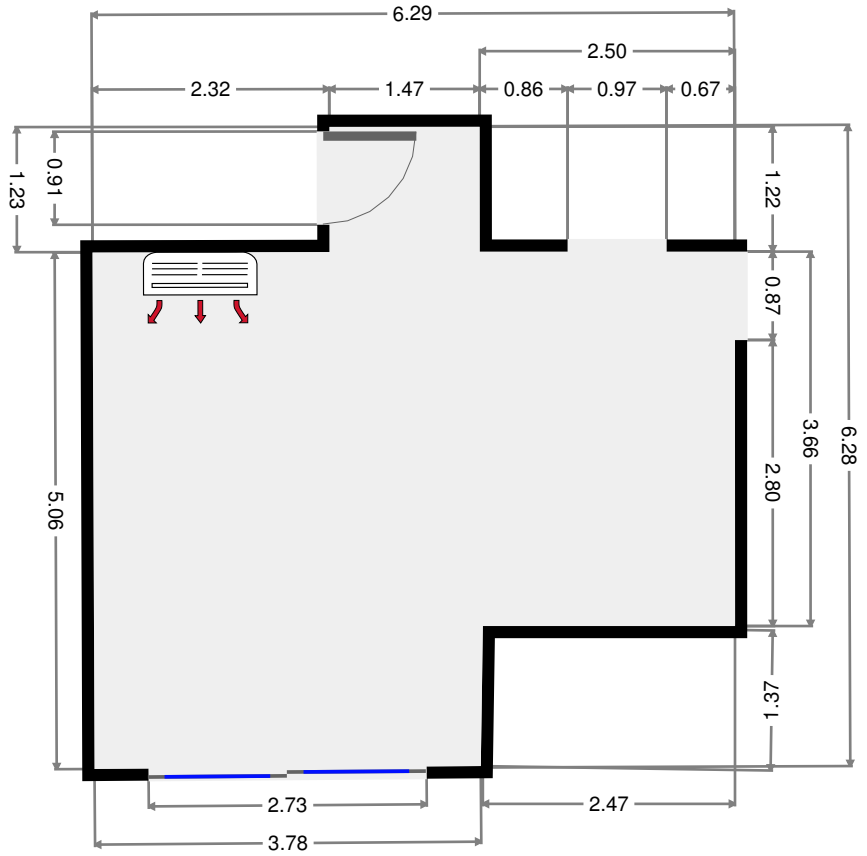
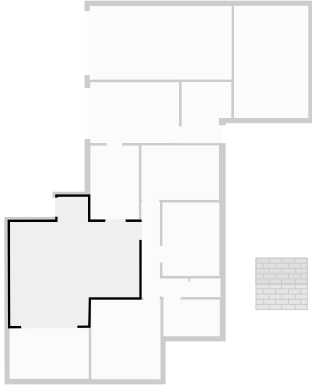

Kitchen

Width: 2.36 m
 Length: 3.58 m
 Area: 8.47 m²
 Perimeter: 11.90 m

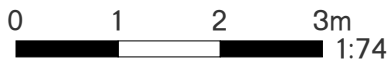
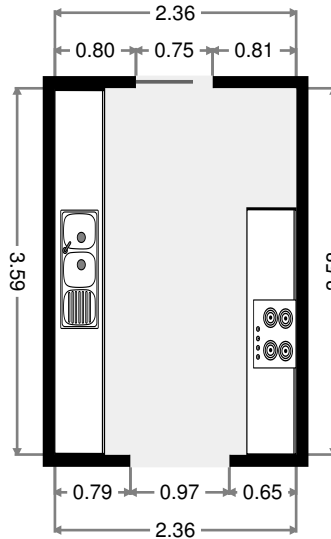
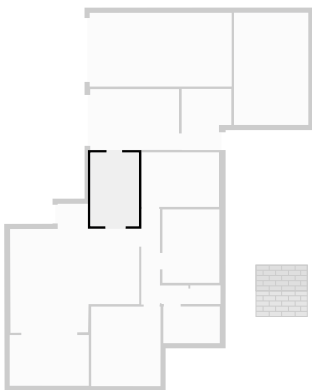

THIS FLOORPLAN IS PROVIDED WITHOUT WARRANTY OF ANY KIND. SENSOPIA DISCLAIMS ANY WARRANTY INCLUDING, WITHOUT LIMITATION, SATISFACTORY QUALITY OR ACCURACY OF DIMENSIONS.

Office

Width: 2.96 m
 Length: 4.33 m
 Area: 12.81 m²
 Perimeter: 14.58 m

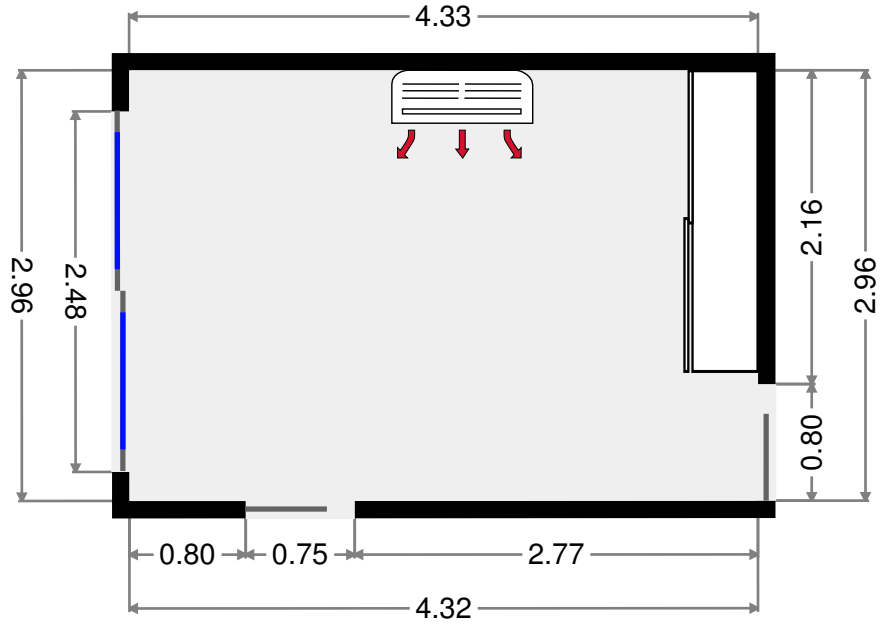
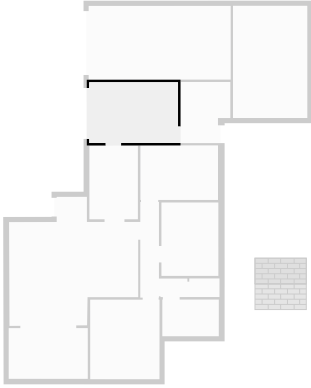

Laundry Room

Width: 2.42 m
 Length: 2.98 m
 Area: 6.47 m²
 Perimeter: 10.80 m
 Ceiling Height: 2.17 m

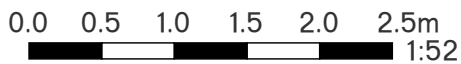
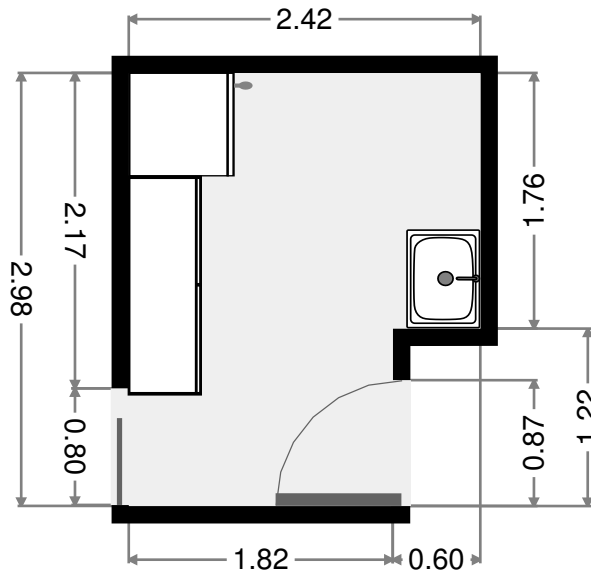
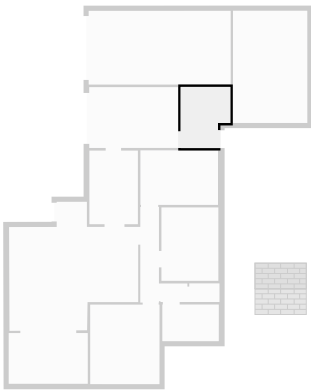

THIS FLOORPLAN IS PROVIDED WITHOUT WARRANTY OF ANY KIND. SENSOPIA DISCLAIMS ANY WARRANTY INCLUDING, WITHOUT LIMITATION, SATISFACTORY QUALITY OR ACCURACY OF DIMENSIONS.

Deck

Width: 3.62 m
 Length: 5.47 m
 Area: 19.81 m²
 Perimeter: 18.18 m

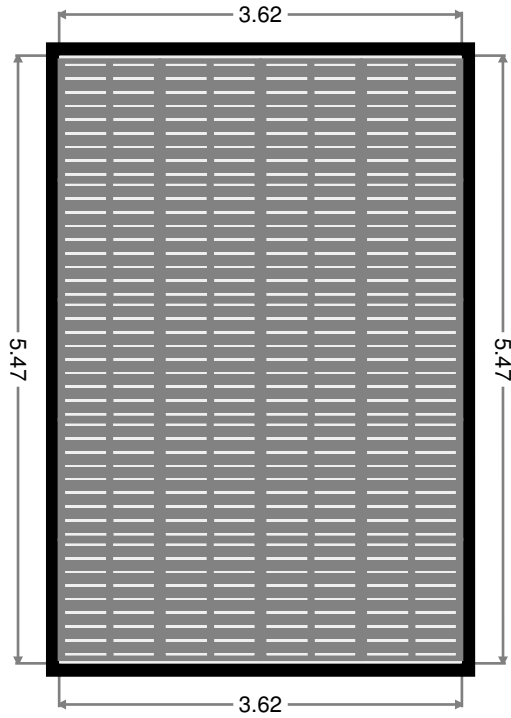
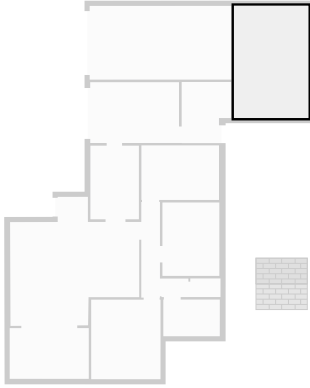

Hall

Width: 0.92 m
 Length: 4.66 m
 Area: 4.24 m²
 Perimeter: 11.14 m

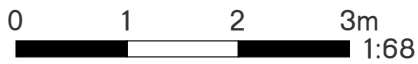
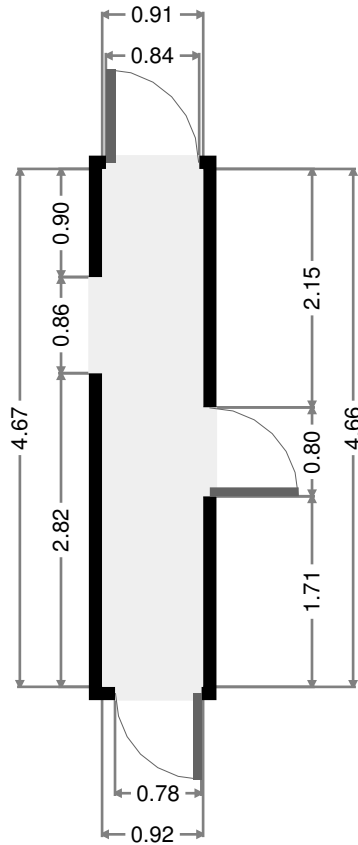

THIS FLOORPLAN IS PROVIDED WITHOUT WARRANTY OF ANY KIND. SENSOPIA DISCLAIMS ANY WARRANTY INCLUDING, WITHOUT LIMITATION, SATISFACTORY QUALITY OR ACCURACY OF DIMENSIONS.

Bedroom

Width: 2.66 m
 Length: 3.78 m
 Area: 10.05 m²
 Perimeter: 12.88 m

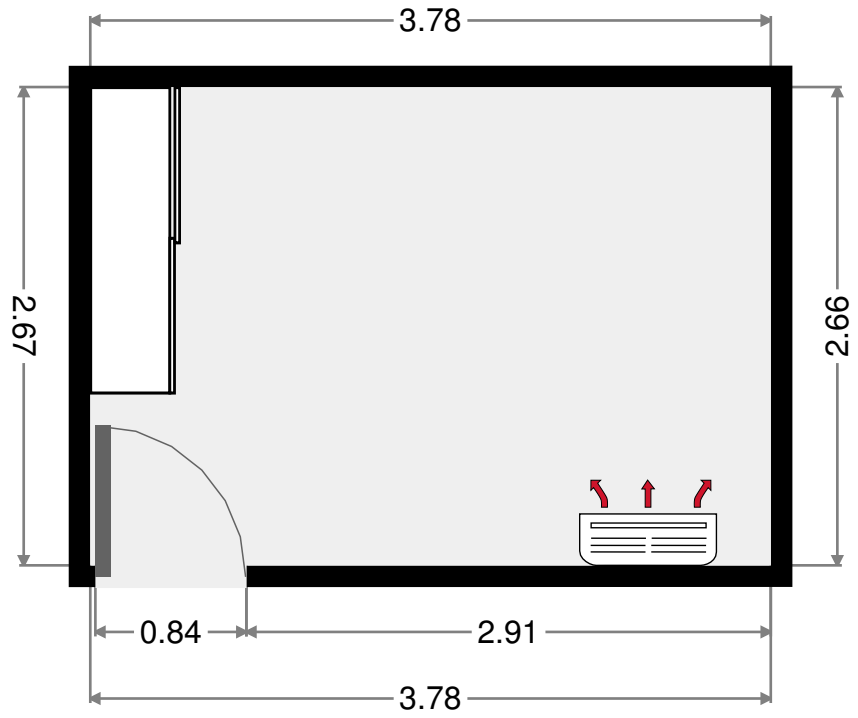
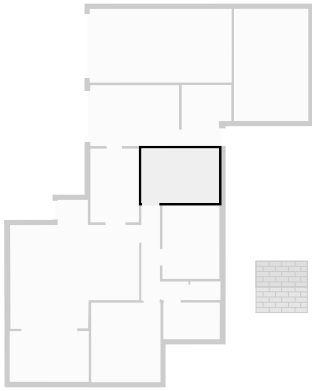

Bedroom

Width: 2.77 m
 Length: 3.58 m
 Area: 9.91 m²
 Perimeter: 12.70 m

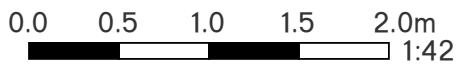
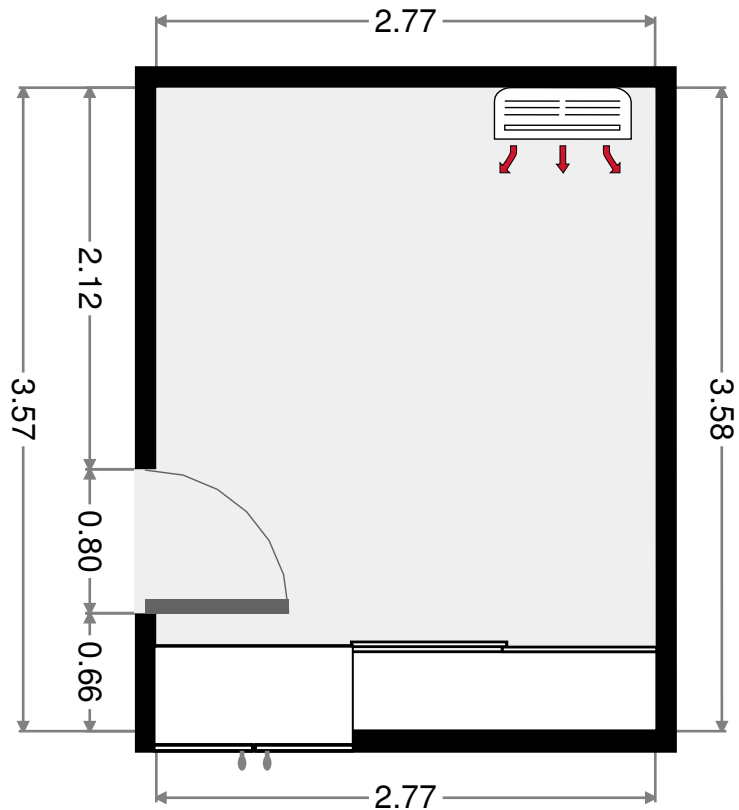
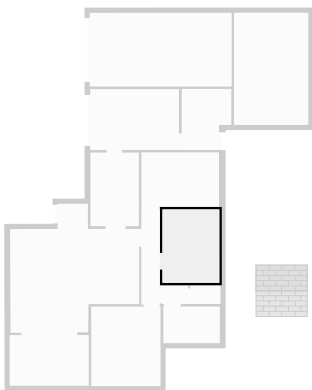

THIS FLOORPLAN IS PROVIDED WITHOUT WARRANTY OF ANY KIND. SENSOPIA DISCLAIMS ANY WARRANTY INCLUDING, WITHOUT LIMITATION, SATISFACTORY QUALITY OR ACCURACY OF DIMENSIONS.

Hall

Width: 0.90 m
 Length: 1.32 m
 Area: 1.18 m²
 Perimeter: 4.42 m

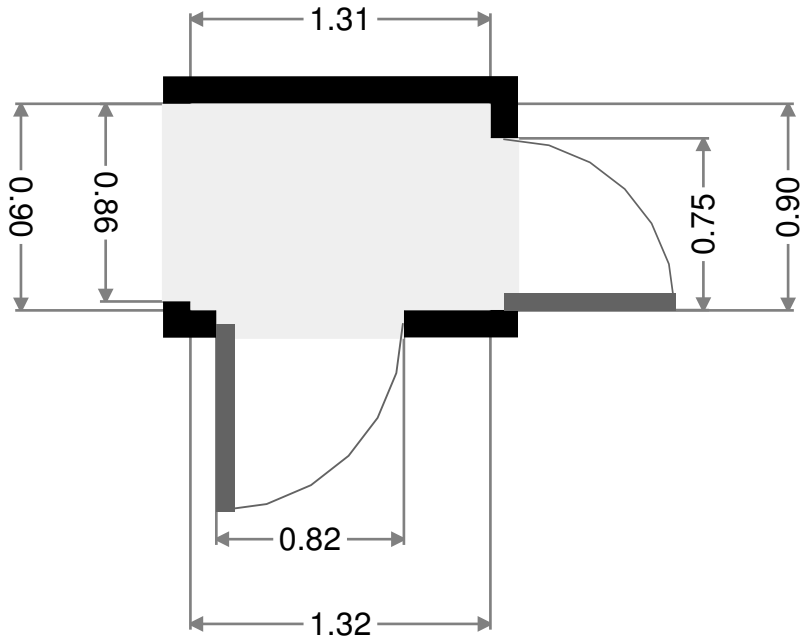
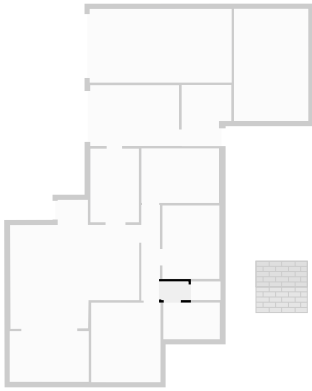

Toilet

Width: 0.91 m
 Length: 1.48 m
 Area: 1.33 m²
 Perimeter: 4.76 m

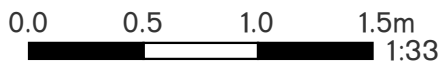
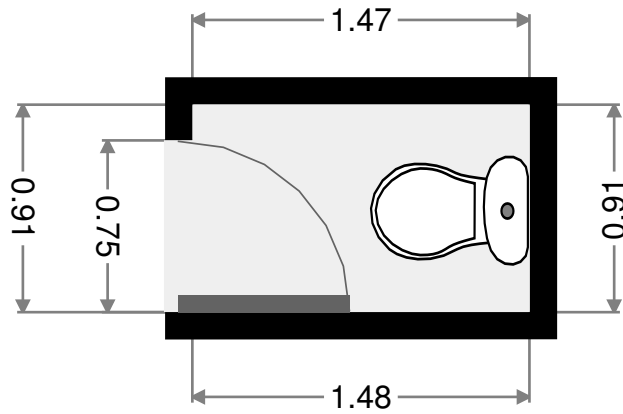
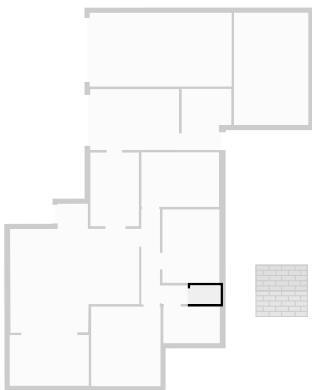

THIS FLOORPLAN IS PROVIDED WITHOUT WARRANTY OF ANY KIND. SENSOPIA DISCLAIMS ANY WARRANTY INCLUDING, WITHOUT LIMITATION, SATISFACTORY QUALITY OR ACCURACY OF DIMENSIONS.

Bathroom

Width: 1.79 m
 Length: 2.75 m
 Area: 4.91 m²
 Perimeter: 9.07 m

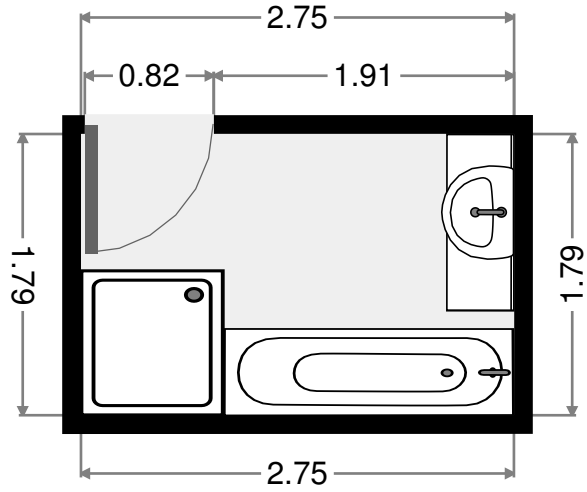
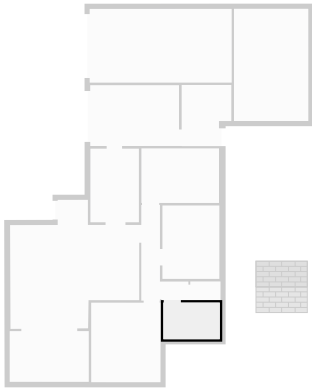

Master Bedroom

Width: 3.37 m
 Length: 3.88 m
 Area: 13.08 m²
 Perimeter: 14.50 m

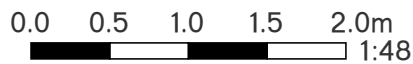
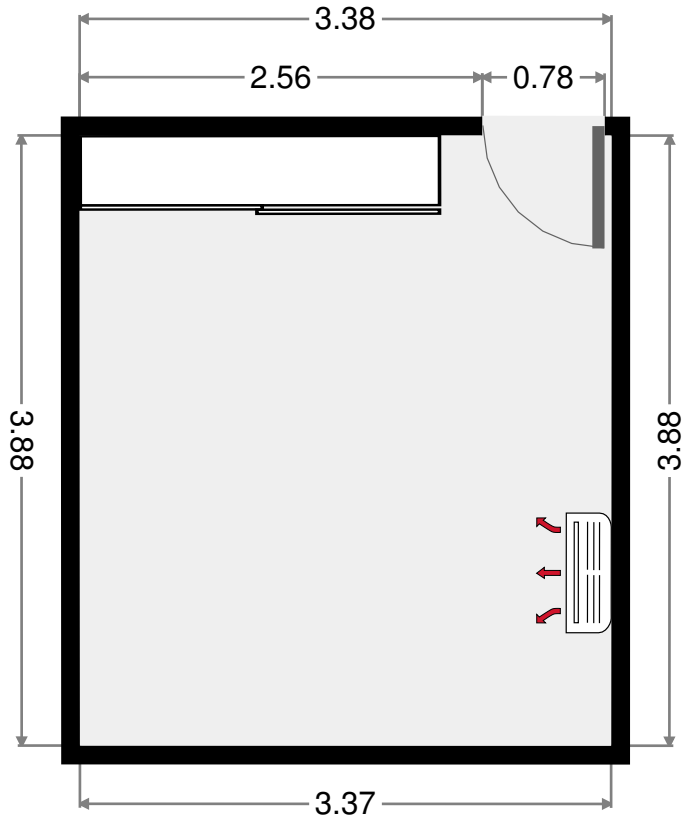

THIS FLOORPLAN IS PROVIDED WITHOUT WARRANTY OF ANY KIND. SENSOPIA DISCLAIMS ANY WARRANTY INCLUDING, WITHOUT LIMITATION, SATISFACTORY QUALITY OR ACCURACY OF DIMENSIONS.

Outdoor Area

Width: 2.47 m
Length: 3.86 m
Area: 9.52 m²
Perimeter: 12.65 m

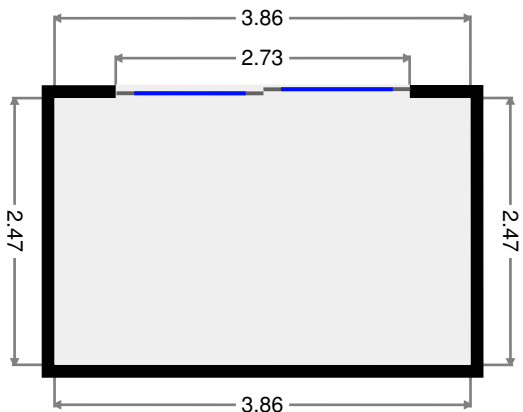
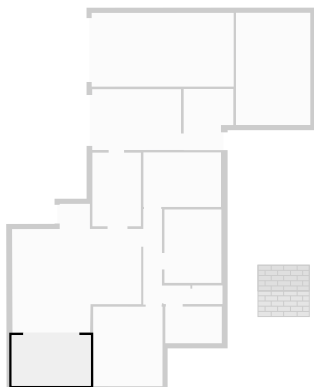

Garage

Width: 3.59 m
Length: 6.92 m
Area: 24.85 m²
Perimeter: 21.02 m

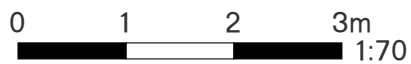
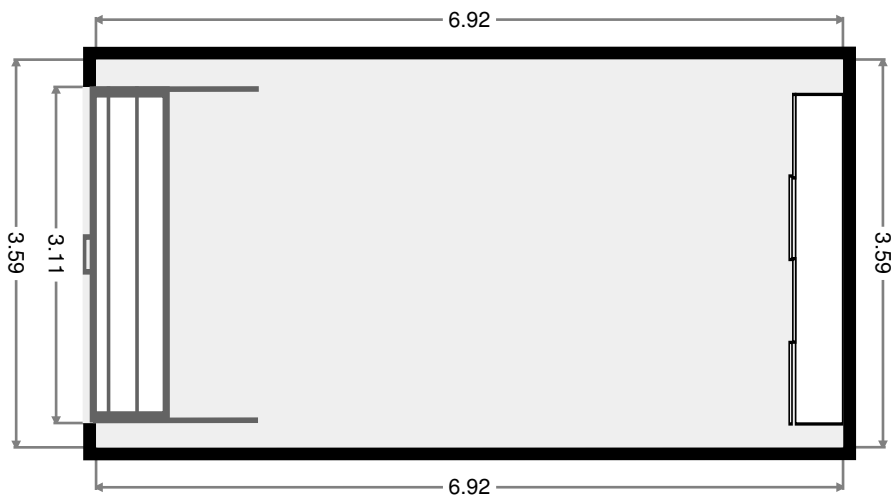
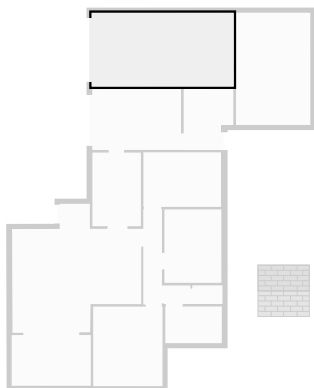

THIS FLOORPLAN IS PROVIDED WITHOUT WARRANTY OF ANY KIND. SENSOPIA DISCLAIMS ANY WARRANTY INCLUDING, WITHOUT LIMITATION, SATISFACTORY QUALITY OR ACCURACY OF DIMENSIONS.