

6 Retreat Avenue

Ground Floor

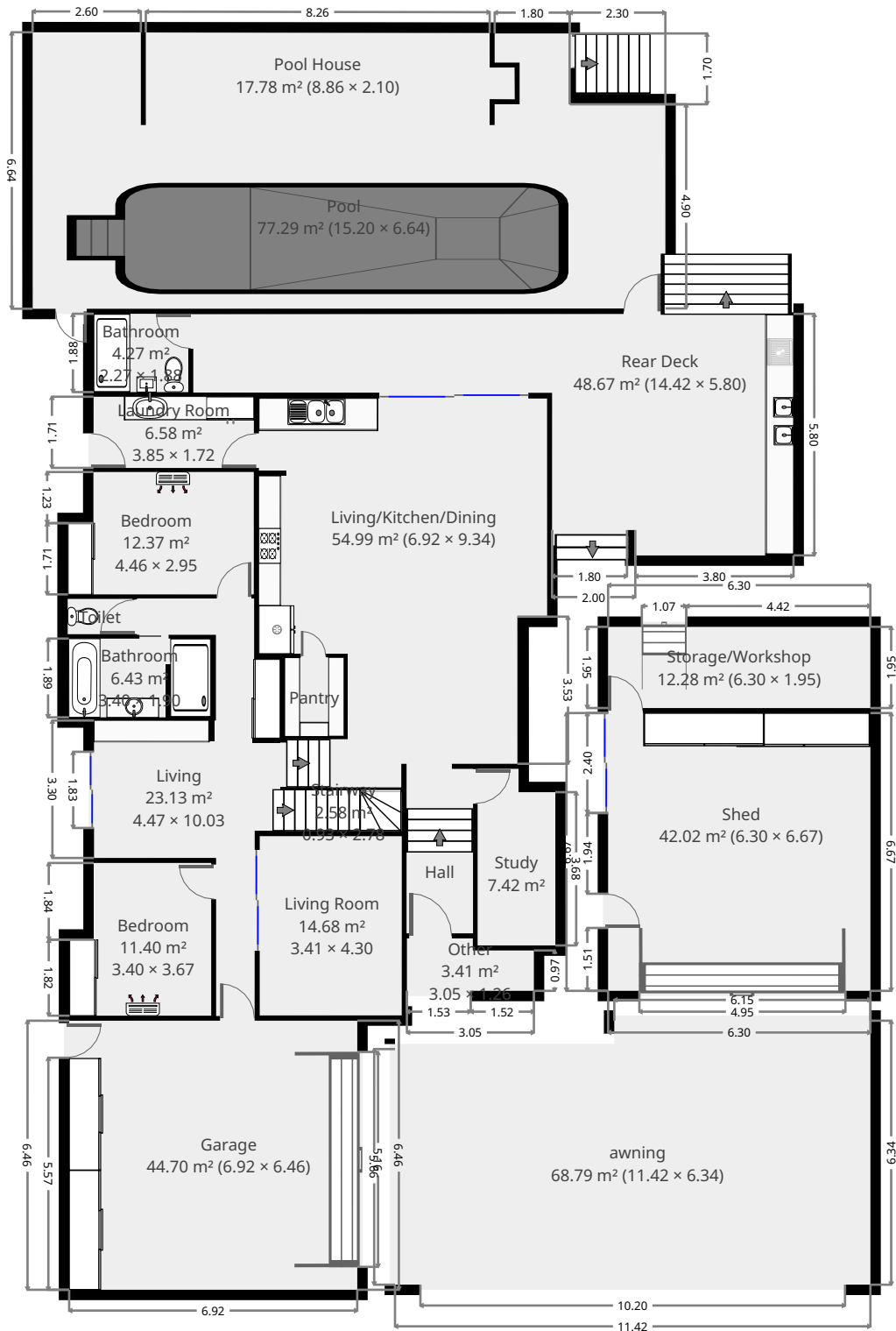

THIS FLOORPLAN IS PROVIDED WITHOUT WARRANTY OF ANY KIND. SENSOPIA DISCLAIMS ANY WARRANTY INCLUDING, WITHOUT LIMITATION, SATISFACTORY QUALITY OR ACCURACY OF DIMENSIONS.



6 Retreat Avenue

Toilet

Width: 0.85 m
Length: 1.55 m
Area: 1.32 m²
Perimeter: 4.80 m

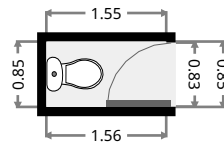
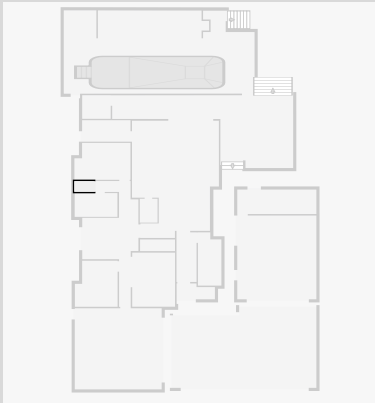

awning

Width: 6.34 m
Length: 11.42 m
Area: 68.79 m²
Perimeter: 35.52 m

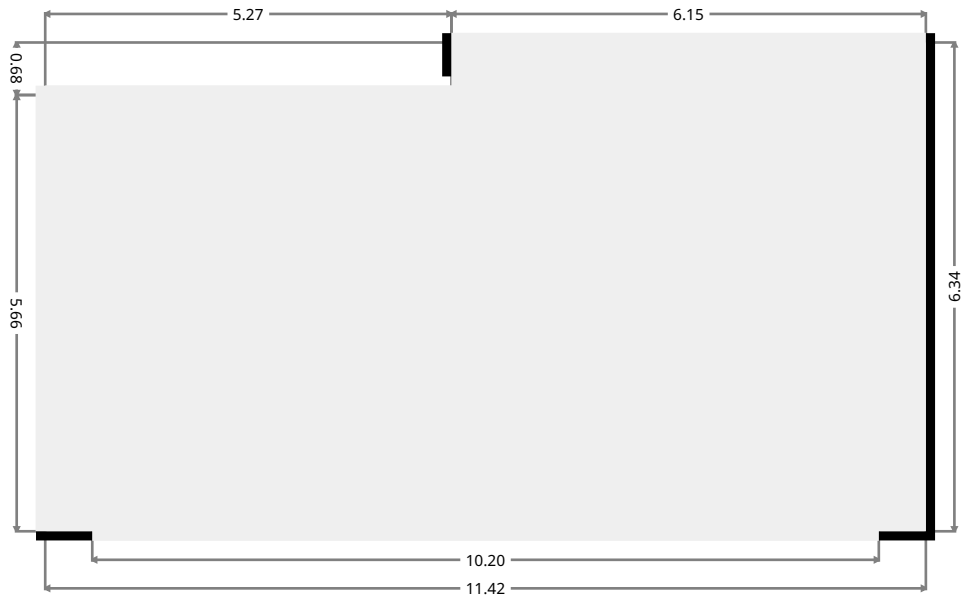
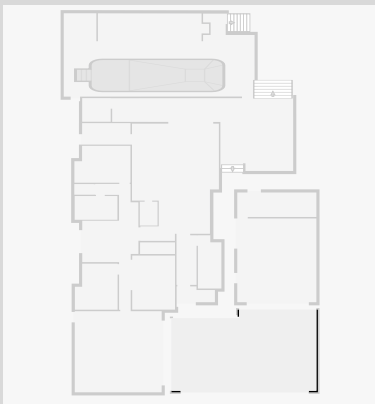

6 Retreat Avenue

Pool House

Width: 2.10 m
 Length: 8.86 m
 Area: 17.78 m²
 Perimeter: 21.92 m

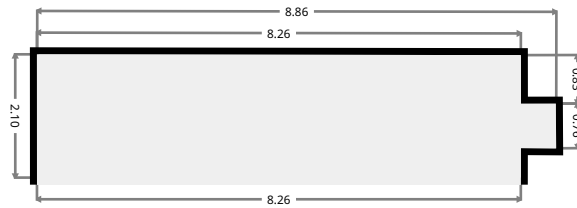
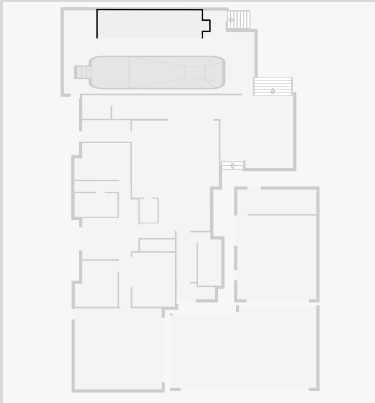

Pool

Width: 6.64 m
 Length: 15.20 m
 Area: 77.29 m²
 Perimeter: 49.27 m

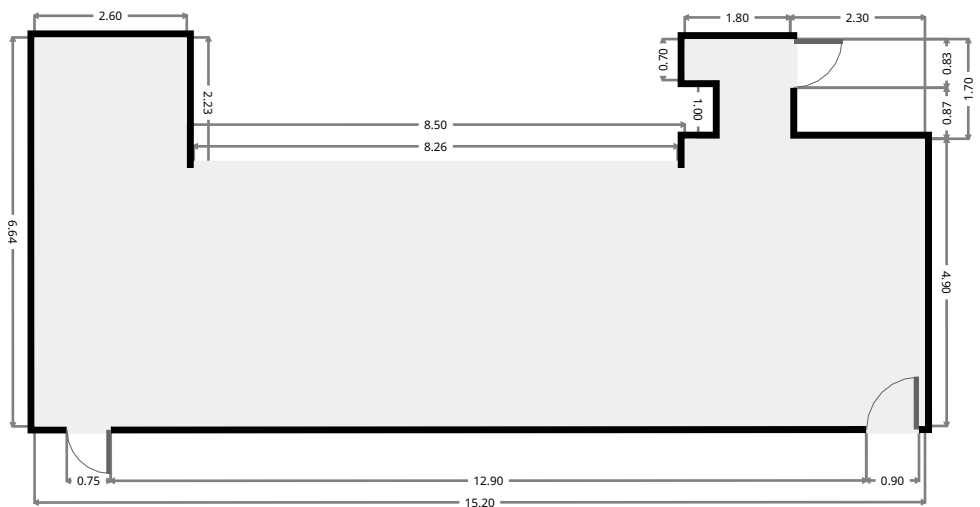
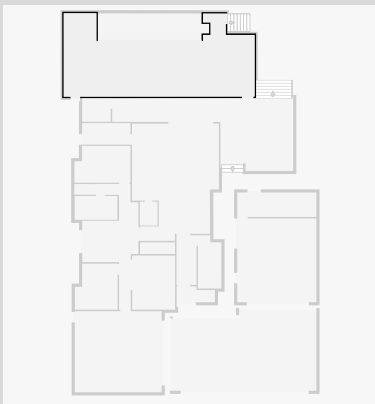

THIS FLOORPLAN IS PROVIDED WITHOUT WARRANTY OF ANY KIND. SENSOPIA DISCLAIMS ANY WARRANTY INCLUDING, WITHOUT LIMITATION, SATISFACTORY QUALITY OR ACCURACY OF DIMENSIONS.

6 Retreat Avenue

Rear Deck

Width: 5.80 m
Length: 14.42 m
Area: 48.67 m²
Perimeter: 40.42 m

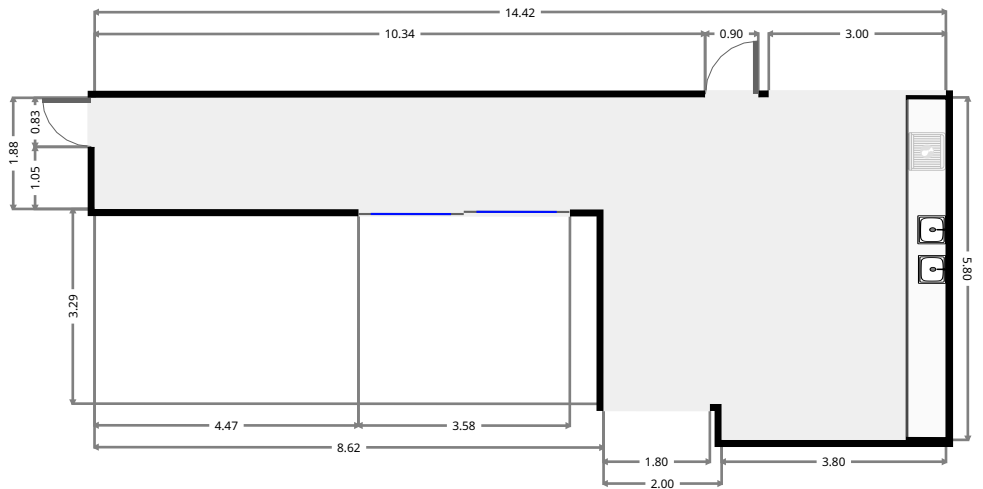
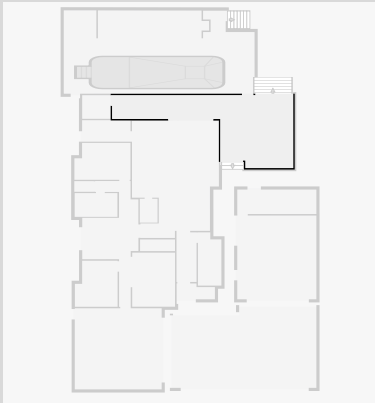

THIS FLOORPLAN IS PROVIDED WITHOUT WARRANTY OF ANY KIND. SENSOPIA DISCLAIMS ANY WARRANTY INCLUDING, WITHOUT LIMITATION, SATISFACTORY QUALITY OR ACCURACY OF DIMENSIONS.



6 Retreat Avenue

Bathroom

Width: 1.88 m
Length: 2.27 m
Area: 4.27 m²
Perimeter: 8.30 m

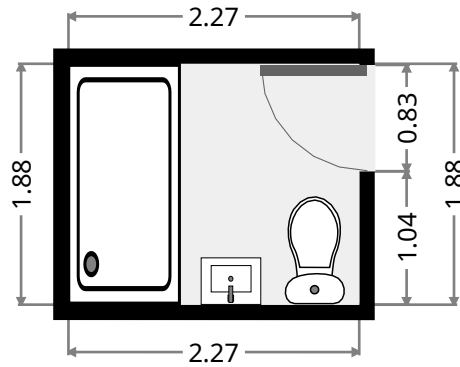
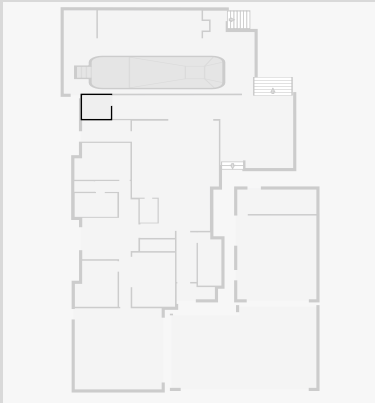

Storage/Workshop

Width: 1.95 m
Length: 6.30 m
Area: 12.28 m²
Perimeter: 16.50 m

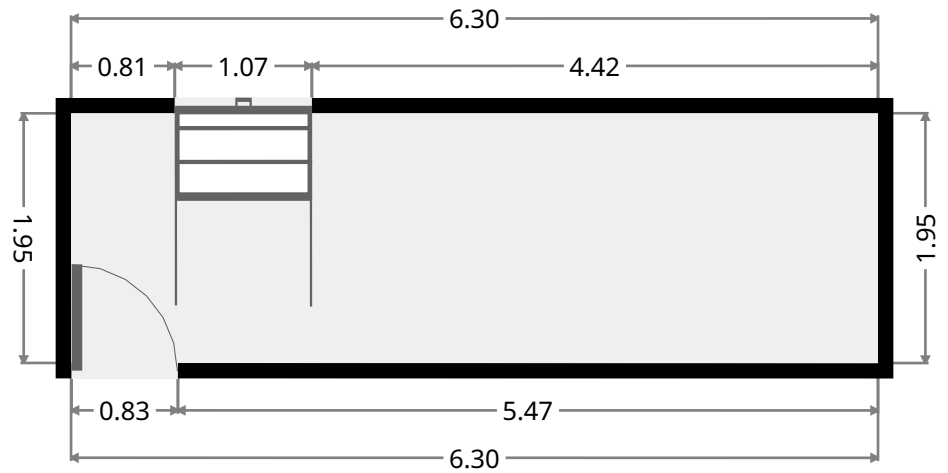
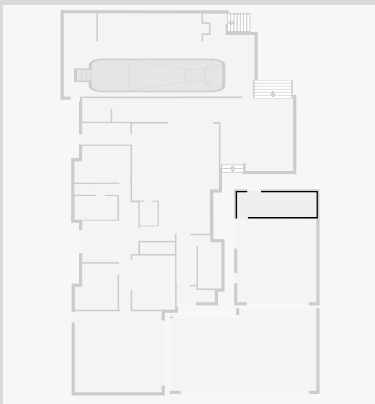

6 Retreat Avenue

Shed

Width: 6.30 m
 Length: 6.67 m
 Area: 42.02 m²
 Perimeter: 25.94 m

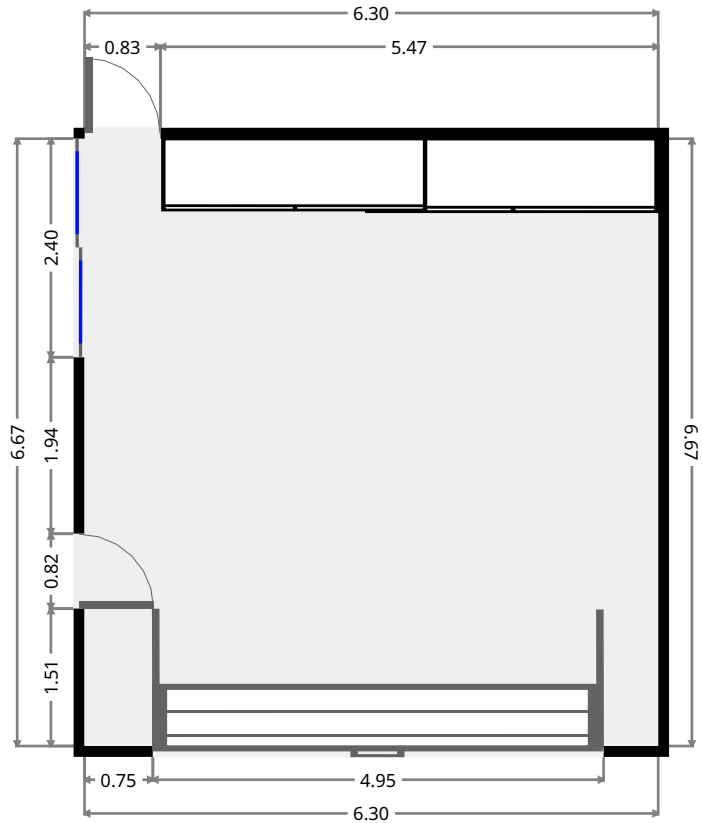
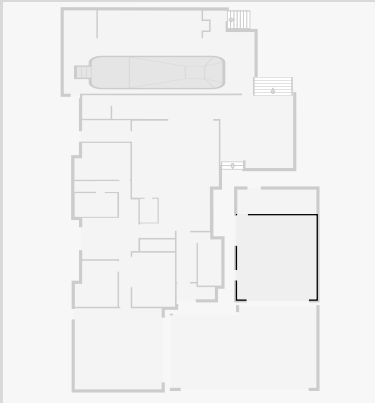

Other

Width: 1.26 m
 Length: 3.05 m
 Area: 3.41 m²
 Perimeter: 8.62 m

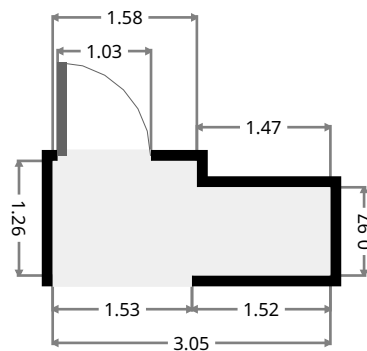
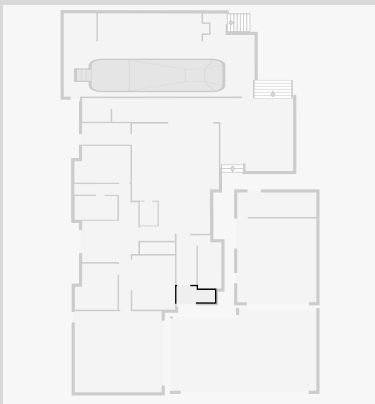

6 Retreat Avenue

Garage

Width: 6.46 m
Length: 6.92 m
Area: 44.70 m²
Perimeter: 26.76 m

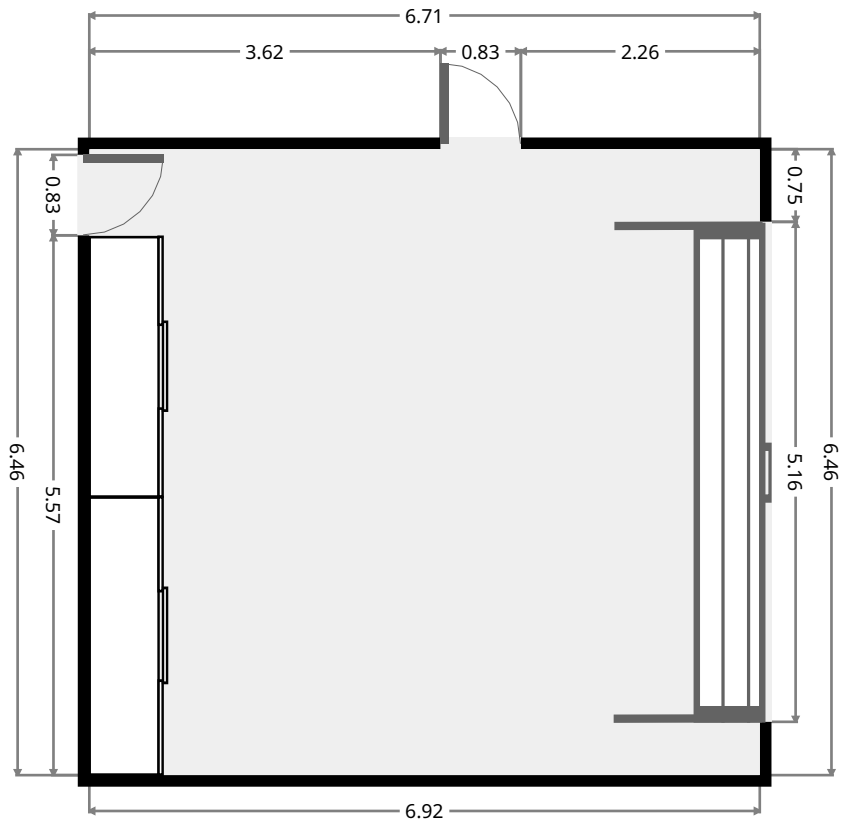
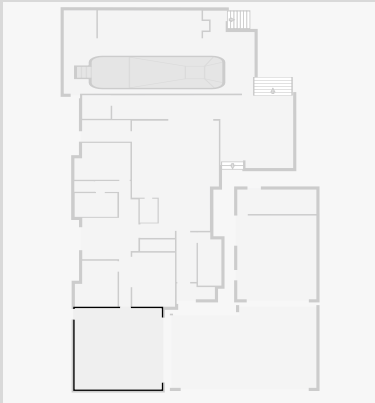

Bathroom

Width: 1.90 m
Length: 3.40 m
Area: 6.43 m²
Perimeter: 10.59 m

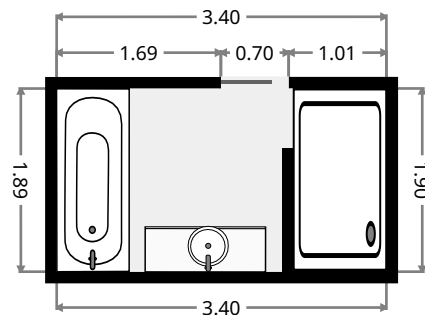
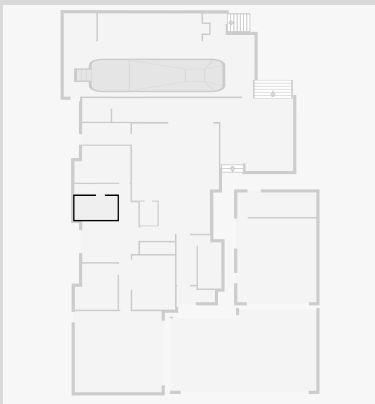

6 Retreat Avenue

Hall

Width: 1.60 m
 Length: 3.95 m
 Area: 6.31 m²
 Perimeter: 11.10 m

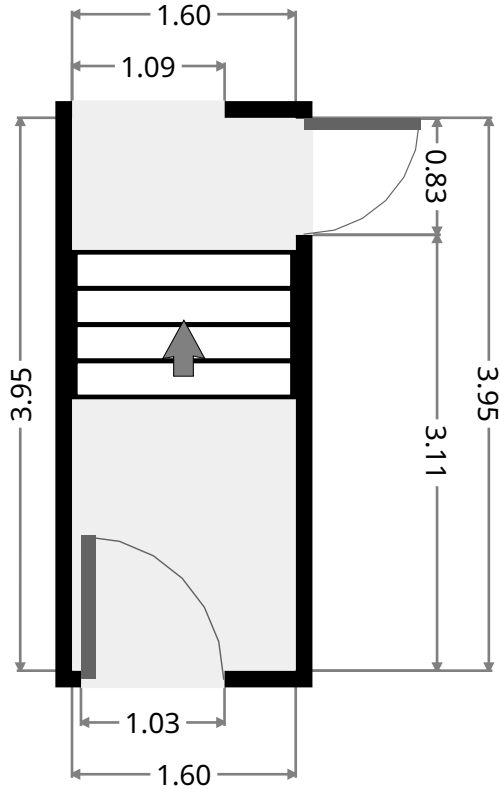
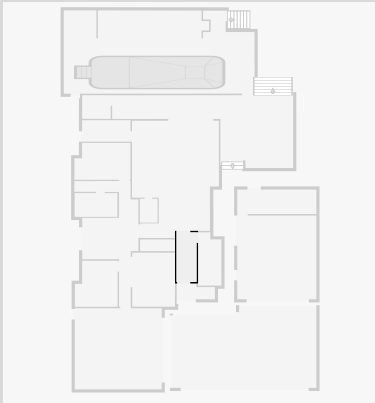

Bedroom

Width: 2.95 m
 Length: 4.46 m
 Area: 12.37 m²
 Perimeter: 14.80 m

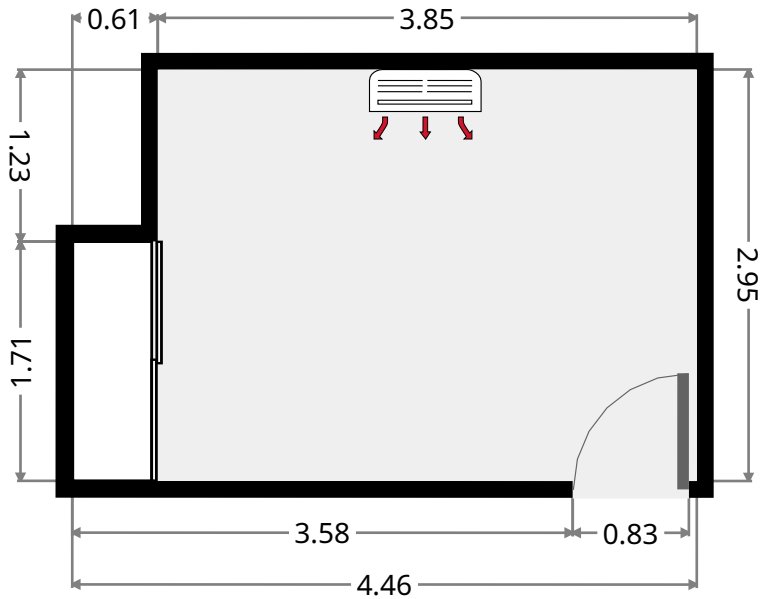
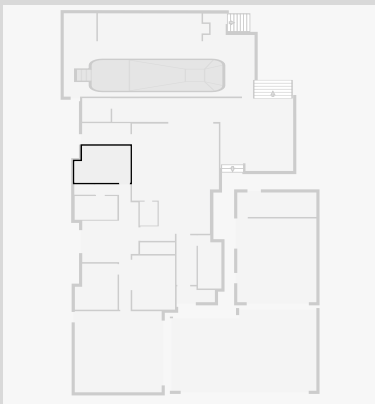

6 Retreat Avenue

Bedroom

Width: 3.40 m
 Length: 3.67 m
 Area: 11.40 m²
 Perimeter: 14.14 m

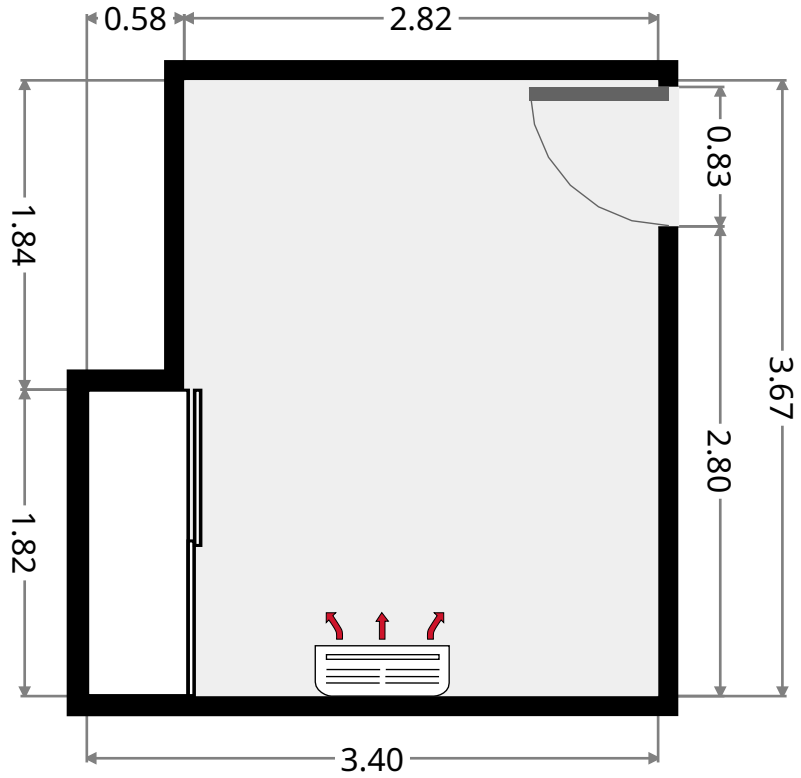
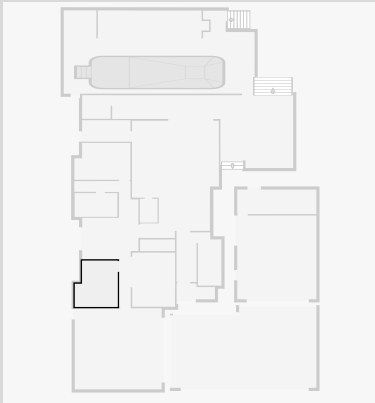

Stairway

Width: 0.93 m
 Length: 2.78 m
 Area: 2.58 m²
 Perimeter: 7.42 m

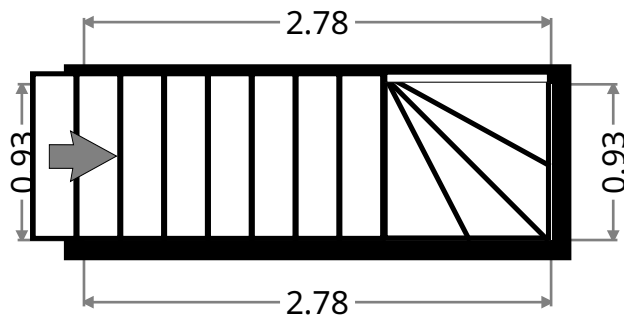

6 Retreat Avenue

Living Room

Width: 3.41 m
 Length: 4.30 m
 Area: 14.68 m²
 Perimeter: 15.43 m

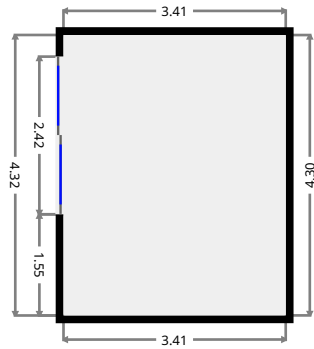
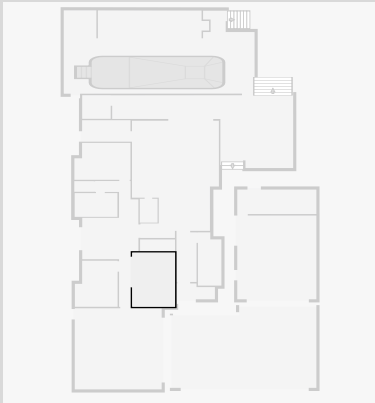

Living

Width: 4.47 m
 Length: 10.03 m
 Area: 23.13 m²
 Perimeter: 32.79 m

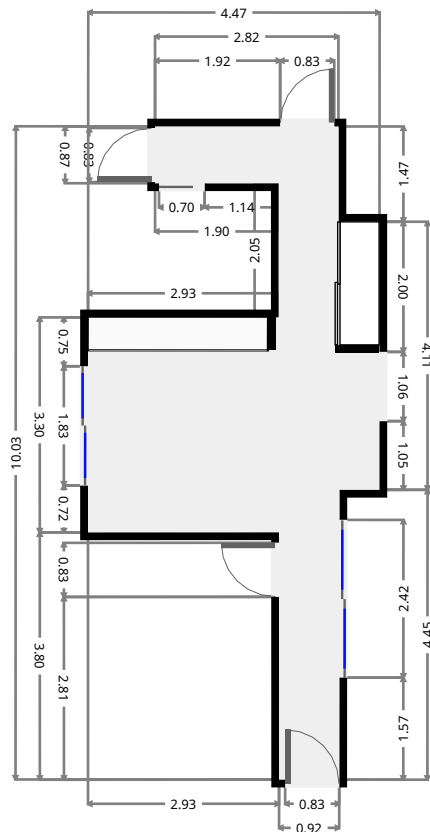
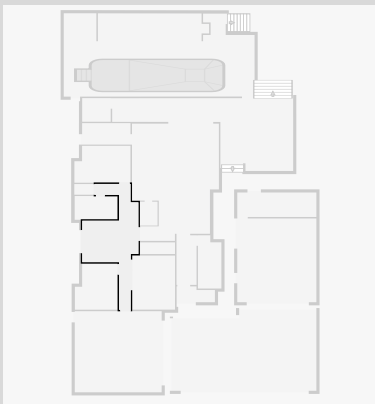

THIS FLOORPLAN IS PROVIDED WITHOUT WARRANTY OF ANY KIND. SENSOPIA DISCLAIMS ANY WARRANTY INCLUDING, WITHOUT LIMITATION, SATISFACTORY QUALITY OR ACCURACY OF DIMENSIONS.

6 Retreat Avenue

Pantry

Width: 1.41 m
 Length: 1.91 m
 Area: 2.69 m²
 Perimeter: 6.63 m

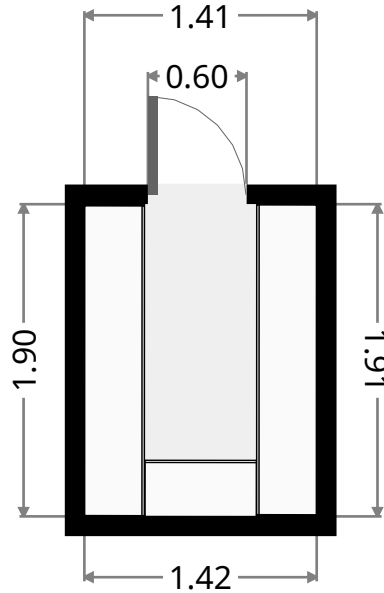
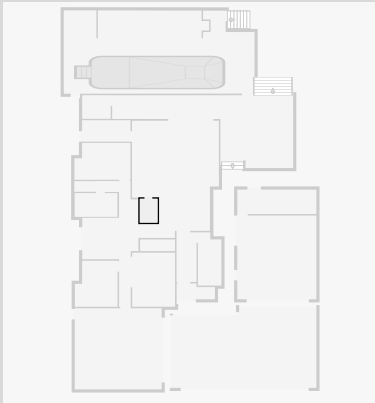

Laundry Room

Width: 1.72 m
 Length: 3.85 m
 Area: 6.58 m²
 Perimeter: 11.12 m

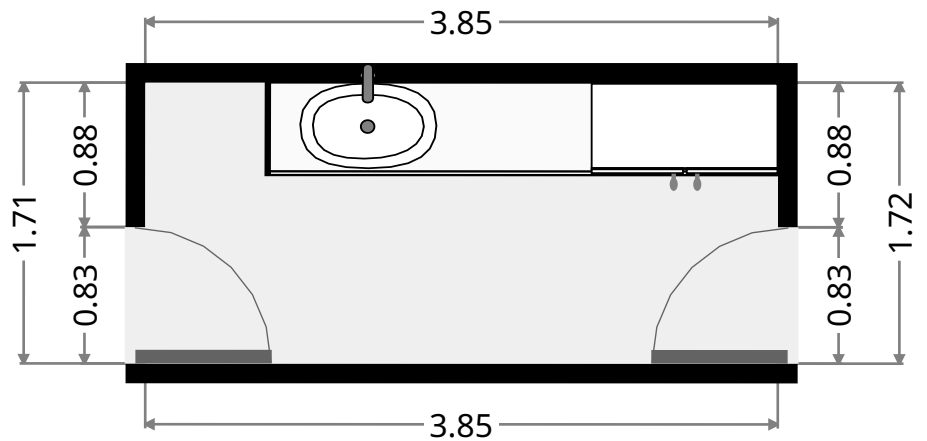
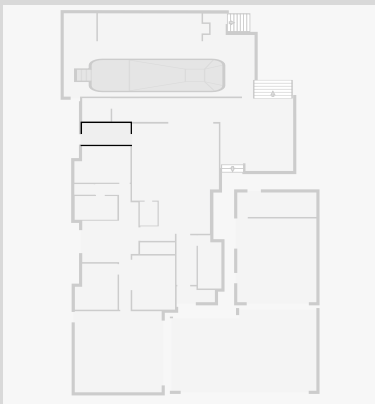

6 Retreat Avenue

Living/Kitchen/Dining

Width: 6.92 m
 Length: 9.34 m
 Area: 54.99 m²
 Perimeter: 35.45 m

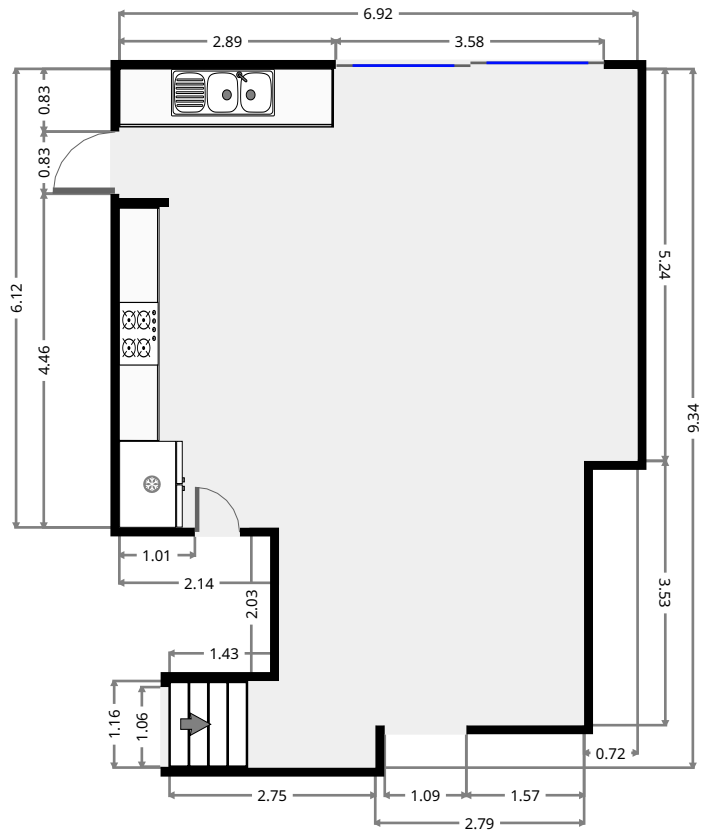
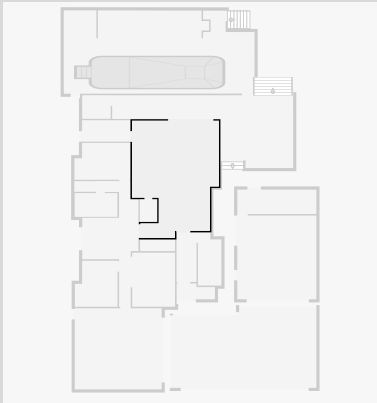

Study

Width: 1.87 m
 Length: 4.24 m
 Area: 7.42 m²
 Perimeter: 12.22 m

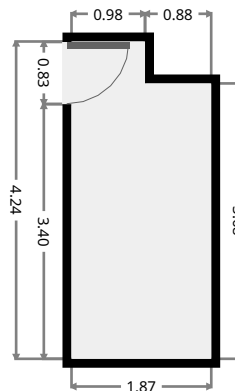
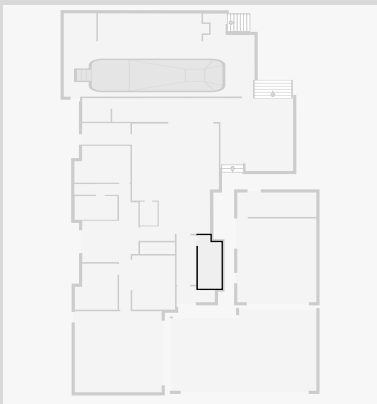

6 Retreat Avenue

2nd Floor

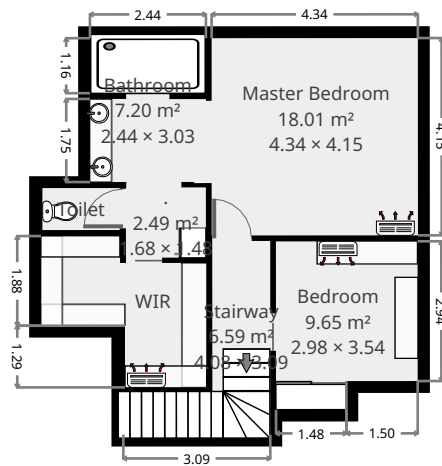

THIS FLOORPLAN IS PROVIDED WITHOUT WARRANTY OF ANY KIND. SENSOPIA DISCLAIMS ANY WARRANTY INCLUDING, WITHOUT LIMITATION, SATISFACTORY QUALITY OR ACCURACY OF DIMENSIONS.



6 Retreat Avenue

Master Bedroom

Width: 4.15 m
 Length: 4.34 m
 Area: 18.01 m²
 Perimeter: 16.98 m

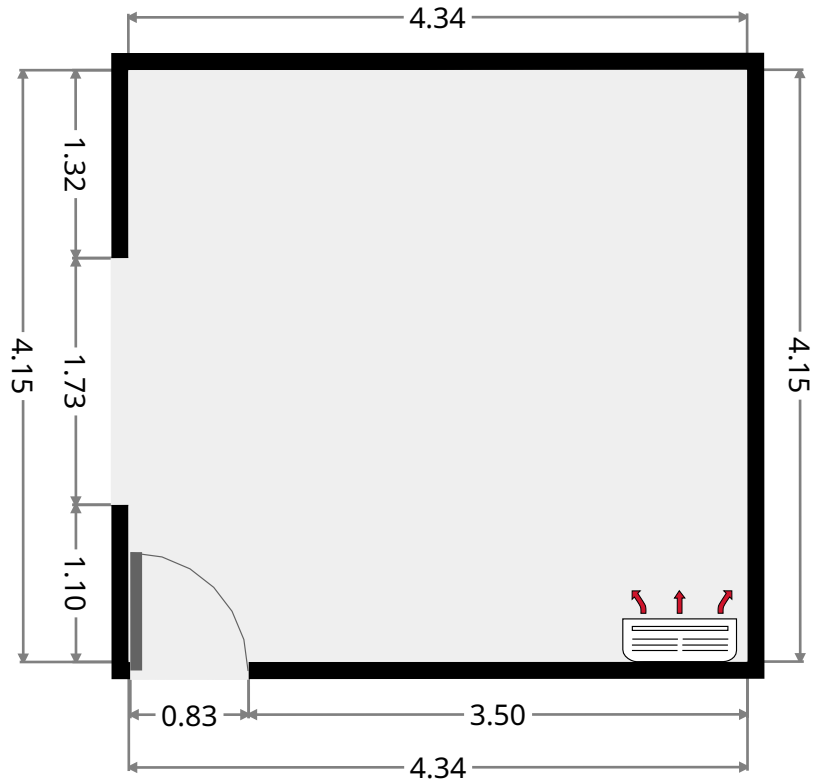
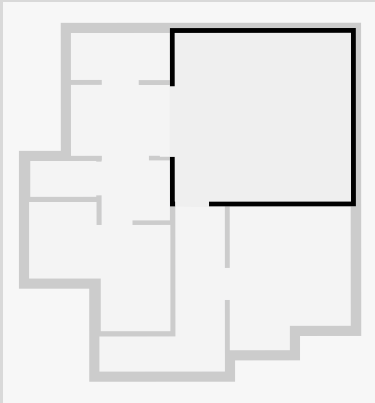

Bathroom

Width: 2.44 m
 Length: 3.03 m
 Area: 7.20 m²
 Perimeter: 13.99 m

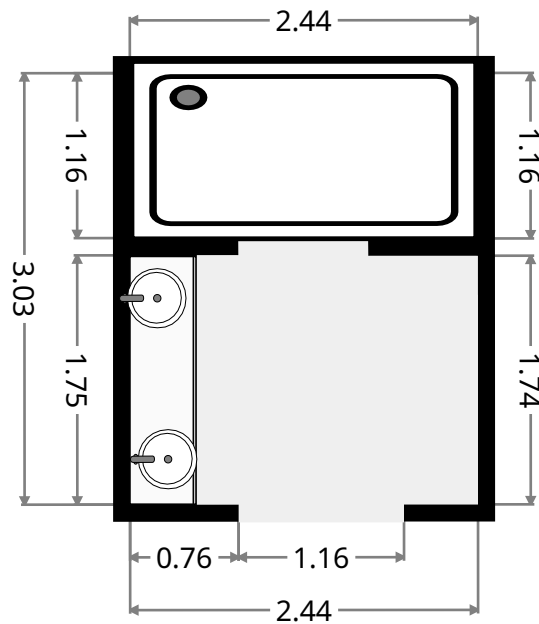
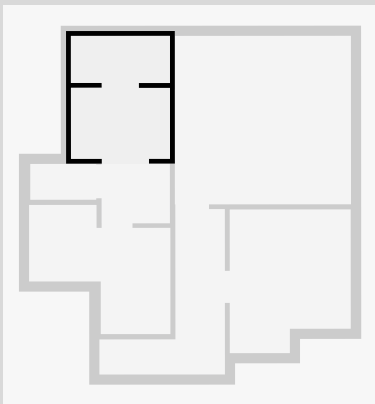

6 Retreat Avenue

•
 Width: 1.48 m
 Length: 1.68 m
 Area: 2.49 m²
 Perimeter: 6.32 m

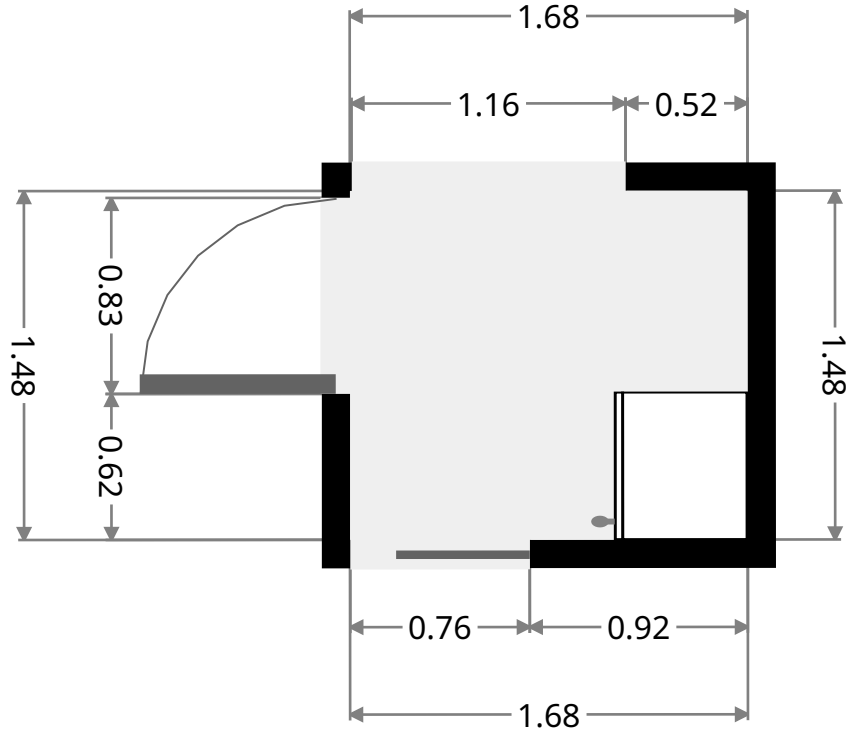
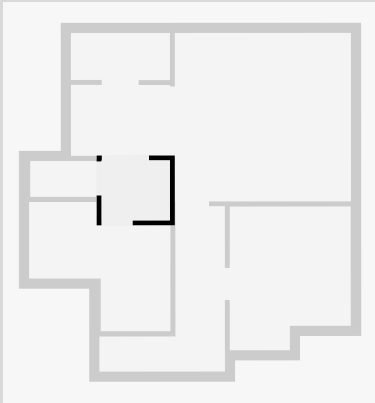

Toilet

Width: 0.88 m
 Length: 1.62 m
 Area: 1.44 m²
 Perimeter: 5.02 m

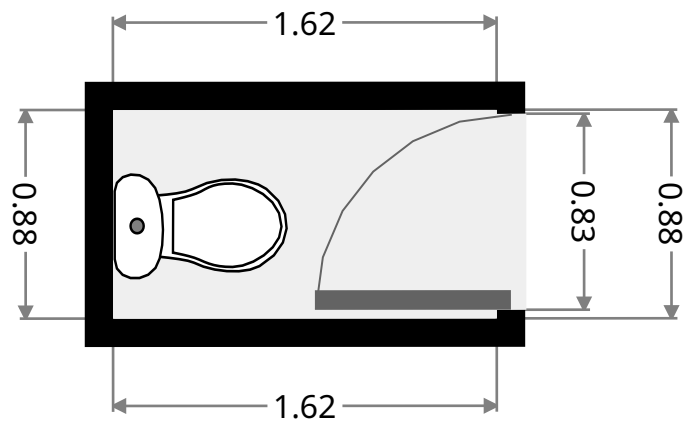
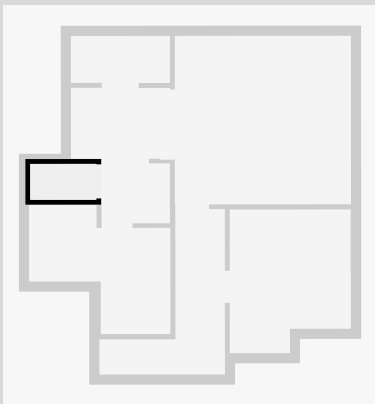

6 Retreat Avenue

WIR

Width: 3.18 m
 Length: 3.48 m
 Area: 7.76 m²
 Perimeter: 13.33 m

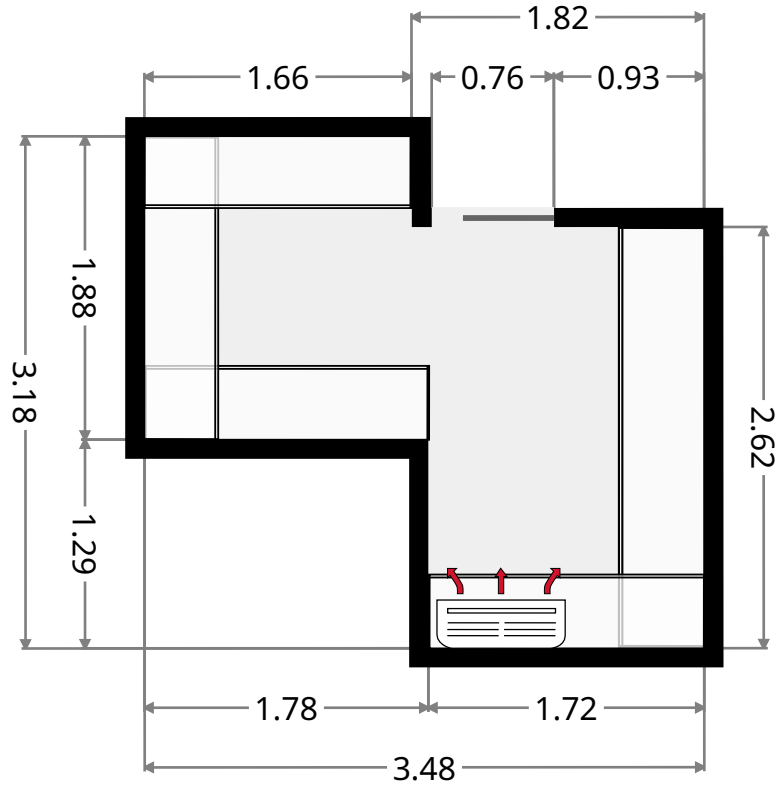
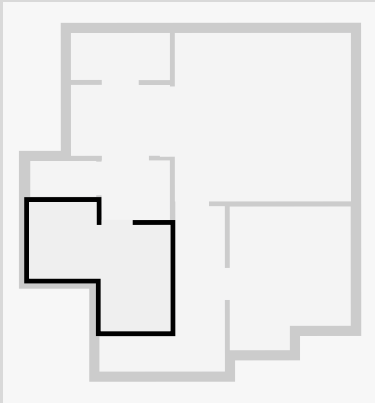

Bedroom

Width: 2.98 m
 Length: 3.54 m
 Area: 9.65 m²
 Perimeter: 13.04 m

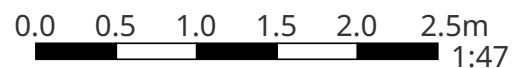
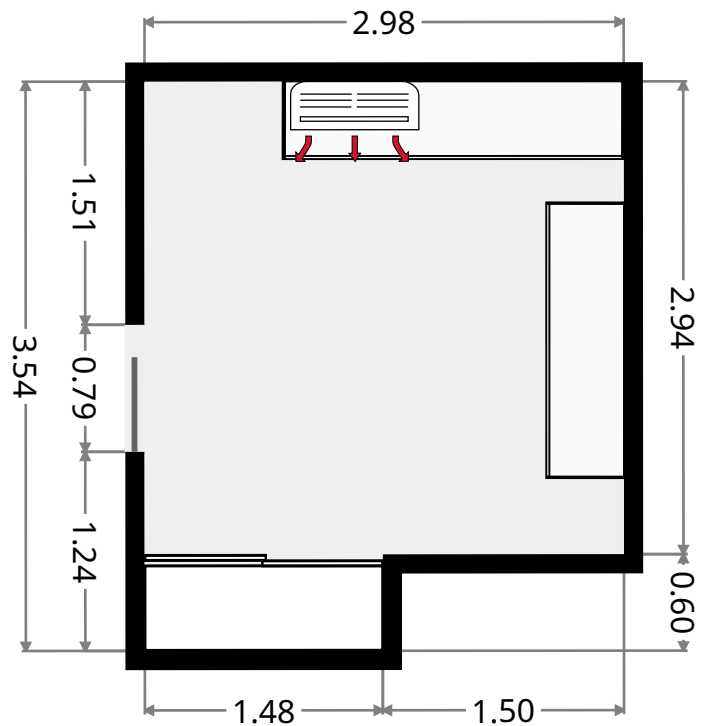
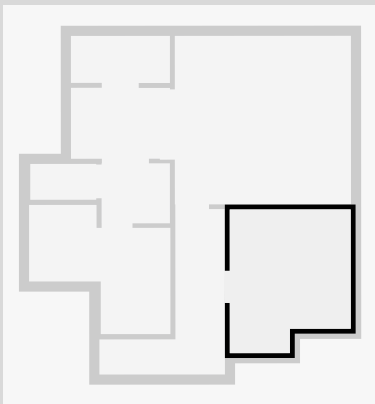

THIS FLOORPLAN IS PROVIDED WITHOUT WARRANTY OF ANY KIND. SENSOPIA DISCLAIMS ANY WARRANTY INCLUDING, WITHOUT LIMITATION, SATISFACTORY QUALITY OR ACCURACY OF DIMENSIONS.

6 Retreat Avenue

Stairway

Width: 3.09 m
Length: 4.08 m
Area: 6.59 m²
Perimeter: 14.34 m

