

6 Leichhardt Drive

Created on
2021-09-07

Floors
1

▼ Ground Floor



▼ **Hall**
Ground Floor

WIDTH: 1.25 m • LENGTH: 3.94 m
AREA: 4.93 m² • PERIMETER: 10.38 m

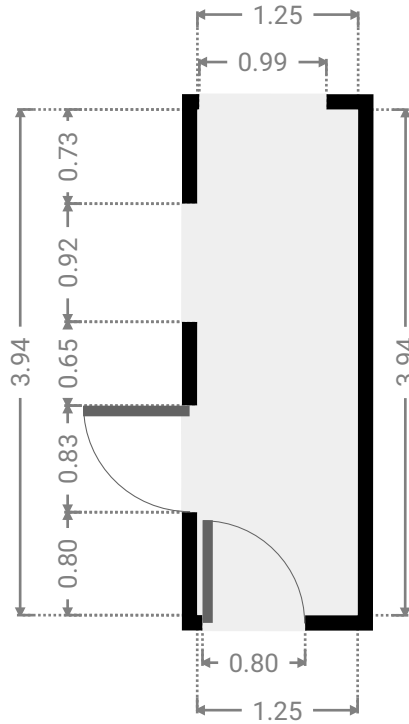
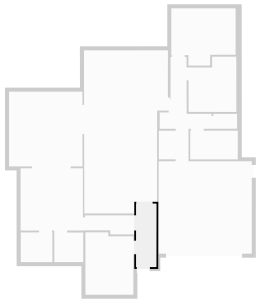

▼ **Bedroom**
Ground Floor

WIDTH: 2.99 m • LENGTH: 3.88 m
AREA: 11.20 m² • PERIMETER: 13.73 m

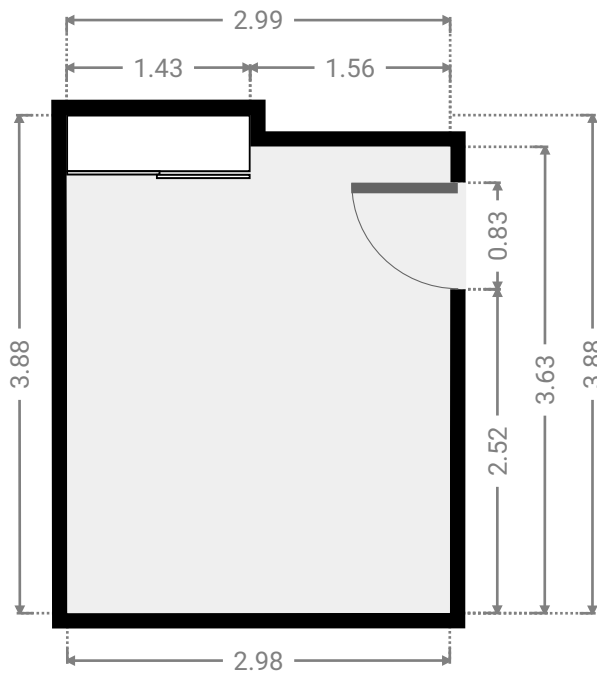
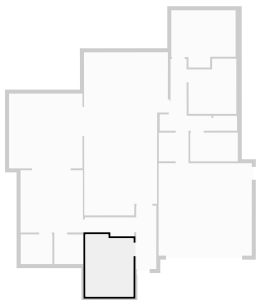

▼ Hall
Ground Floor

WIDTH: 3.07 m • LENGTH: 1.18 m
AREA: 3.23 m² • PERIMETER: 8.51 m

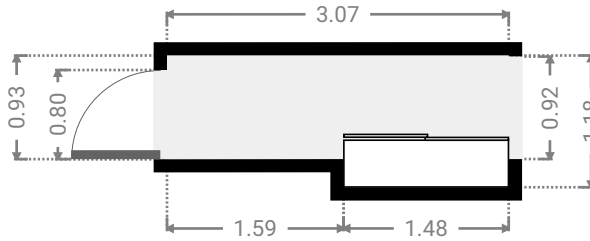

▼ Master Bedroom
Ground Floor

WIDTH: 3.88 m • LENGTH: 3.88 m
AREA: 15.02 m² • PERIMETER: 15.50 m

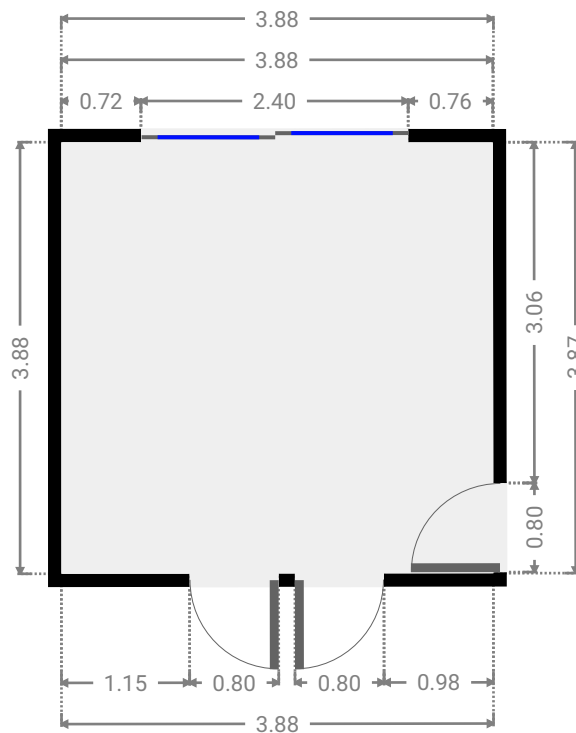
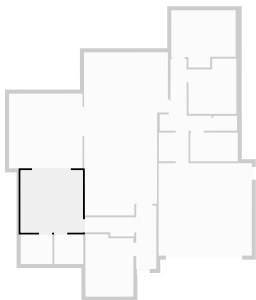

▼ **Closet**
Ground Floor

WIDTH: 1.80 m • LENGTH: 1.84 m
AREA: 3.31 m² • PERIMETER: 7.28 m

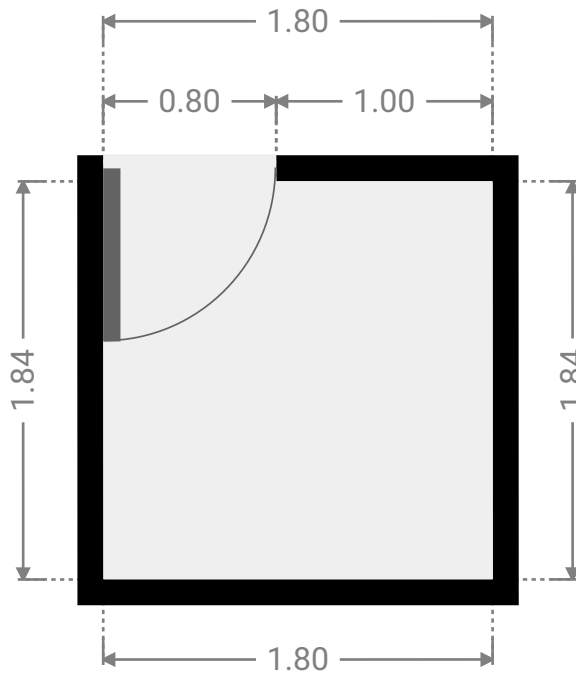
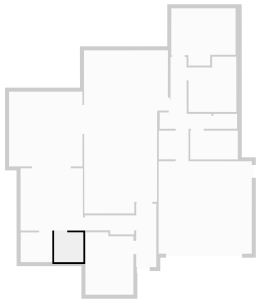

▼ **Bathroom**
Ground Floor

WIDTH: 1.97 m • LENGTH: 1.85 m
AREA: 3.64 m² • PERIMETER: 7.64 m

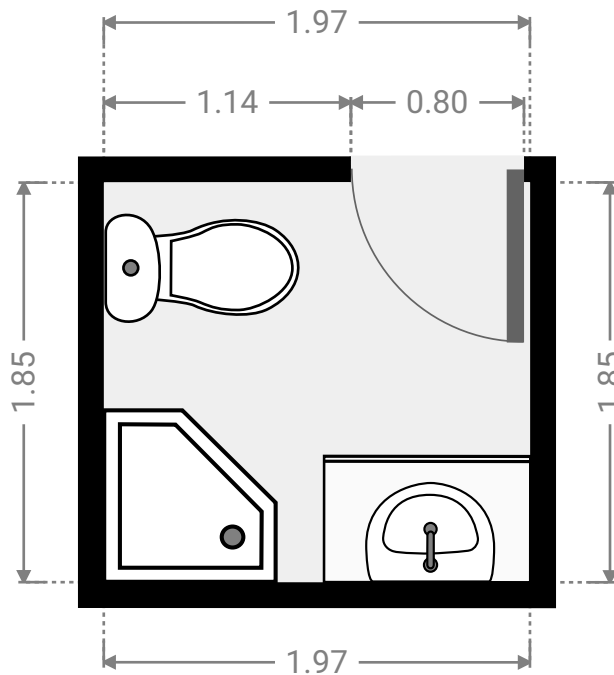
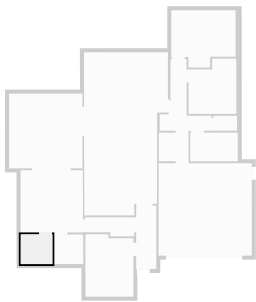

▼ Kitchen
Ground Floor

WIDTH: 5.23 m • LENGTH: 10.16 m
AREA: 47.61 m² • PERIMETER: 30.72 m

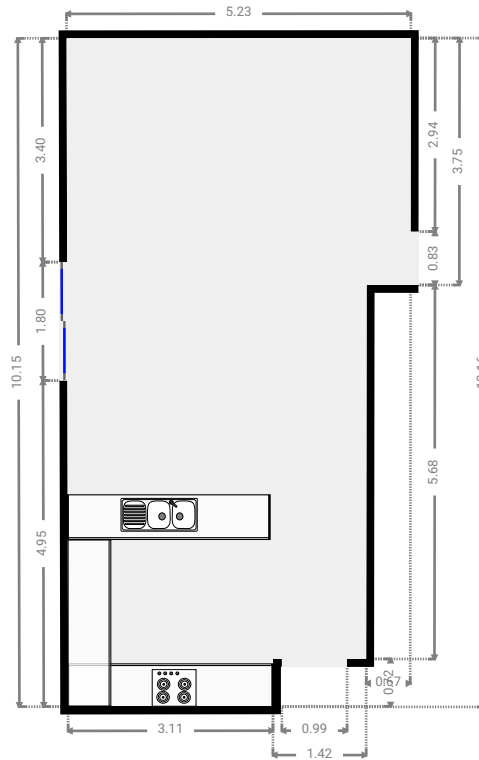
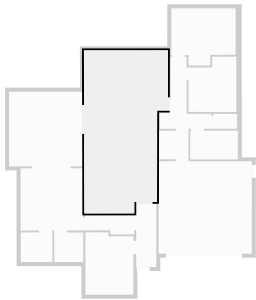

▼ Hall
Ground Floor

WIDTH: 3.22 m • LENGTH: 4.46 m
AREA: 6.68 m² • PERIMETER: 15.36 m

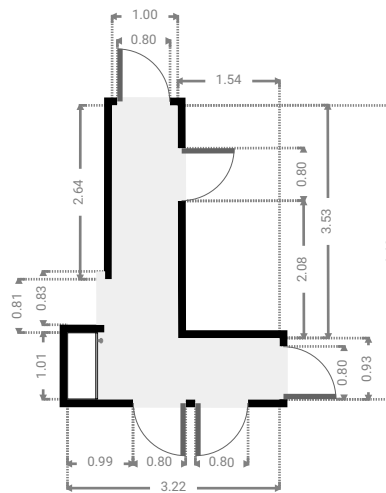
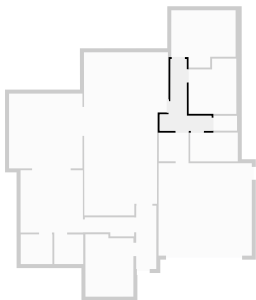

▼ **Bedroom**
Ground Floor

WIDTH: 4.00 m • LENGTH: 3.56 m
AREA: 12.50 m² • PERIMETER: 15.13 m

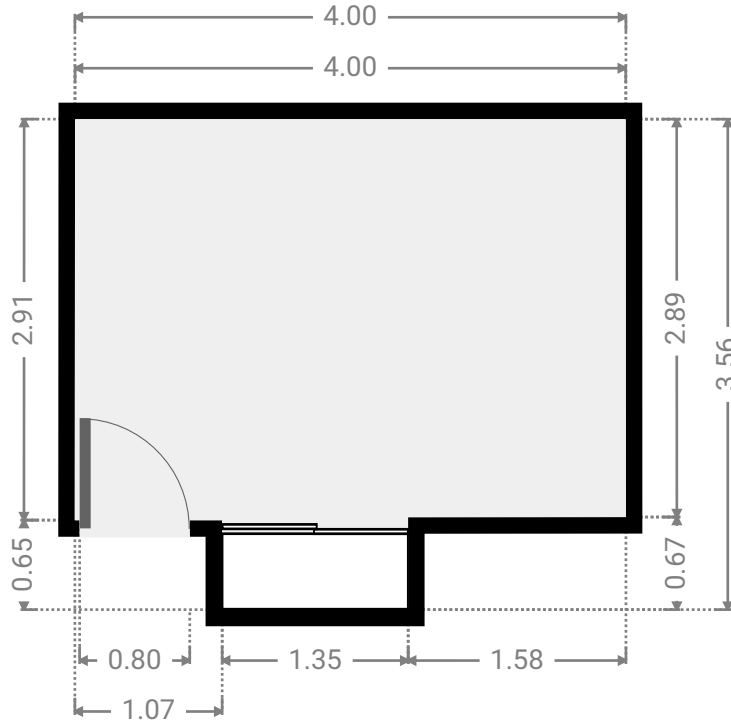
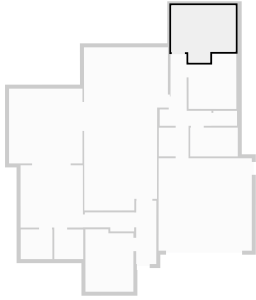

▼ **Bedroom**
Ground Floor

WIDTH: 2.98 m • LENGTH: 3.44 m
AREA: 9.23 m² • PERIMETER: 12.82 m

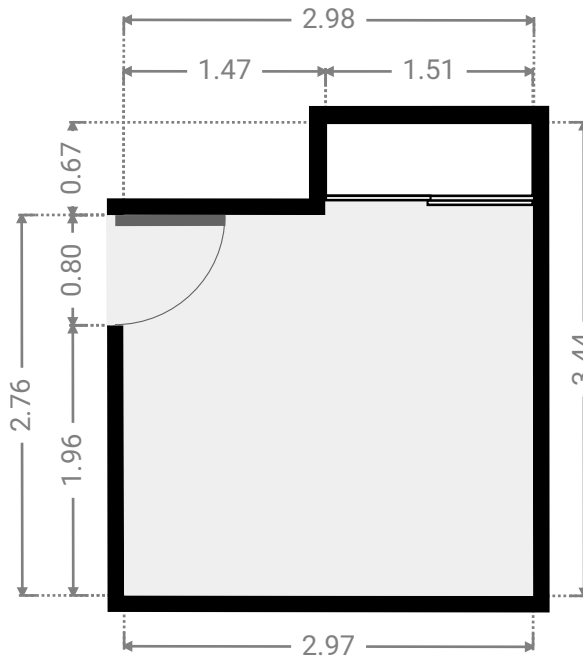
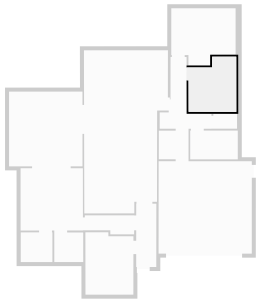

▼ Toilet
Ground Floor

WIDTH: 1.47 m • LENGTH: 0.92 m
AREA: 1.36 m² • PERIMETER: 4.80 m

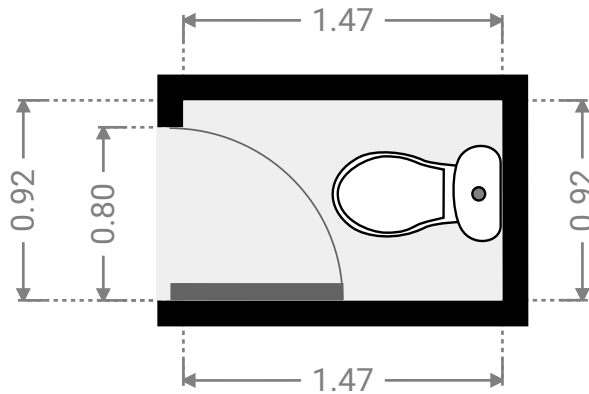
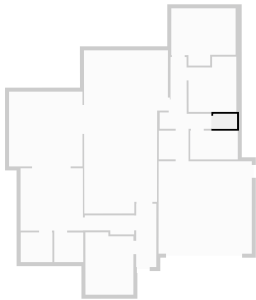

▼ Bathroom
Ground Floor

WIDTH: 2.96 m • LENGTH: 1.79 m
AREA: 5.30 m² • PERIMETER: 9.50 m

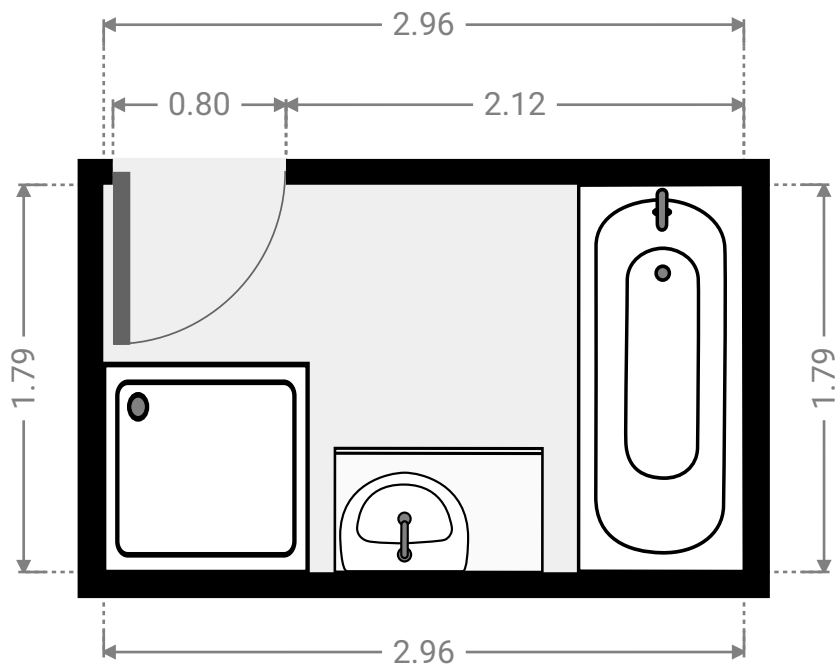
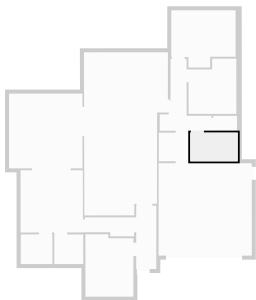

▼ Laundry Room
Ground Floor

WIDTH: 1.85 m • LENGTH: 1.78 m
AREA: 3.29 m² • PERIMETER: 7.26 m

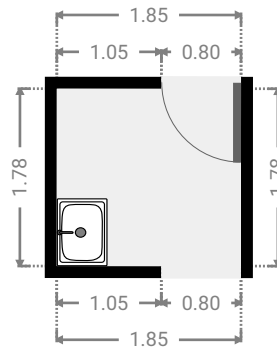
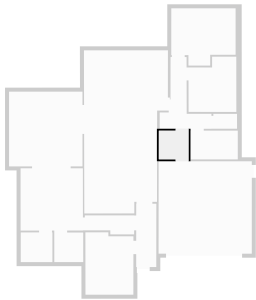

▼ Garage
Ground Floor

WIDTH: 5.80 m • LENGTH: 5.75 m
AREA: 33.34 m² • PERIMETER: 23.10 m

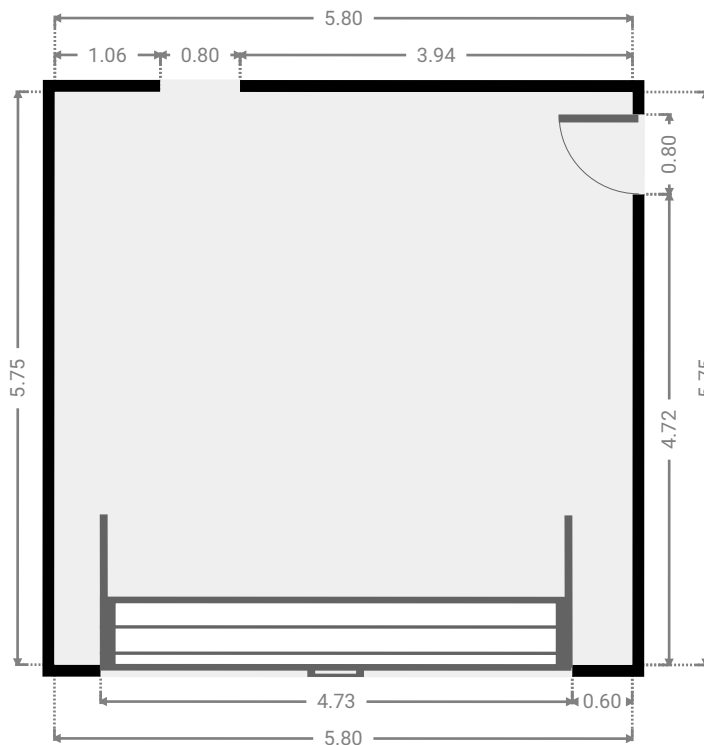
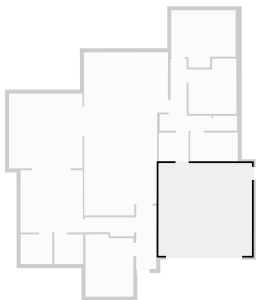

▼ Other
Ground Floor

WIDTH: 4.57 m • LENGTH: 4.65 m
AREA: 21.25 m² • PERIMETER: 18.44 m

