

# 6 Bean Street

## Ground Floor



THIS FLOORPLAN IS PROVIDED WITHOUT WARRANTY OF ANY KIND. SENSOPIA DISCLAIMS ANY WARRANTY INCLUDING, WITHOUT LIMITATION, SATISFACTORY QUALITY OR ACCURACY OF DIMENSIONS.



# 6 Bean Street

## Bedroom

Width: 2.43 m  
Length: 3.67 m  
Area: 8.91 m<sup>2</sup>  
Perimeter: 12.19 m

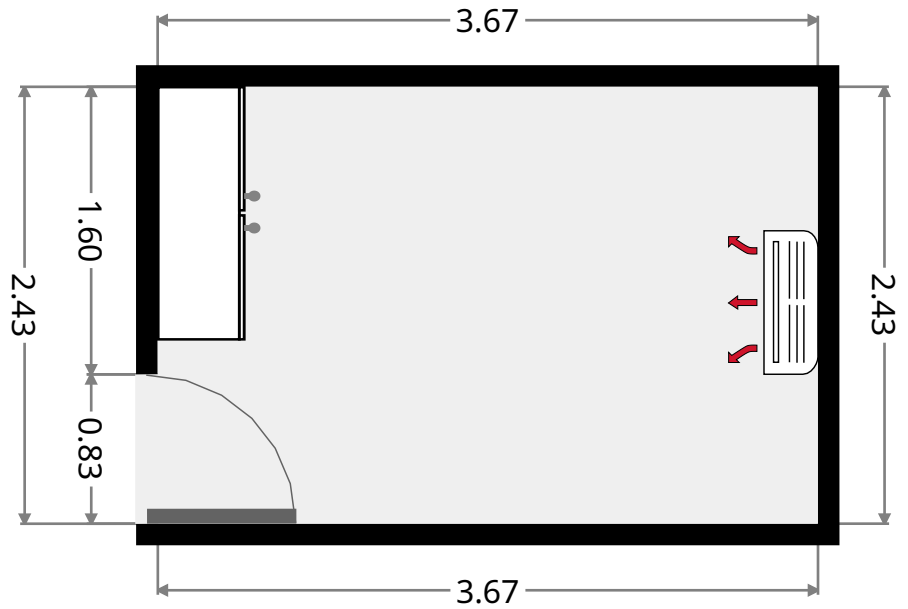
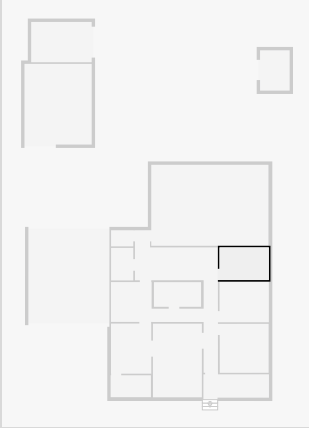

## Shed

Width: 2.20 m  
Length: 3.00 m  
Area: 6.59 m<sup>2</sup>  
Perimeter: 10.39 m

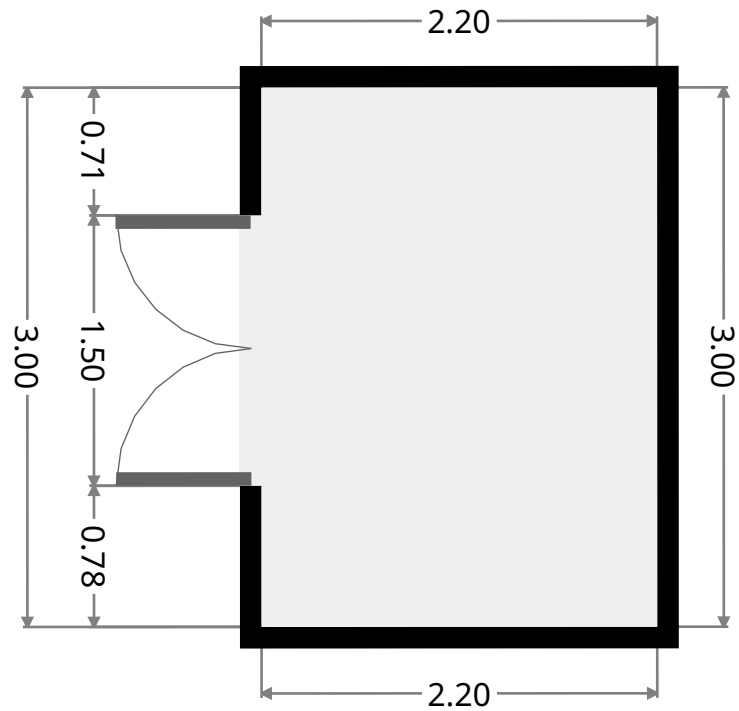
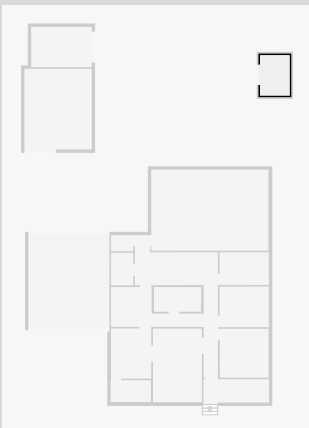

# 6 Bean Street

## Shed

Width: 3.00 m  
Length: 4.50 m  
Area: 13.49 m<sup>2</sup>  
Perimeter: 14.99 m

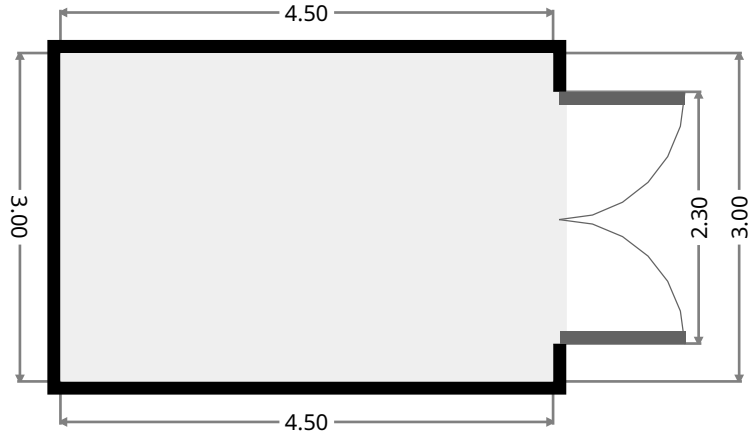
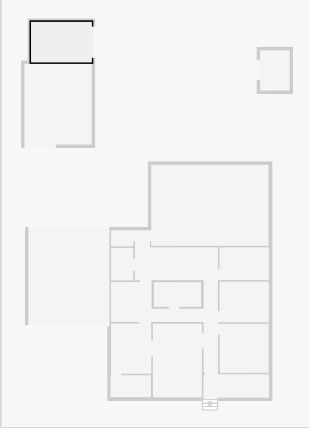

## Shed

Width: 5.00 m  
Length: 6.00 m  
Area: 29.99 m<sup>2</sup>  
Perimeter: 22.00 m

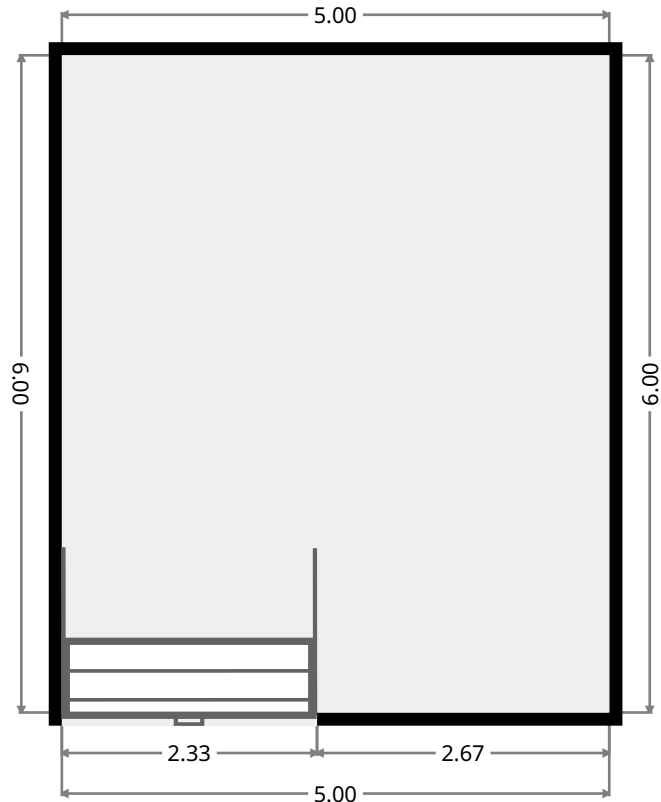
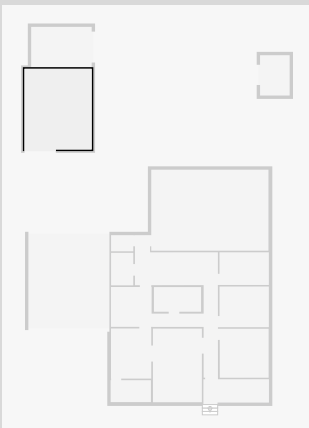

# 6 Bean Street

## Entertainment Area

Width: 6.02 m  
Length: 8.72 m  
Area: 52.48 m<sup>2</sup>  
Perimeter: 29.48 m

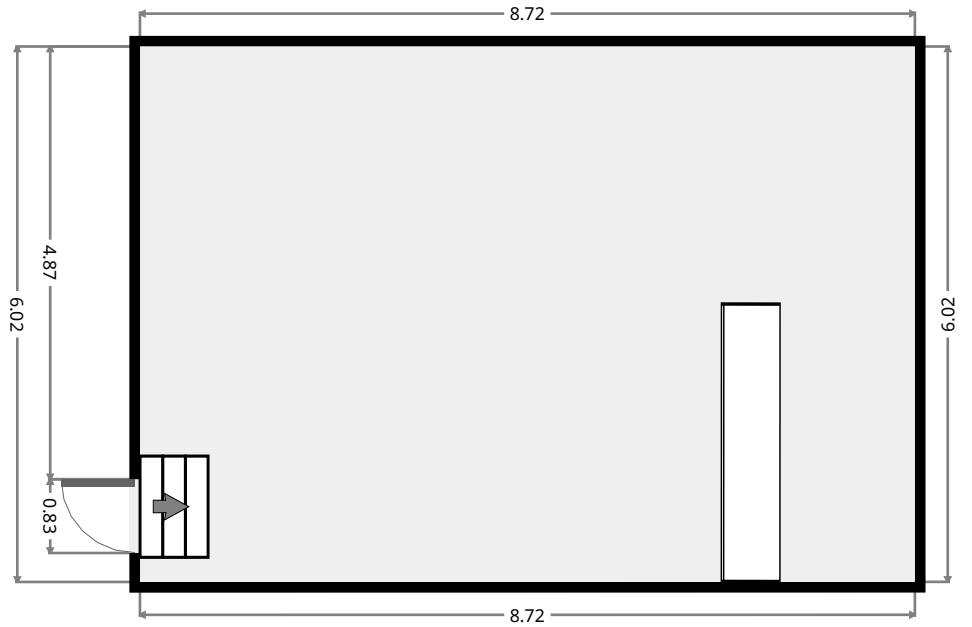
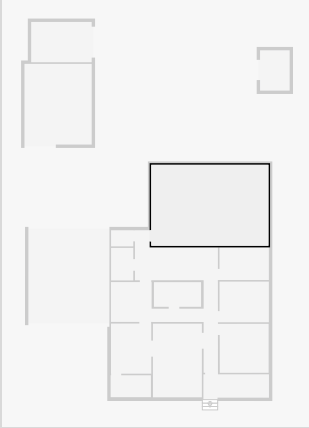

## Carport

Width: 6.02 m  
Length: 6.80 m  
Area: 40.97 m<sup>2</sup>  
Perimeter: 25.65 m

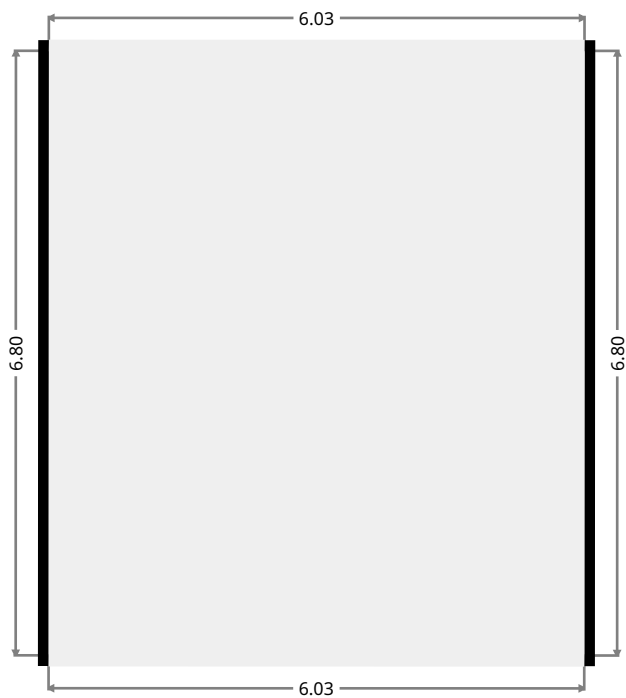
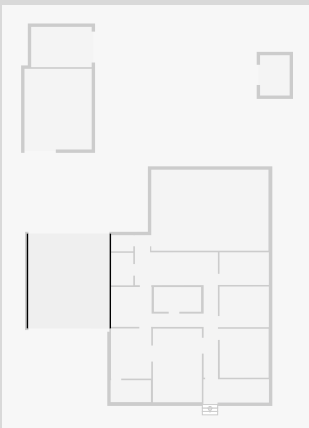

# 6 Bean Street

## Front Verandah

Width: 1.74 m  
Length: 4.87 m  
Area: 8.45 m<sup>2</sup>  
Perimeter: 13.22 m

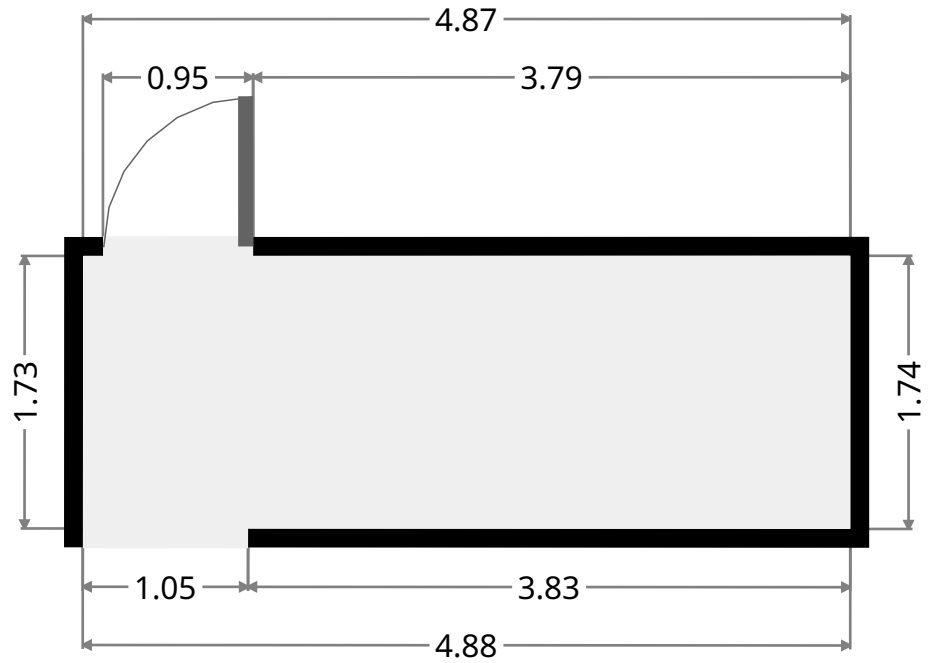
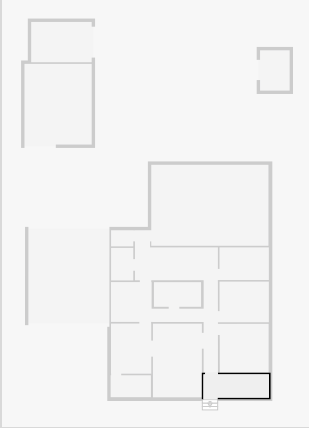

## Toilet

Width: 1.20 m  
Length: 1.65 m  
Area: 1.98 m<sup>2</sup>  
Perimeter: 5.70 m

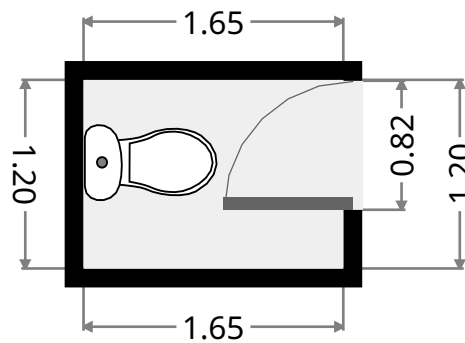
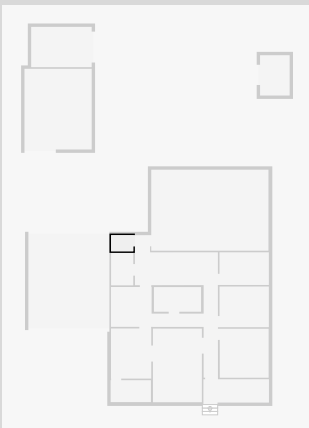

# 6 Bean Street

## Laundry Room

Width: 1.65 m  
 Length: 2.42 m  
 Area: 3.99 m<sup>2</sup>  
 Perimeter: 8.14 m

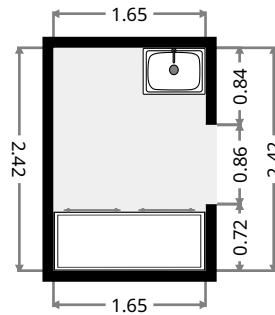
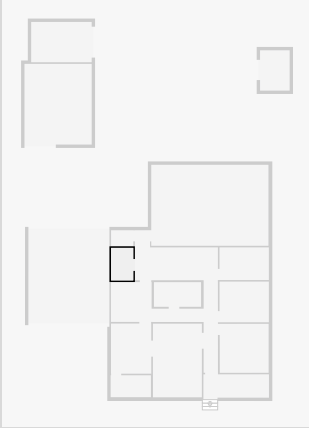

## Hall

Width: 4.87 m  
 Length: 6.78 m  
 Area: 10.96 m<sup>2</sup>  
 Perimeter: 23.28 m

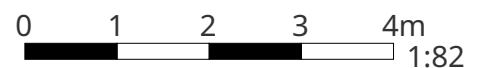
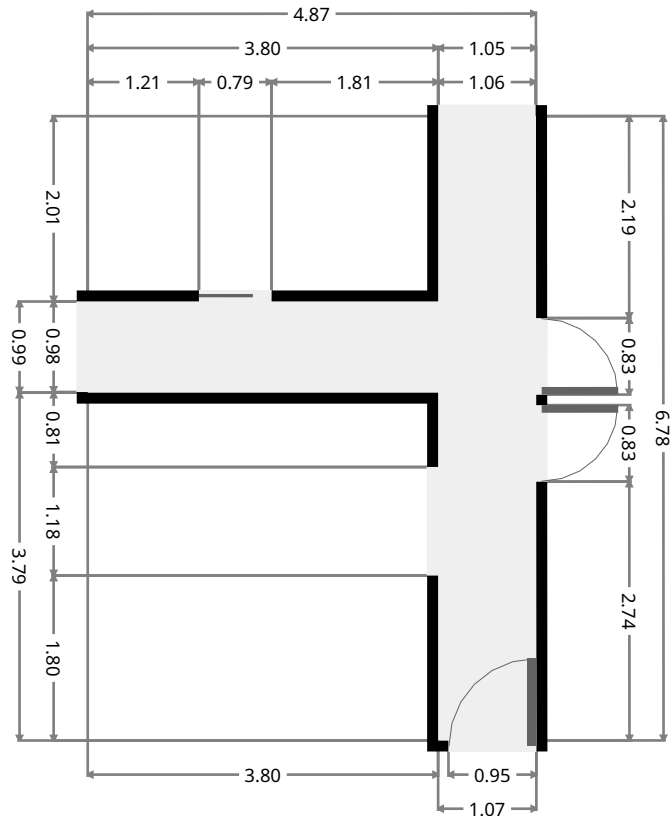
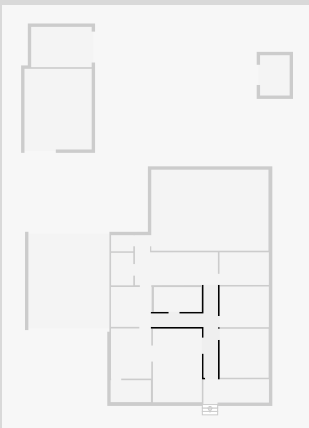

THIS FLOORPLAN IS PROVIDED WITHOUT WARRANTY OF ANY KIND. SENSOPIA DISCLAIMS ANY WARRANTY INCLUDING, WITHOUT LIMITATION, SATISFACTORY QUALITY OR ACCURACY OF DIMENSIONS.

# 6 Bean Street

## Bedroom

Width: 3.03 m  
 Length: 3.67 m  
 Area: 11.09 m<sup>2</sup>  
 Perimeter: 13.38 m

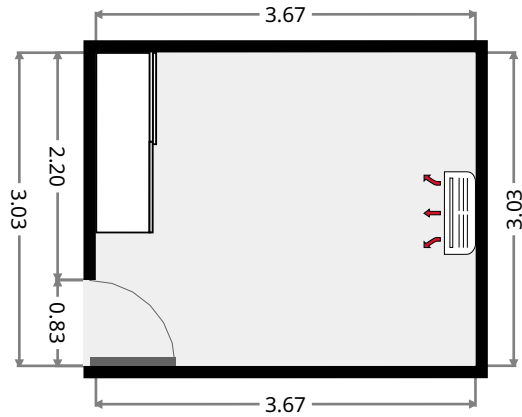
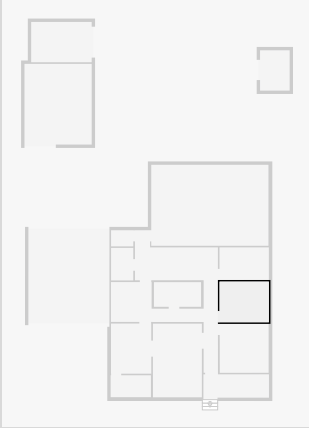

## Living Room

Width: 3.72 m  
 Length: 6.17 m  
 Area: 16.50 m<sup>2</sup>  
 Perimeter: 19.77 m

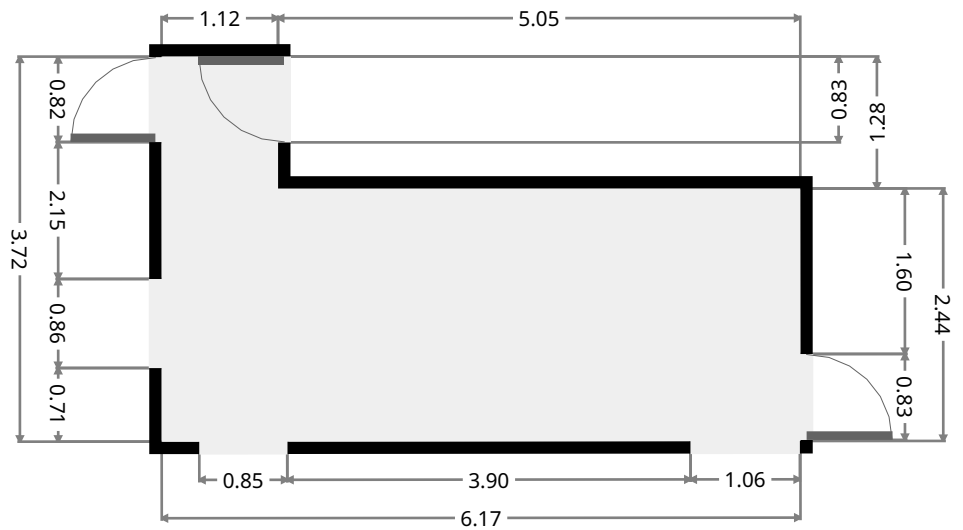
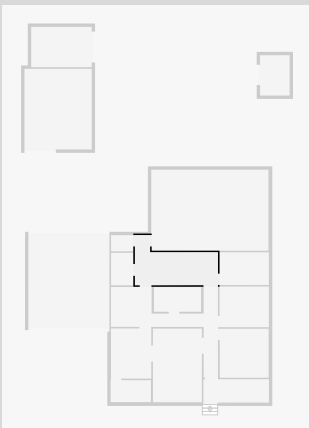

# 6 Bean Street

## Bathroom

Width: 1.83 m  
 Length: 3.51 m  
 Area: 6.43 m<sup>2</sup>  
 Perimeter: 10.68 m

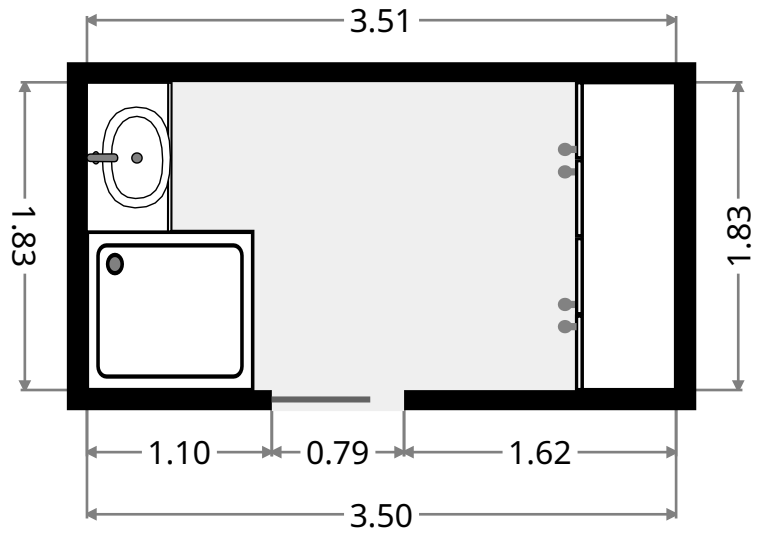
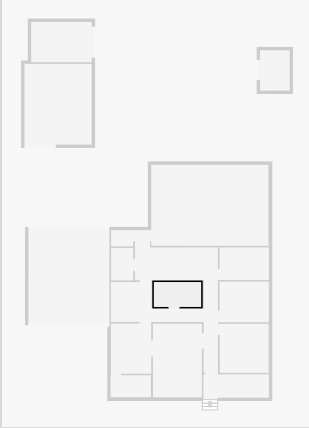

## Kitchen

Width: 2.96 m  
 Length: 3.03 m  
 Area: 8.96 m<sup>2</sup>  
 Perimeter: 11.97 m

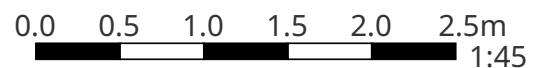
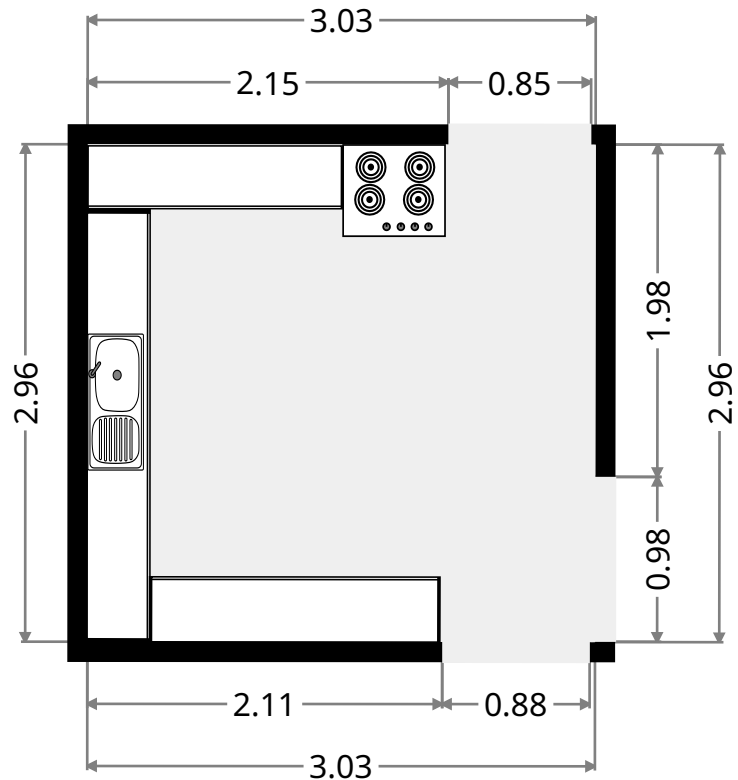
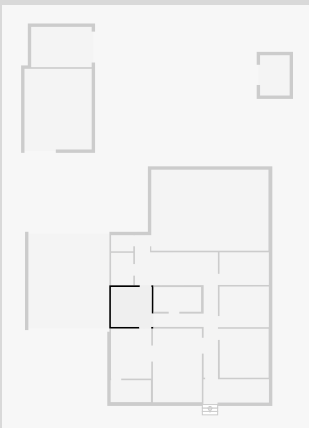

THIS FLOORPLAN IS PROVIDED WITHOUT WARRANTY OF ANY KIND. SENSOPIA DISCLAIMS ANY WARRANTY INCLUDING, WITHOUT LIMITATION, SATISFACTORY QUALITY OR ACCURACY OF DIMENSIONS.



# 6 Bean Street

## Study

Width: 1.63 m  
Length: 2.99 m  
Area: 4.87 m<sup>2</sup>  
Perimeter: 9.24 m

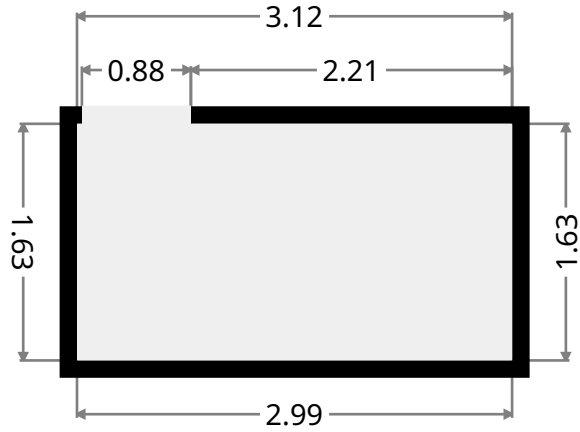
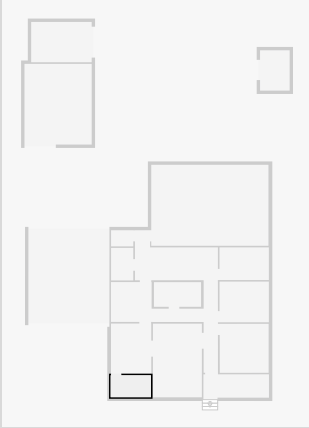

## Dining Room

Width: 2.99 m  
Length: 3.73 m  
Area: 11.16 m<sup>2</sup>  
Perimeter: 13.44 m

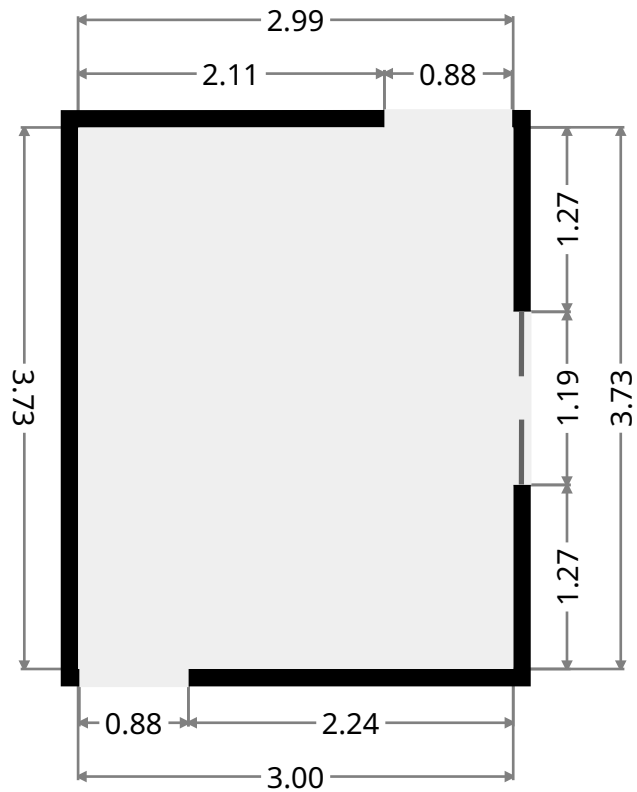
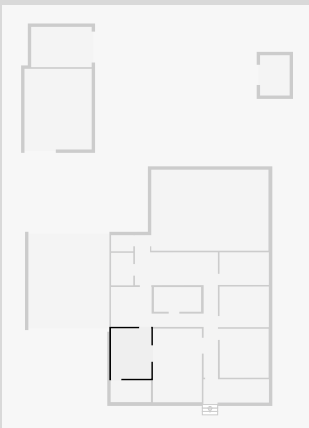

# 6 Bean Street

## Living Room

Width: 3.64 m  
 Length: 5.47 m  
 Area: 19.92 m<sup>2</sup>  
 Perimeter: 18.23 m

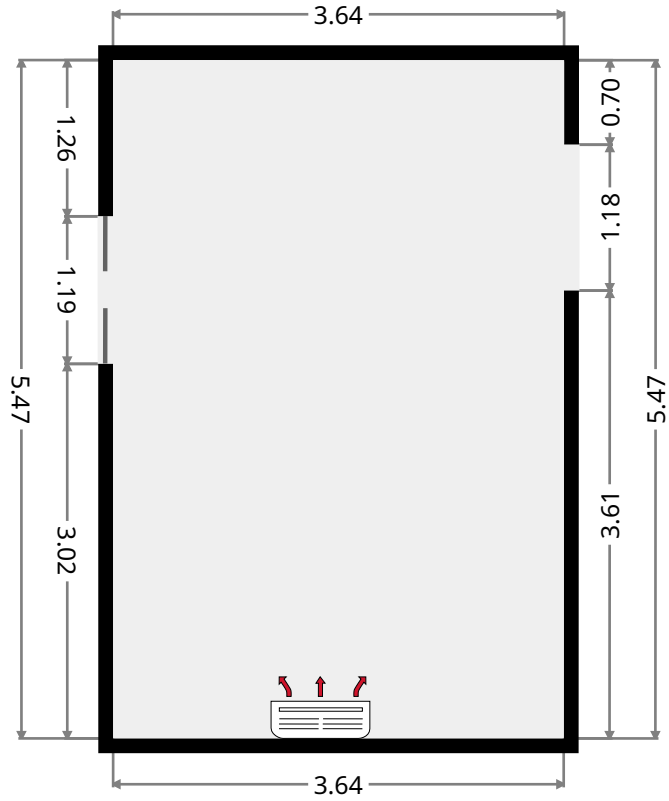
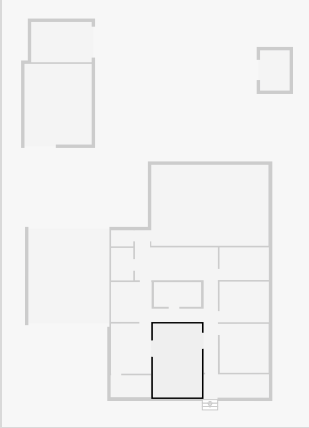

## Master Bedroom

Width: 3.64 m  
 Length: 3.65 m  
 Area: 13.24 m<sup>2</sup>  
 Perimeter: 14.55 m

