

# 6 Bean Avenue

Created on  
2021-05-20

Floors  
2

▼ Ground Floor

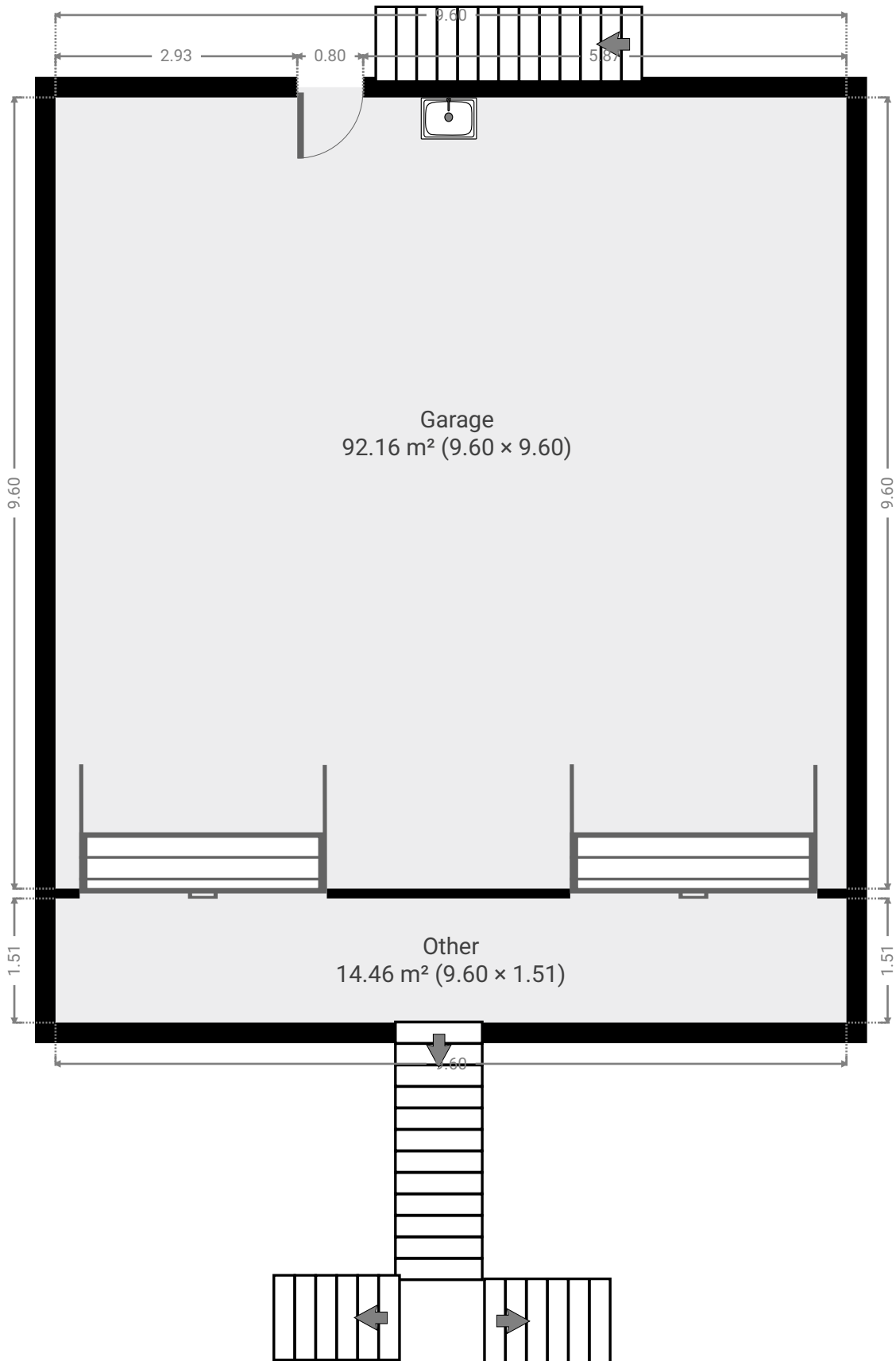

▼ **Garage**  
Ground Floor

WIDTH: 9.60 m • LENGTH: 9.60 m  
AREA: 92.16 m<sup>2</sup> • PERIMETER: 38.40 m

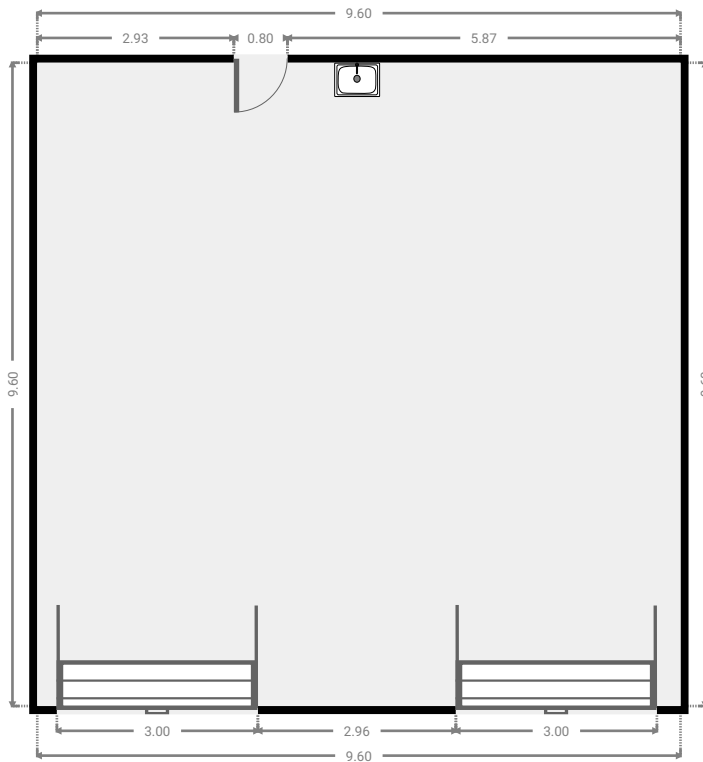
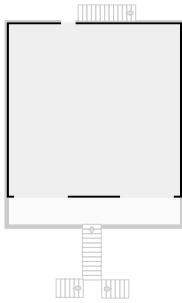

▼ **Other**  
Ground Floor

WIDTH: 9.60 m • LENGTH: 1.51 m  
AREA: 14.46 m<sup>2</sup> • PERIMETER: 22.21 m

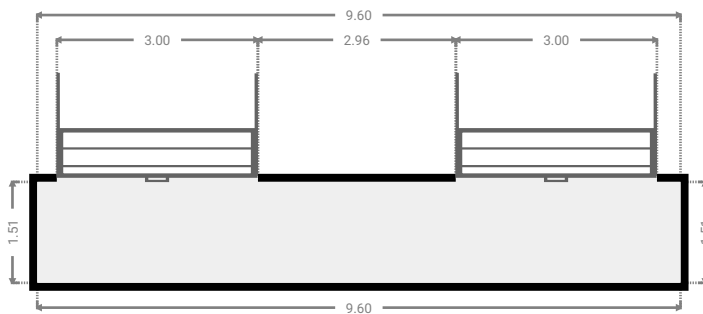
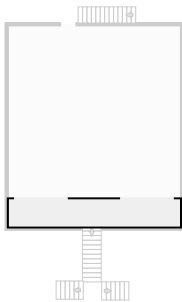

▼ 1st Floor

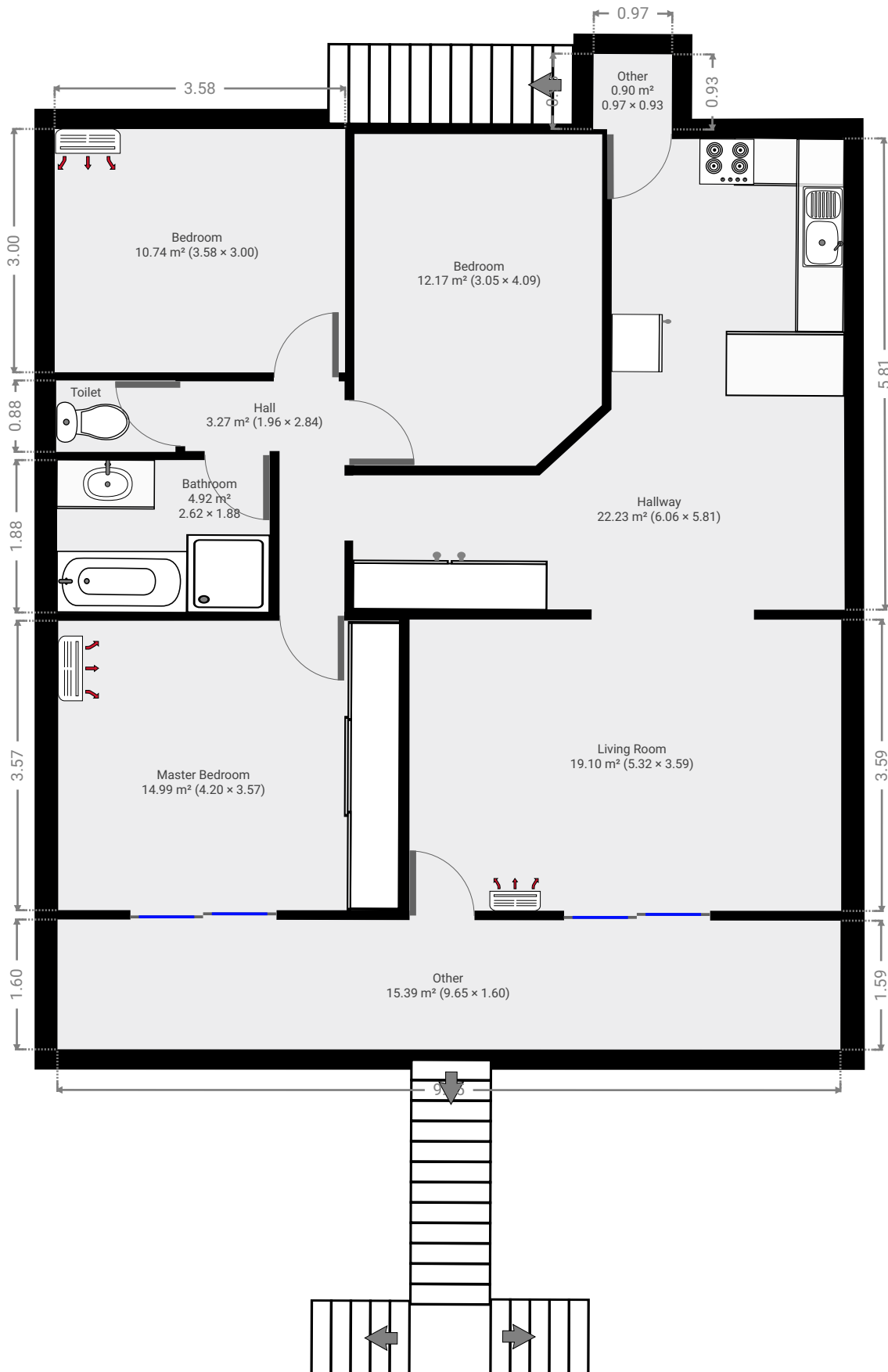

▼ Living Room  
1st Floor

WIDTH: 5.32 m • LENGTH: 3.59 m  
AREA: 19.10 m<sup>2</sup> • PERIMETER: 17.82 m

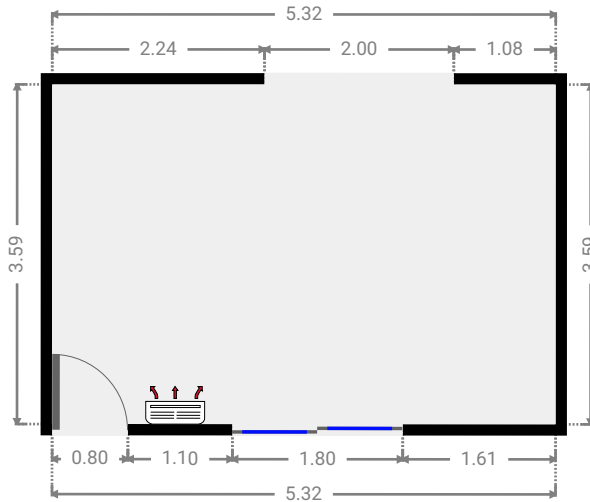
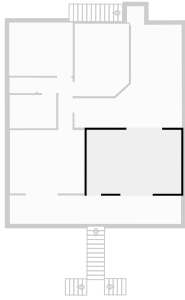

▼ Hallway  
1st Floor

WIDTH: 6.06 m • LENGTH: 5.81 m  
AREA: 22.23 m<sup>2</sup> • PERIMETER: 23.20 m

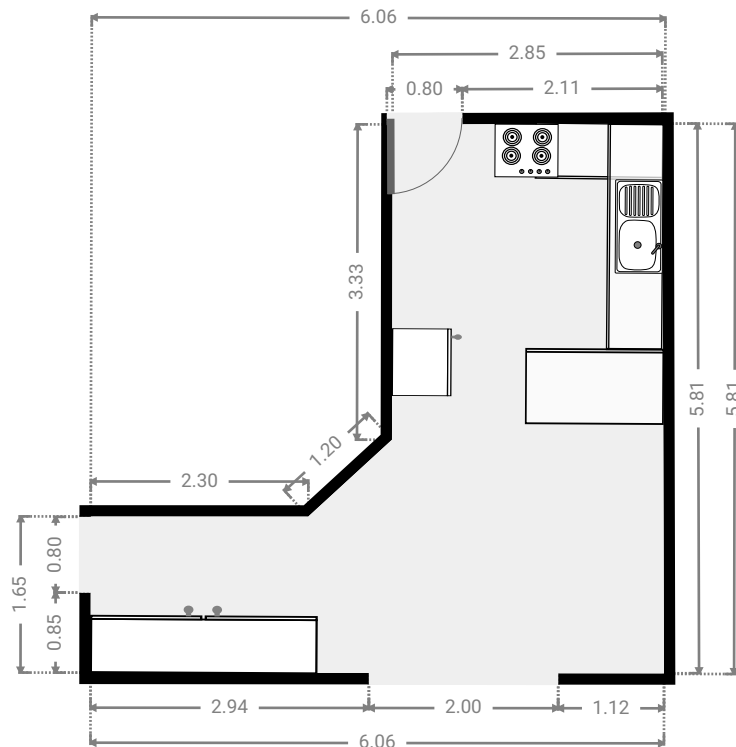
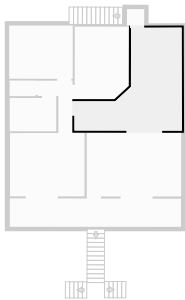

▼ Hall  
1st Floor

WIDTH: 1.96 m • LENGTH: 2.84 m  
AREA: 3.27 m<sup>2</sup> • PERIMETER: 9.61 m

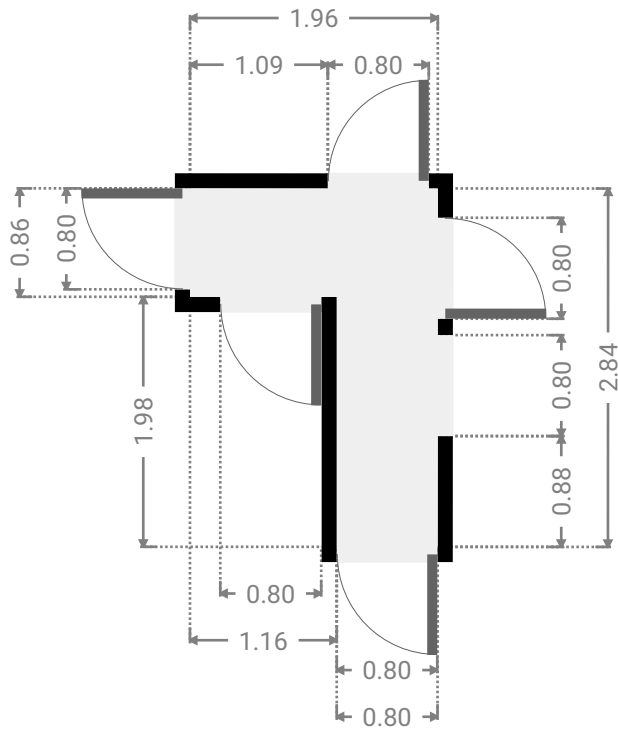
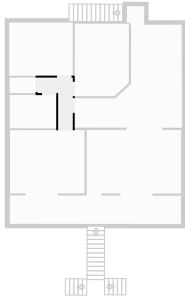

▼ Master Bedroom  
1st Floor

WIDTH: 4.20 m • LENGTH: 3.57 m  
AREA: 14.99 m<sup>2</sup> • PERIMETER: 15.54 m

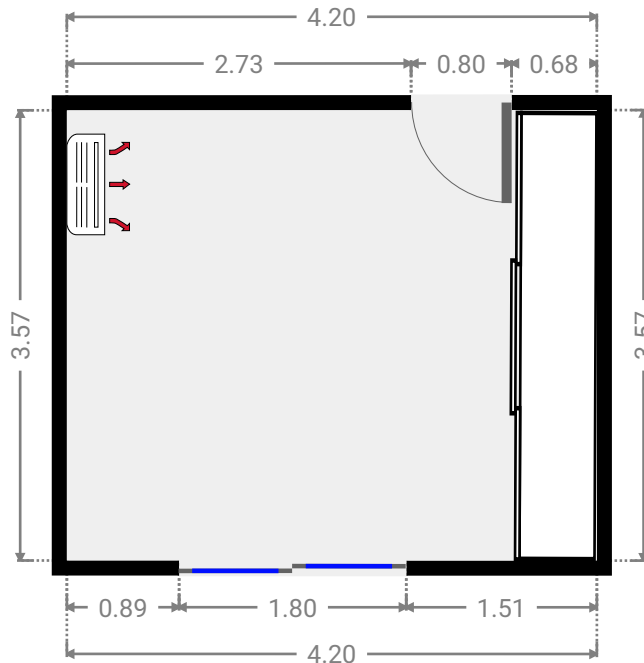
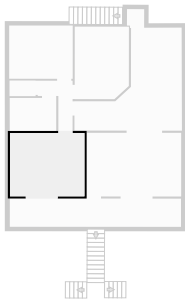

▼ **Bedroom**  
1st Floor

WIDTH: 3.05 m • LENGTH: 4.09 m  
AREA: 12.17 m<sup>2</sup> • PERIMETER: 13.82 m

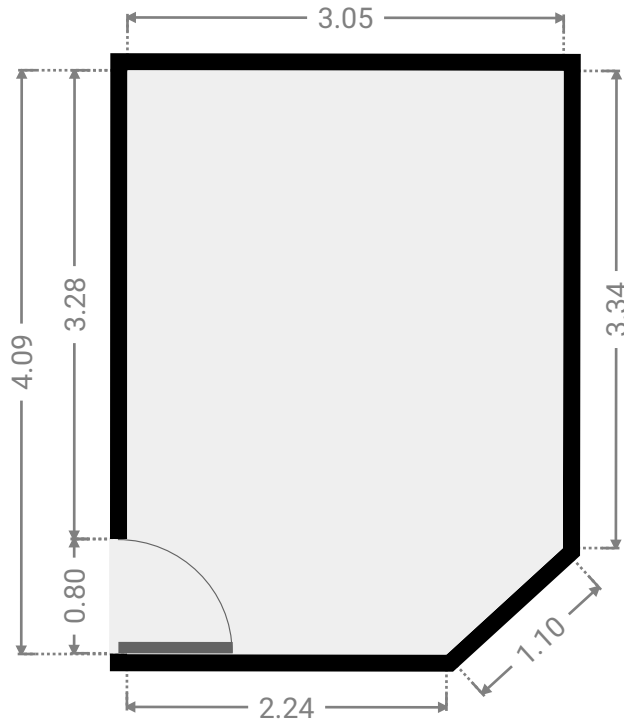
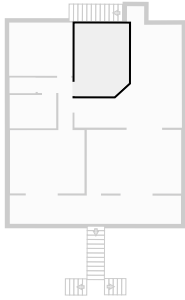

▼ **Bedroom**  
1st Floor

WIDTH: 3.58 m • LENGTH: 3.00 m  
AREA: 10.74 m<sup>2</sup> • PERIMETER: 13.16 m

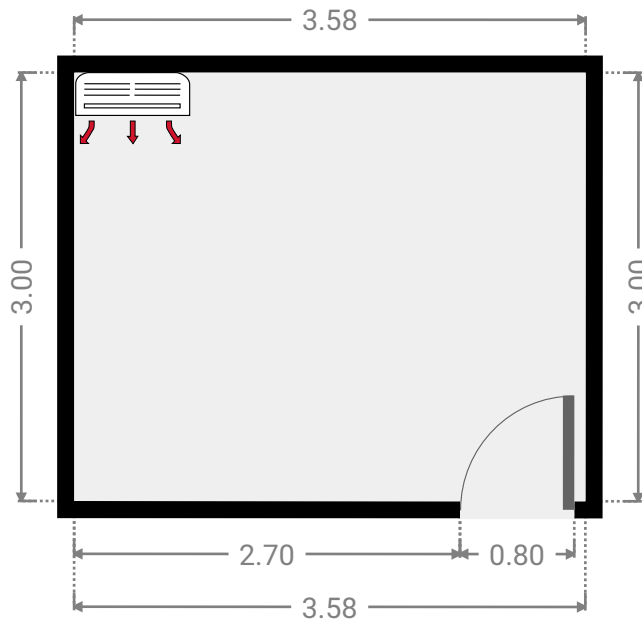
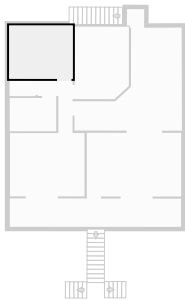

▼ **Toilet**  
1st Floor

WIDTH: 1.47 m • LENGTH: 0.88 m  
AREA: 1.29 m<sup>2</sup> • PERIMETER: 4.70 m

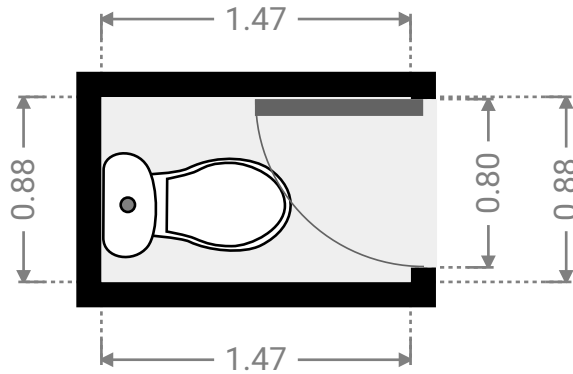
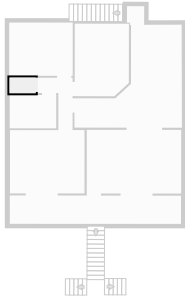

▼ **Bathroom**  
1st Floor

WIDTH: 2.62 m • LENGTH: 1.88 m  
AREA: 4.92 m<sup>2</sup> • PERIMETER: 9.00 m

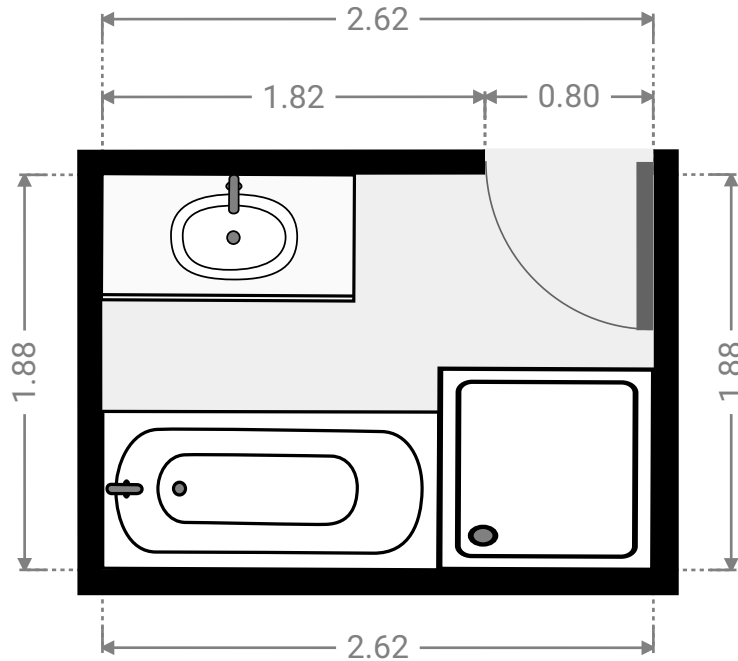
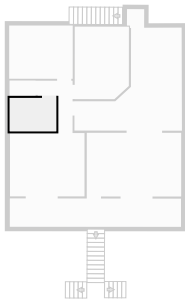



▼ Other  
1st Floor

WIDTH: 9.65 m • LENGTH: 1.60 m  
AREA: 15.39 m<sup>2</sup> • PERIMETER: 22.49 m

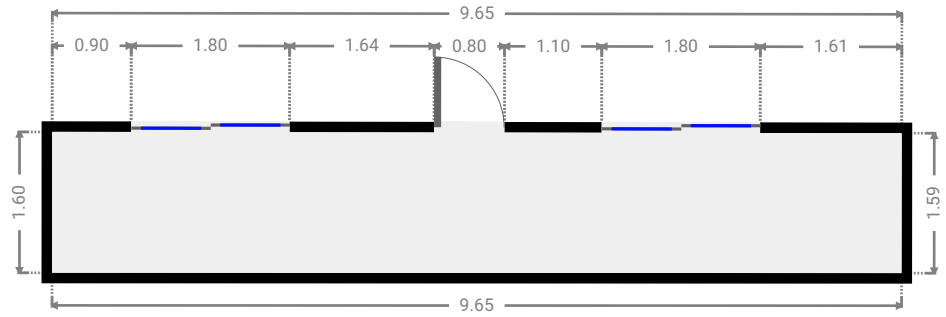

▼ Other  
1st Floor

WIDTH: 0.97 m • LENGTH: 0.93 m  
AREA: 0.90 m<sup>2</sup> • PERIMETER: 3.79 m

