

58 Twigg Street

SUBMITTED BY
Janelle Casey

CREATED ON
2021-10-19

Floors 1

▼ Ground Floor



THIS FLOORPLAN IS PROVIDED WITHOUT WARRANTY OF ANY KIND. SENSOPIA DISCLAIMS ANY WARRANTY INCLUDING, WITHOUT LIMITATION, SATISFACTORY QUALITY OR ACCURACY OF DIMENSIONS.



▼ **Bedroom**
Ground Floor

WIDTH: 3.69 m • LENGTH: 3.28 m
AREA: 11.37 m² • PERIMETER: 13.93 m

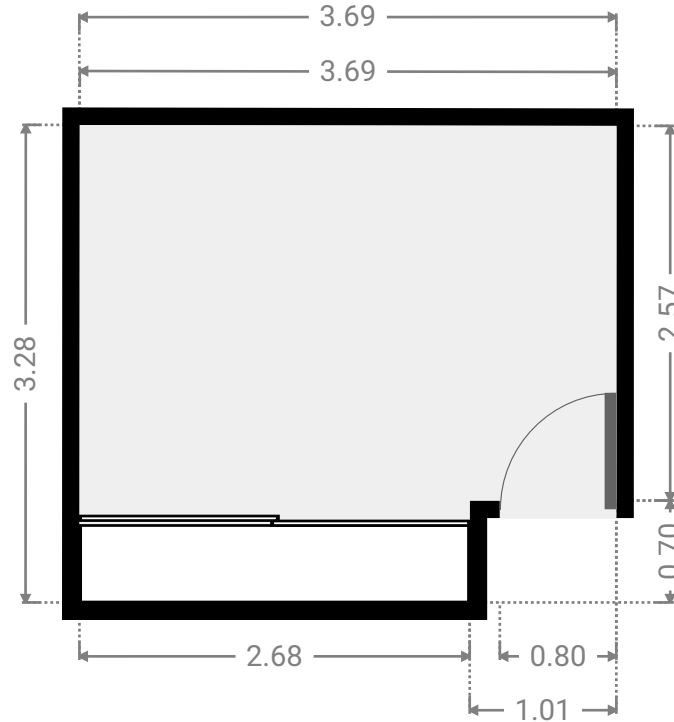
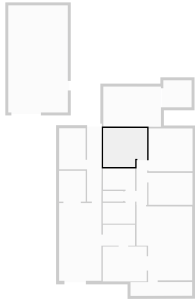

▼ **Other**
Ground Floor

WIDTH: 5.18 m • LENGTH: 1.16 m
AREA: 5.97 m² • PERIMETER: 12.67 m

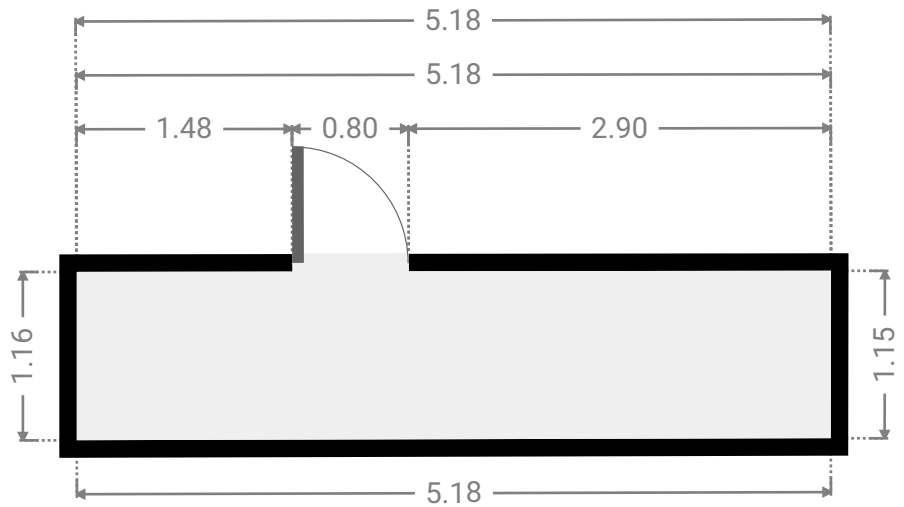

FLOORS: 1

▼ Carport
Ground Floor

WIDTH: 5.00 m • LENGTH: 9.00 m
AREA: 45.00 m² • PERIMETER: 28.00 m

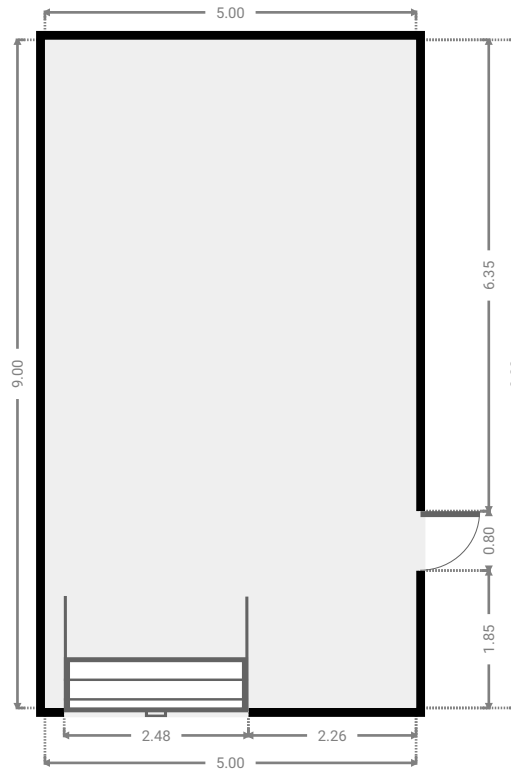
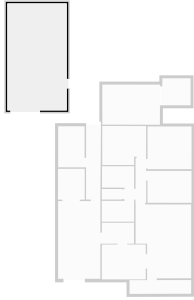

▼ Other
Ground Floor

WIDTH: 2.37 m • LENGTH: 2.27 m
AREA: 5.38 m² • PERIMETER: 9.28 m

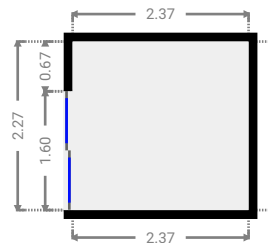
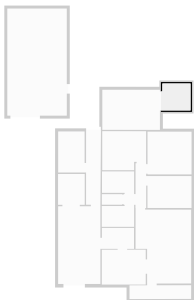

▼ Entertainment Area Ground Floor

WIDTH: 4.84 m • LENGTH: 3.37 m
AREA: 16.31 m² • PERIMETER: 16.42 m

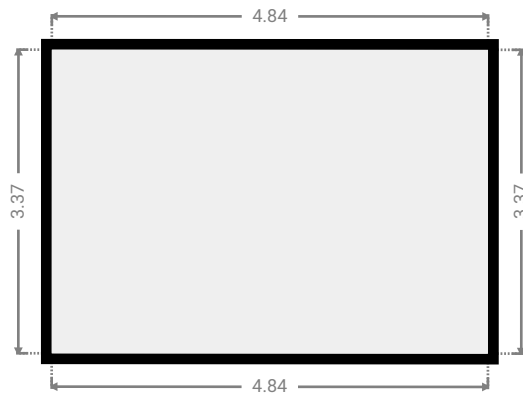
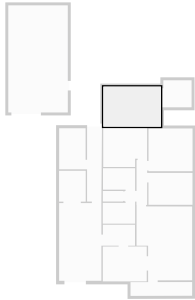

▼ Hall Ground Floor

WIDTH: 1.25 m • LENGTH: 6.18 m
AREA: 7.56 m² • PERIMETER: 14.80 m

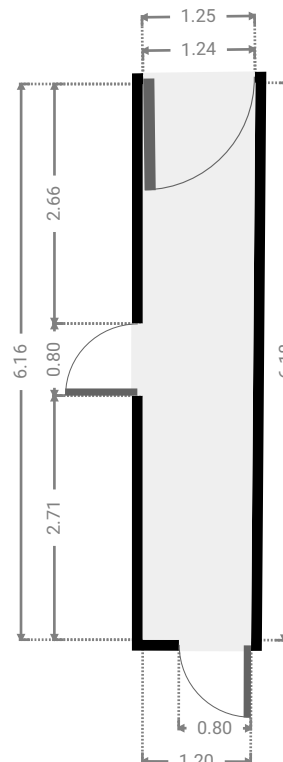
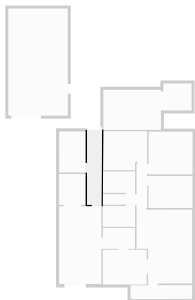

▼ **Bedroom**
Ground Floor

WIDTH: 2.22 m • LENGTH: 3.45 m
AREA: 7.66 m² • PERIMETER: 11.34 m

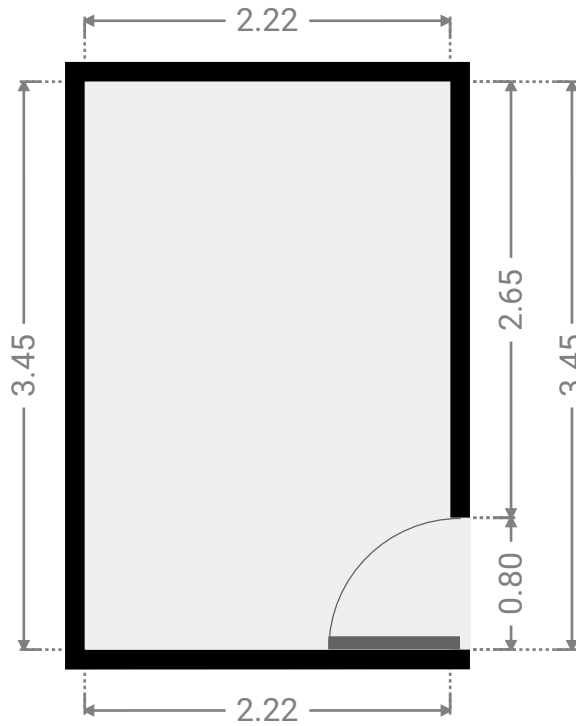
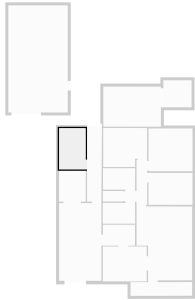

▼ **Other**
Ground Floor

WIDTH: 2.24 m • LENGTH: 2.59 m
AREA: 5.80 m² • PERIMETER: 9.66 m

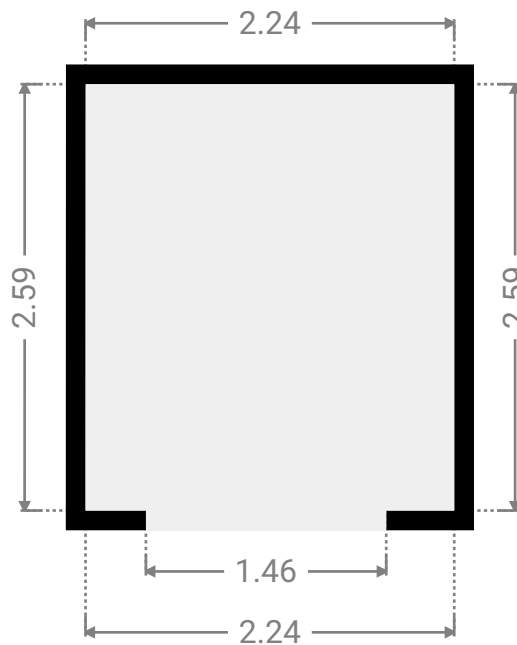
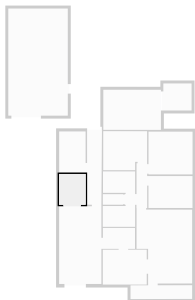

▼ **Living Room**
Ground Floor

WIDTH: 3.55 m • LENGTH: 6.53 m
AREA: 23.18 m² • PERIMETER: 20.16 m

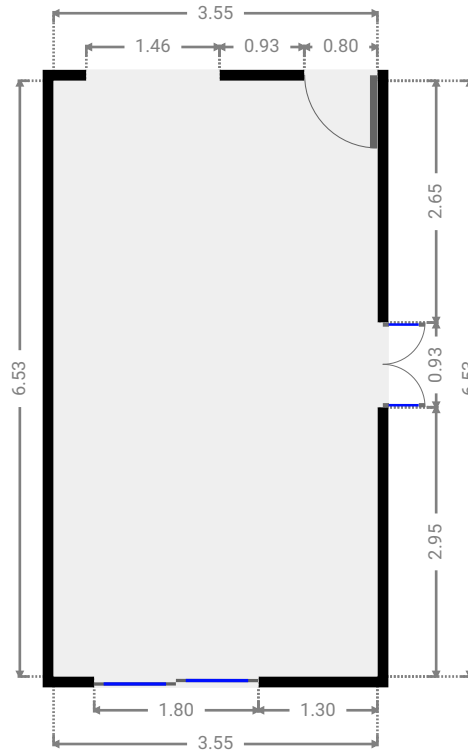

▼ **Living Room**
Ground Floor

WIDTH: 4.68 m • LENGTH: 6.22 m
AREA: 26.18 m² • PERIMETER: 21.76 m

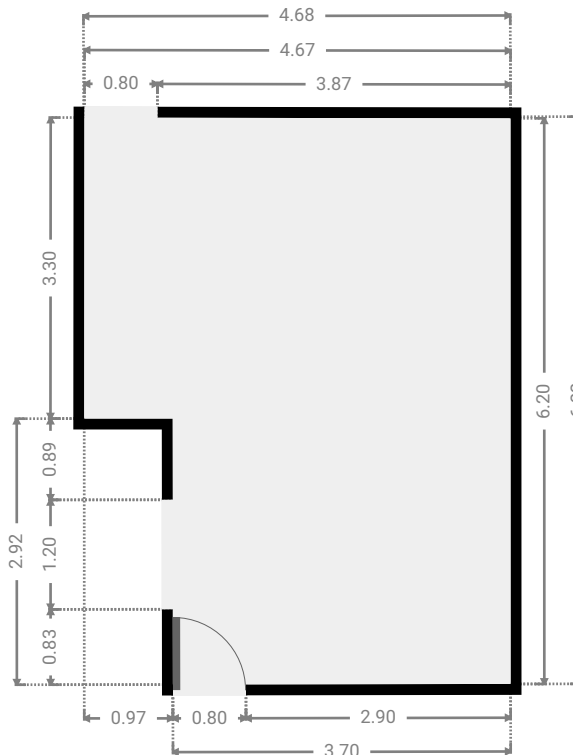

▼ **Bedroom**
Ground Floor

WIDTH: 3.70 m • LENGTH: 3.59 m
AREA: 13.29 m² • PERIMETER: 14.58 m

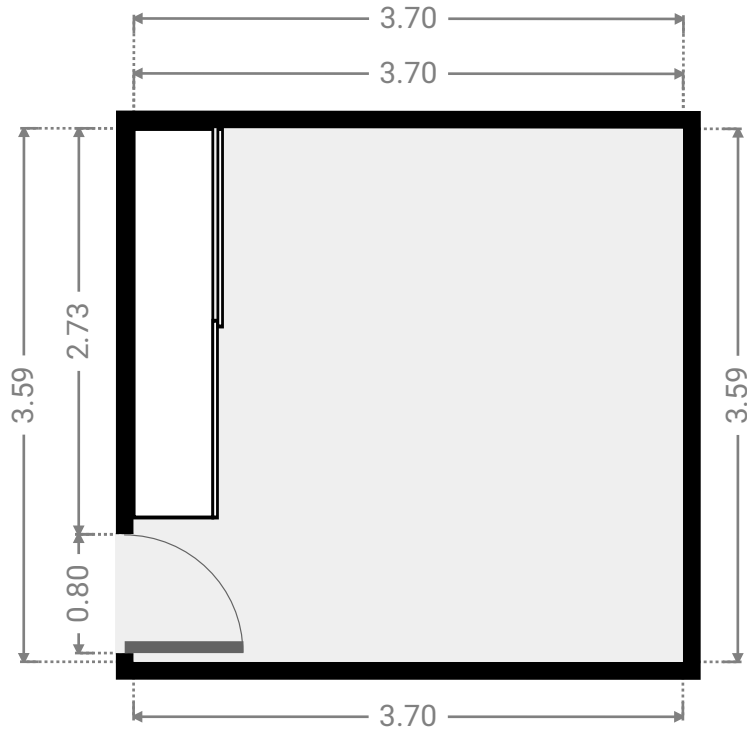
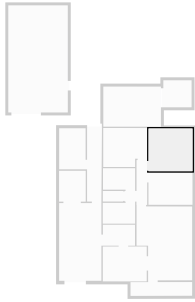

▼ **Bedroom**
Ground Floor

WIDTH: 3.70 m • LENGTH: 2.68 m
AREA: 9.92 m² • PERIMETER: 12.76 m

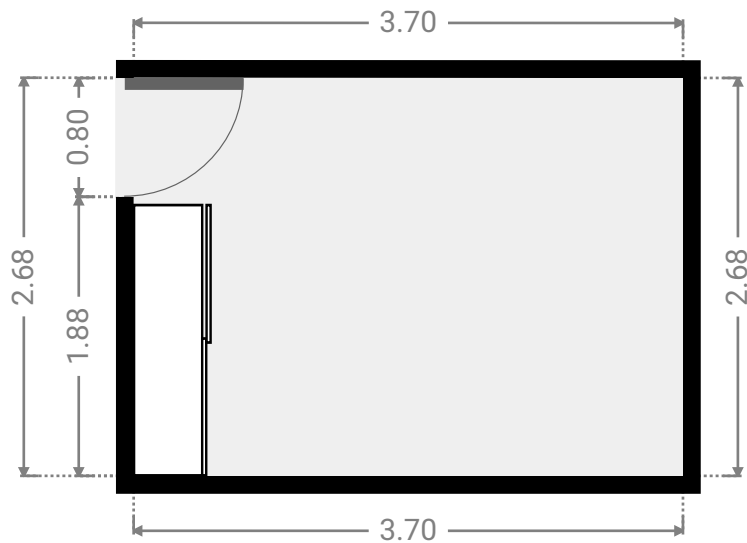
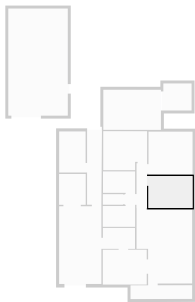

▼ **Bathroom**
Ground Floor

WIDTH: 2.70 m • LENGTH: 1.80 m
AREA: 4.86 m² • PERIMETER: 9.00 m

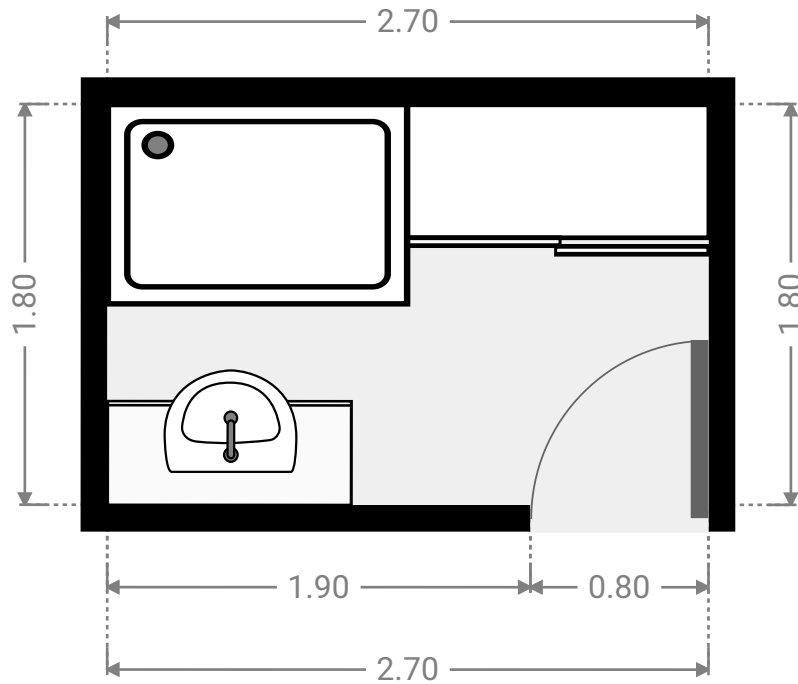
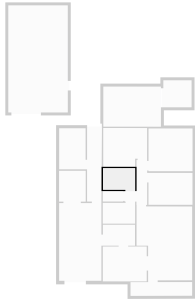

▼ **Toilet**
Ground Floor

WIDTH: 1.71 m • LENGTH: 0.89 m
AREA: 1.51 m² • PERIMETER: 5.20 m

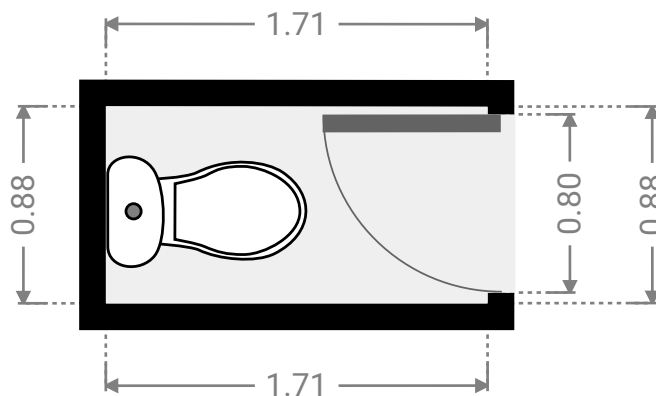

▼ **Study**
Ground Floor

WIDTH: 2.72 m • LENGTH: 1.75 m
AREA: 4.76 m² • PERIMETER: 8.94 m

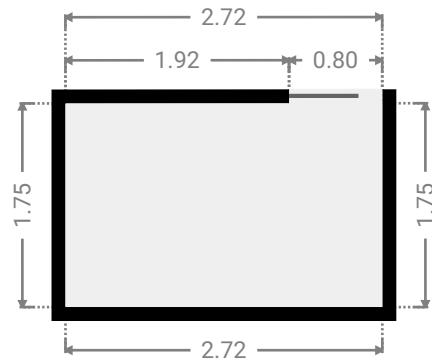

▼ **Hall**
Ground Floor

WIDTH: 1.89 m • LENGTH: 3.77 m
AREA: 4.27 m² • PERIMETER: 11.32 m

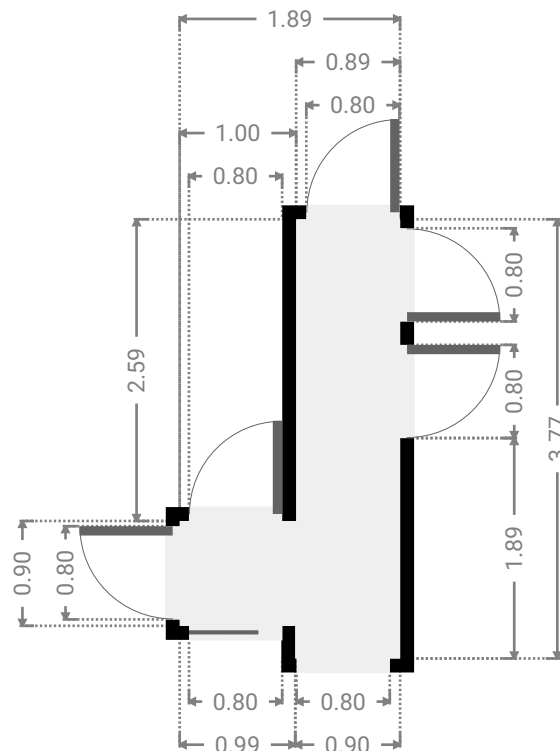

▼ Laundry Room
Ground Floor

WIDTH: 2.70 m • LENGTH: 1.76 m
AREA: 4.75 m² • PERIMETER: 8.92 m

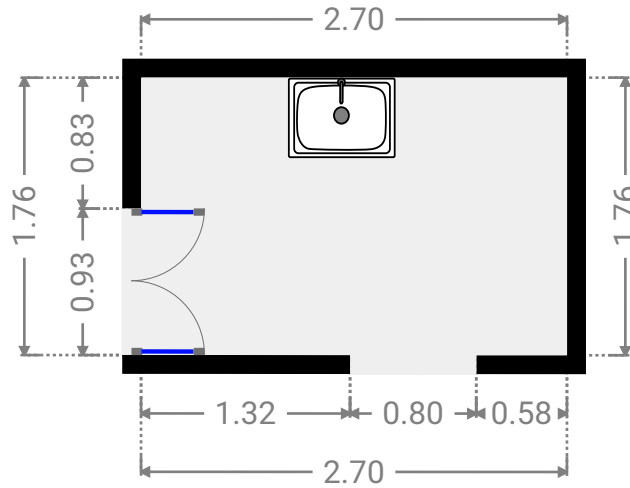

▼ Kitchen
Ground Floor

WIDTH: 3.69 m • LENGTH: 2.93 m
AREA: 10.80 m² • PERIMETER: 13.23 m

