

57 Macfarlane Street

Ground Floor

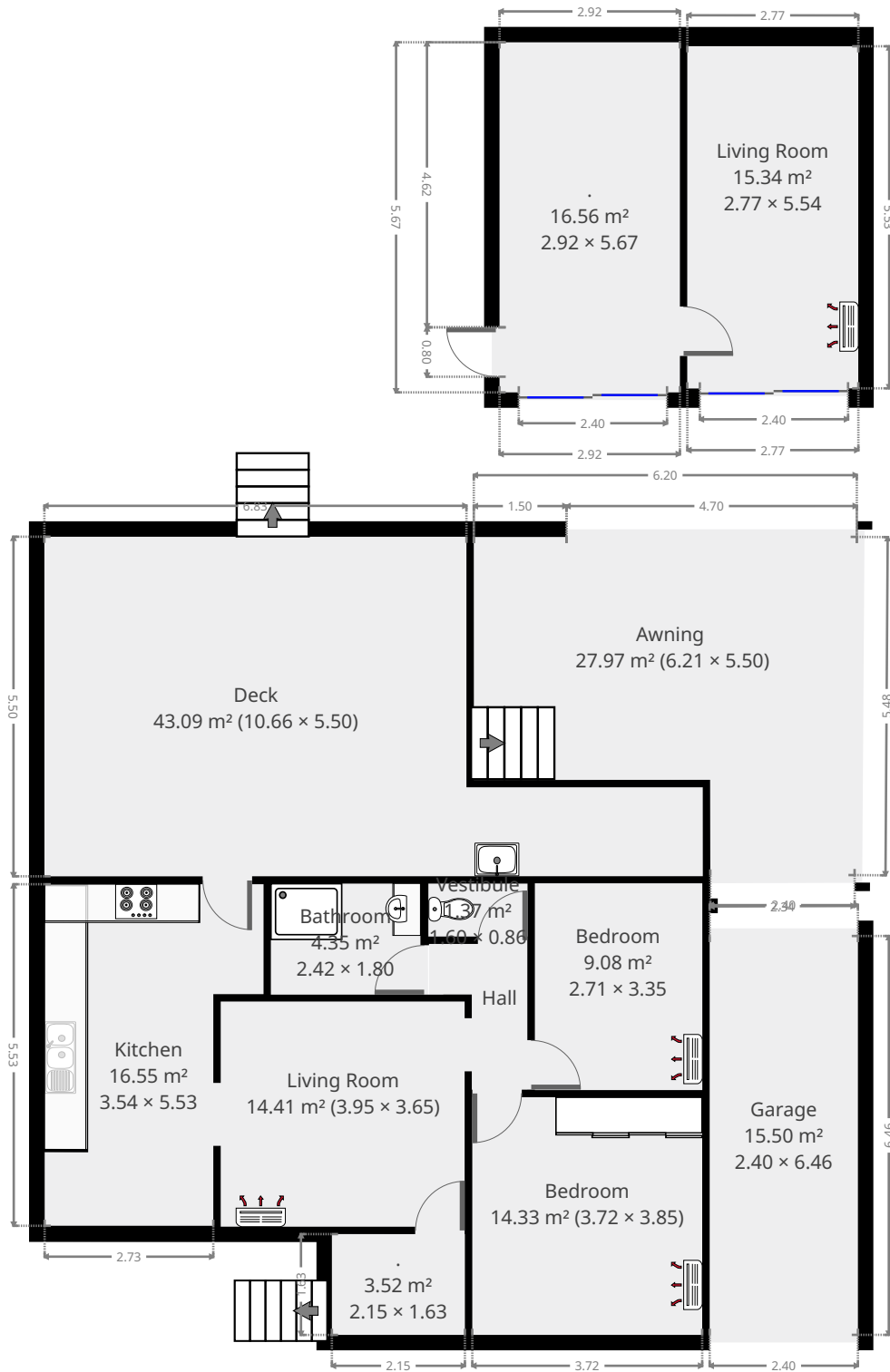

THIS FLOORPLAN IS PROVIDED WITHOUT WARRANTY OF ANY KIND. SENSOPIA DISCLAIMS ANY WARRANTY INCLUDING, WITHOUT LIMITATION, SATISFACTORY QUALITY OR ACCURACY OF DIMENSIONS.



57 Macfarlane Street

Living Room

Width: 3.65 m
 Length: 3.95 m
 Area: 14.41 m²
 Perimeter: 15.19 m

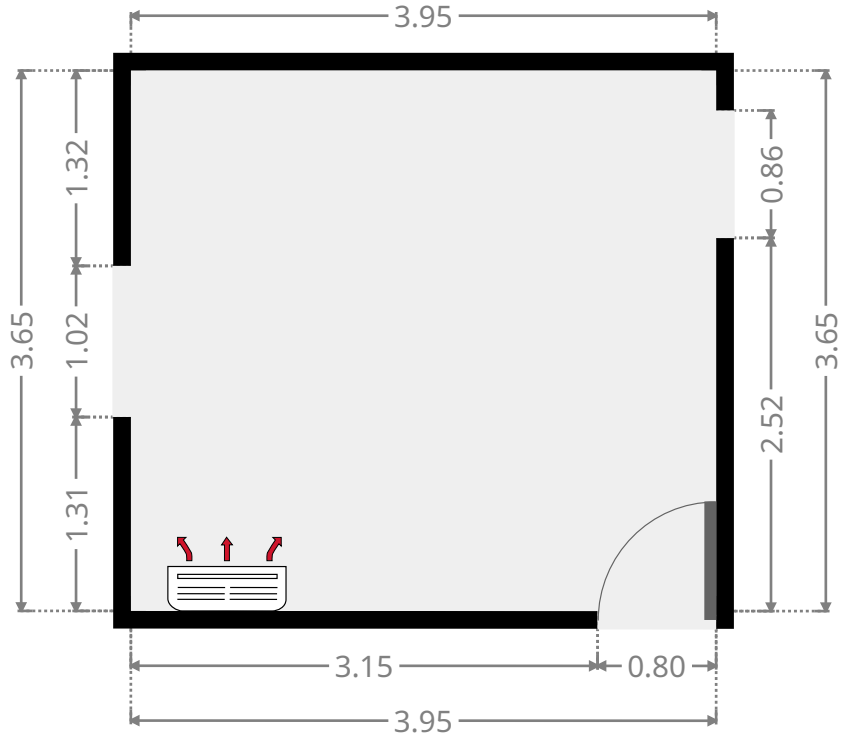
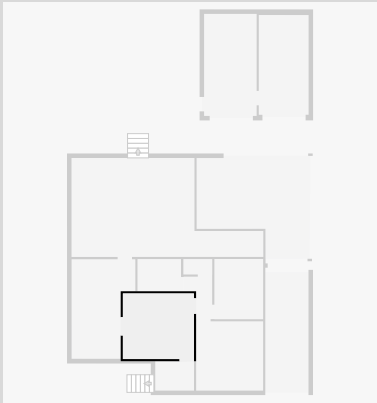

Hall

Width: 1.59 m
 Length: 2.36 m
 Area: 2.69 m²
 Perimeter: 7.90 m

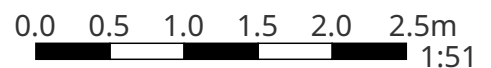
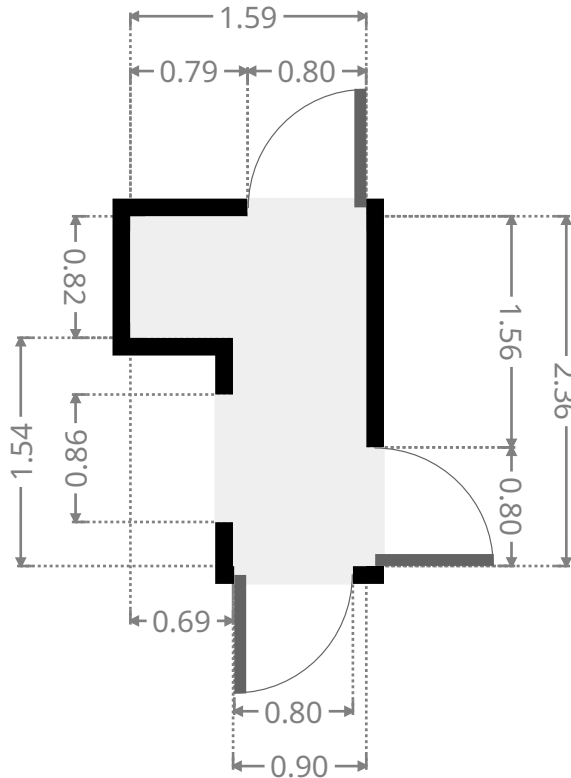
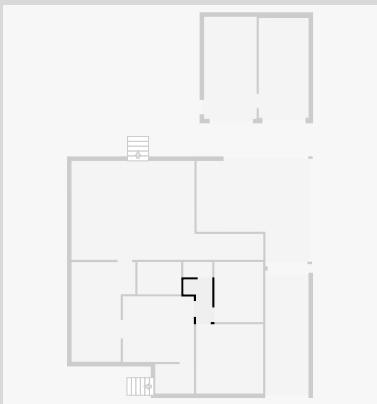

57 Macfarlane Street

Bedroom

Width: 3.72 m
Length: 3.85 m
Area: 14.33 m²
Perimeter: 15.14 m

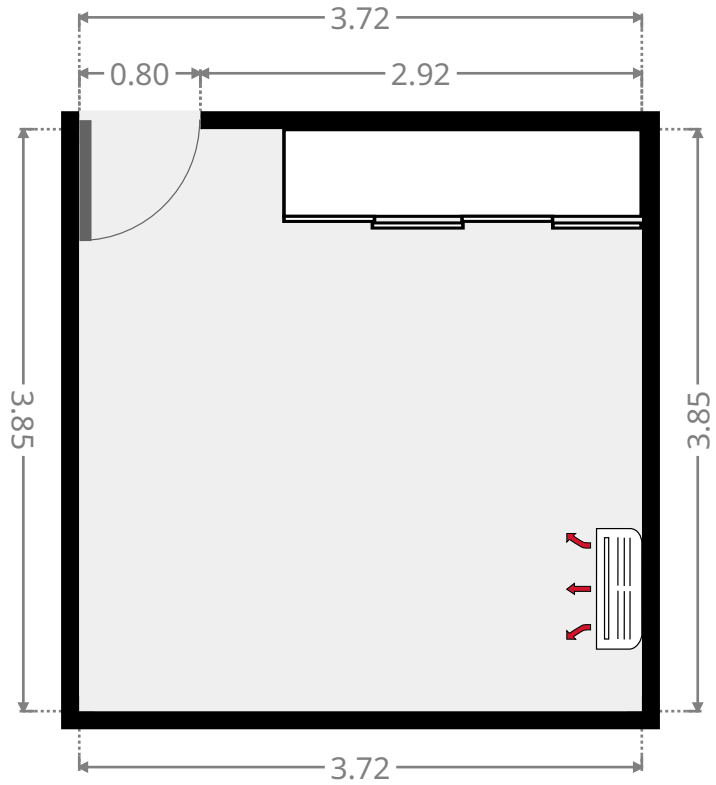
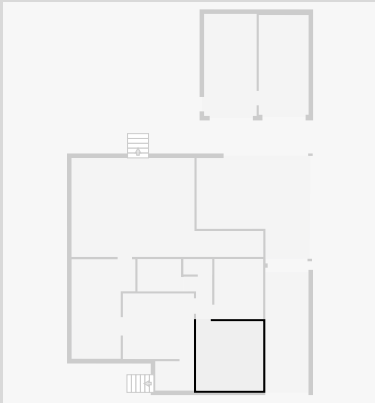

Bedroom

Width: 2.71 m
Length: 3.35 m
Area: 9.08 m²
Perimeter: 12.12 m

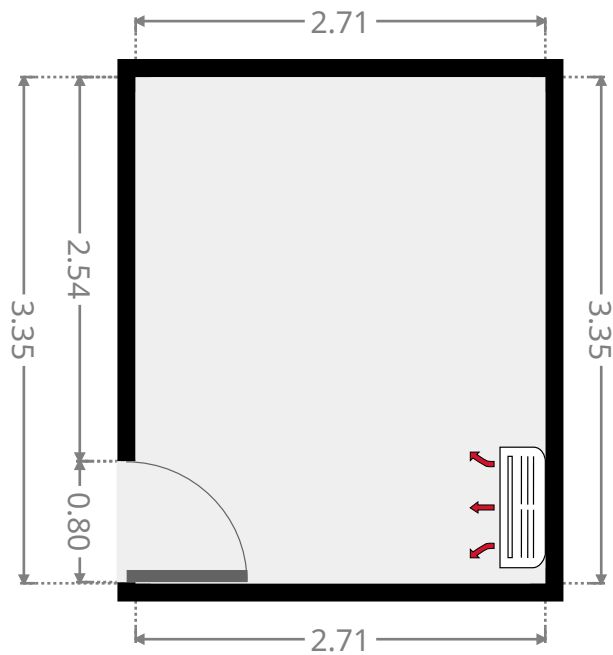
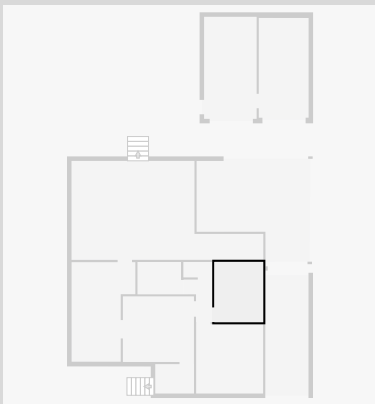

57 Macfarlane Street

Vestibule

Width: 0.86 m
Length: 1.60 m
Area: 1.37 m²
Perimeter: 4.92 m

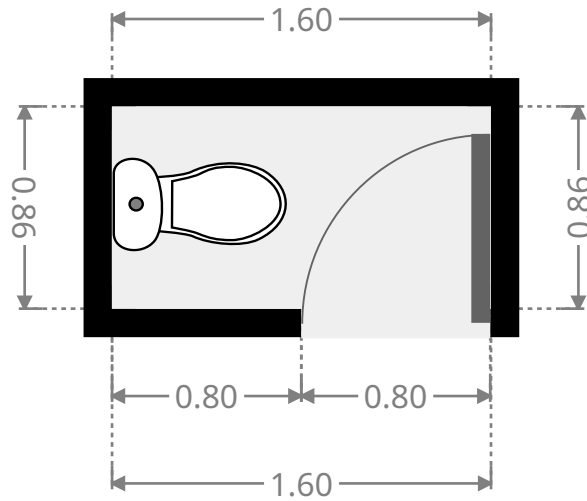
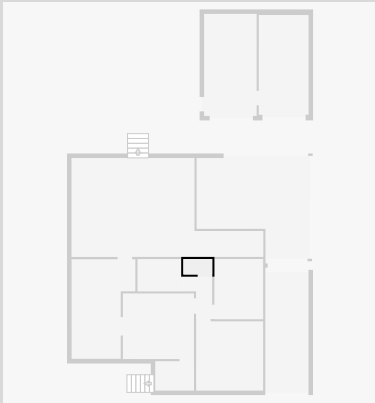

Bathroom

Width: 1.80 m
Length: 2.42 m
Area: 4.35 m²
Perimeter: 8.44 m

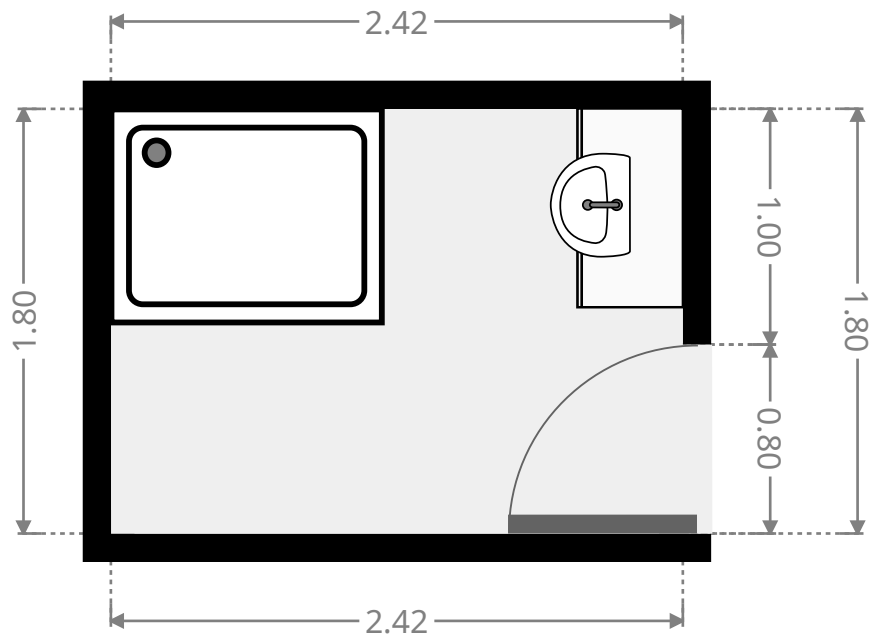
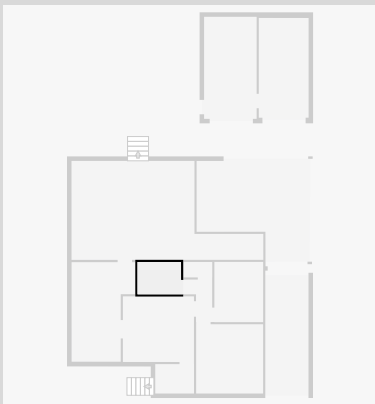

57 Macfarlane Street

Kitchen

Width: 3.54 m
 Length: 5.53 m
 Area: 16.55 m²
 Perimeter: 18.15 m

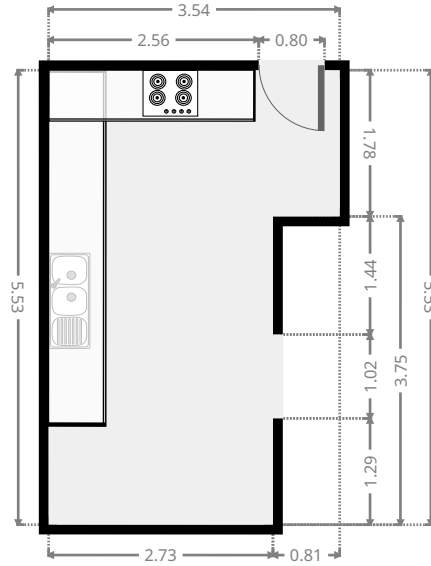
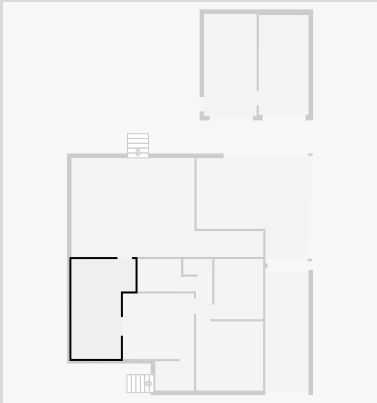

Deck

Width: 5.50 m
 Length: 10.66 m
 Area: 43.09 m²
 Perimeter: 32.32 m

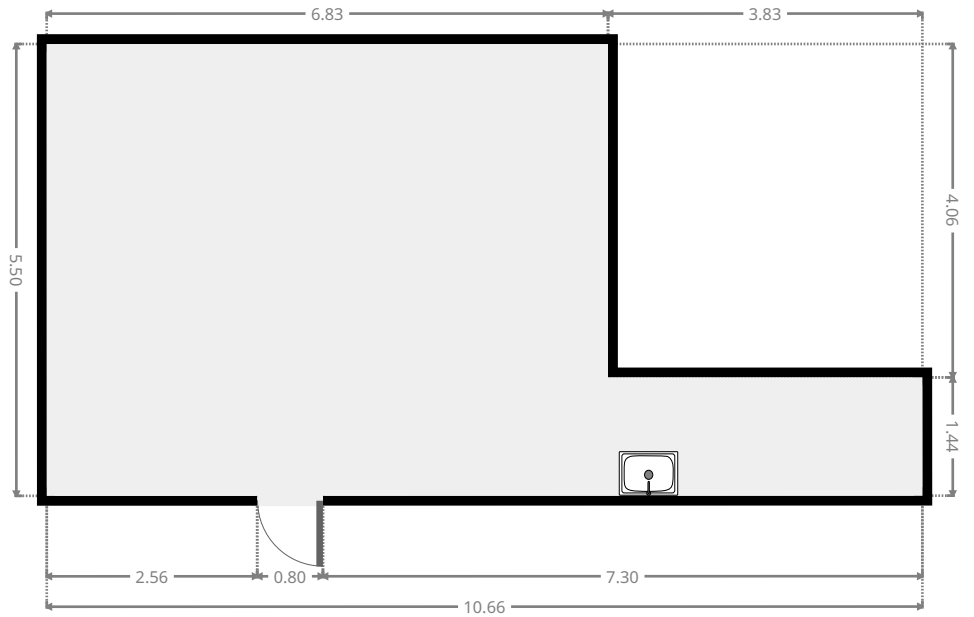
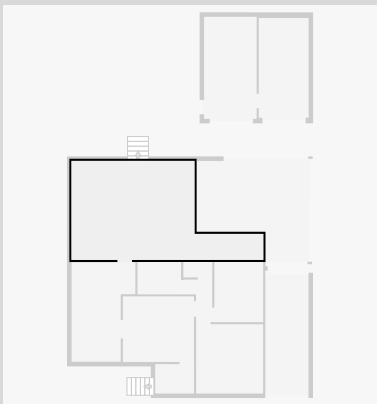

THIS FLOORPLAN IS PROVIDED WITHOUT WARRANTY OF ANY KIND. SENSOPIA DISCLAIMS ANY WARRANTY INCLUDING, WITHOUT LIMITATION, SATISFACTORY QUALITY OR ACCURACY OF DIMENSIONS.



57 Macfarlane Street

Garage

Width: 2.40 m
Length: 6.46 m
Area: 15.50 m²
Perimeter: 17.72 m

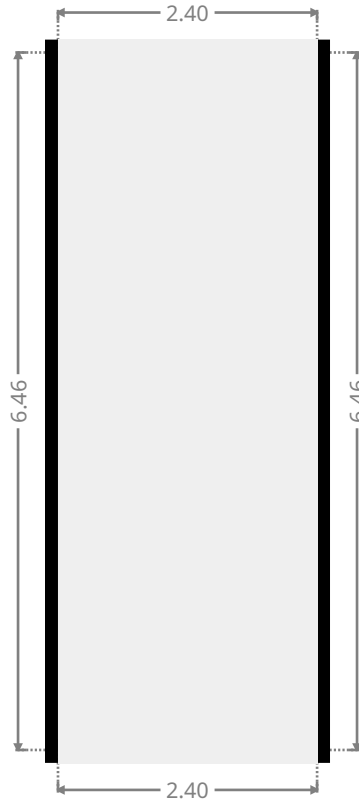
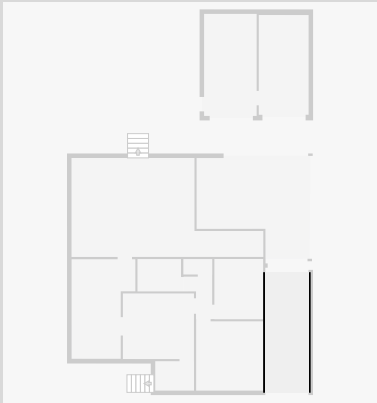

•
Width: 2.92 m
Length: 5.67 m
Area: 16.56 m²
Perimeter: 17.18 m

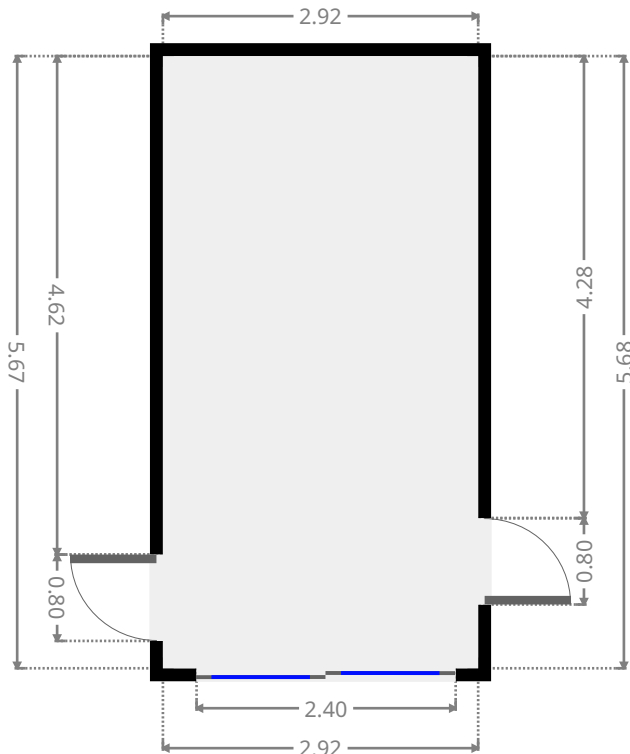
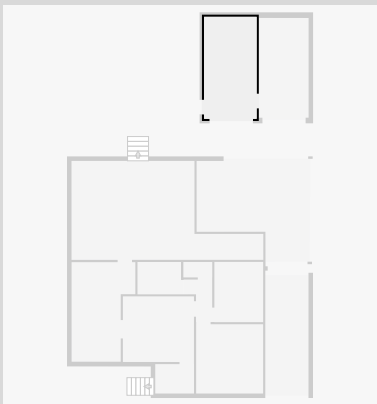

THIS FLOORPLAN IS PROVIDED WITHOUT WARRANTY OF ANY KIND. SENSOPIA DISCLAIMS ANY WARRANTY INCLUDING, WITHOUT LIMITATION, SATISFACTORY QUALITY OR ACCURACY OF DIMENSIONS.



57 Macfarlane Street

Living Room

Width: 2.77 m
 Length: 5.54 m
 Area: 15.34 m²
 Perimeter: 16.62 m

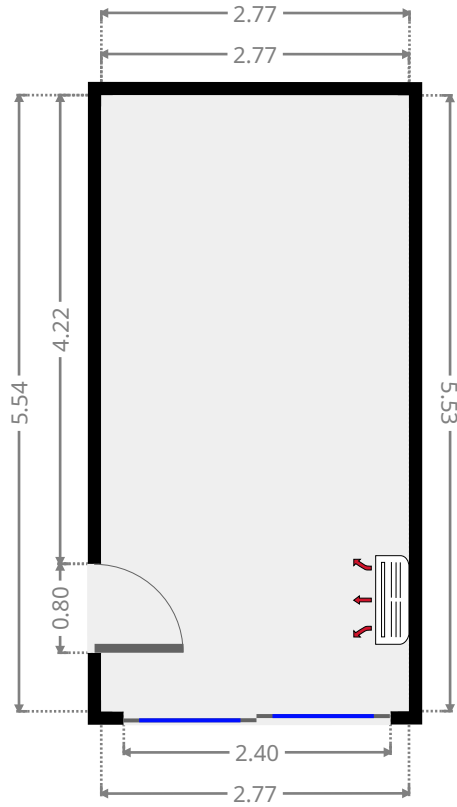
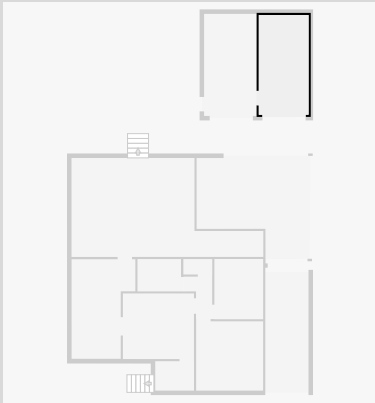

Awning

Width: 5.50 m
 Length: 6.21 m
 Area: 27.97 m²
 Perimeter: 23.33 m

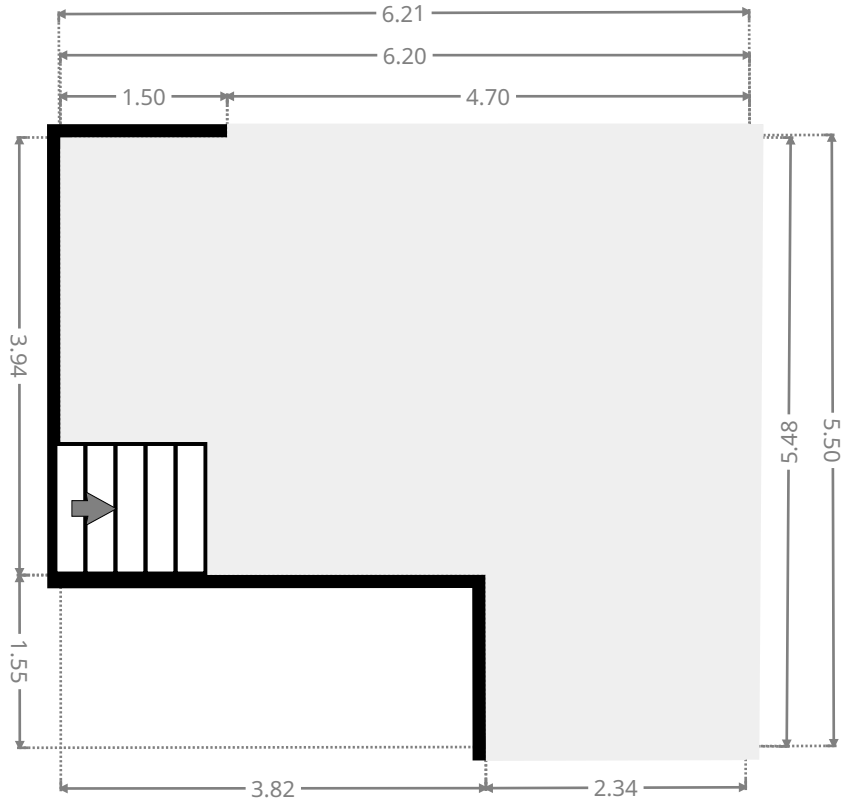
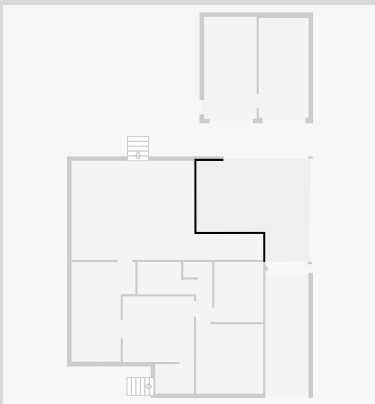

THIS FLOORPLAN IS PROVIDED WITHOUT WARRANTY OF ANY KIND. SENSOPIA DISCLAIMS ANY WARRANTY INCLUDING, WITHOUT LIMITATION, SATISFACTORY QUALITY OR ACCURACY OF DIMENSIONS.

57 Macfarlane Street

•
Width: 1.63 m
Length: 2.15 m
Area: 3.52 m²
Perimeter: 7.57 m

