

56 Donovan Crescent

SUBMITTED BY

Ray White Rockhampton Casey
stockers@cqoz.com

CREATED ON

2022-08-25

Floors

2

▼ Ground Floor

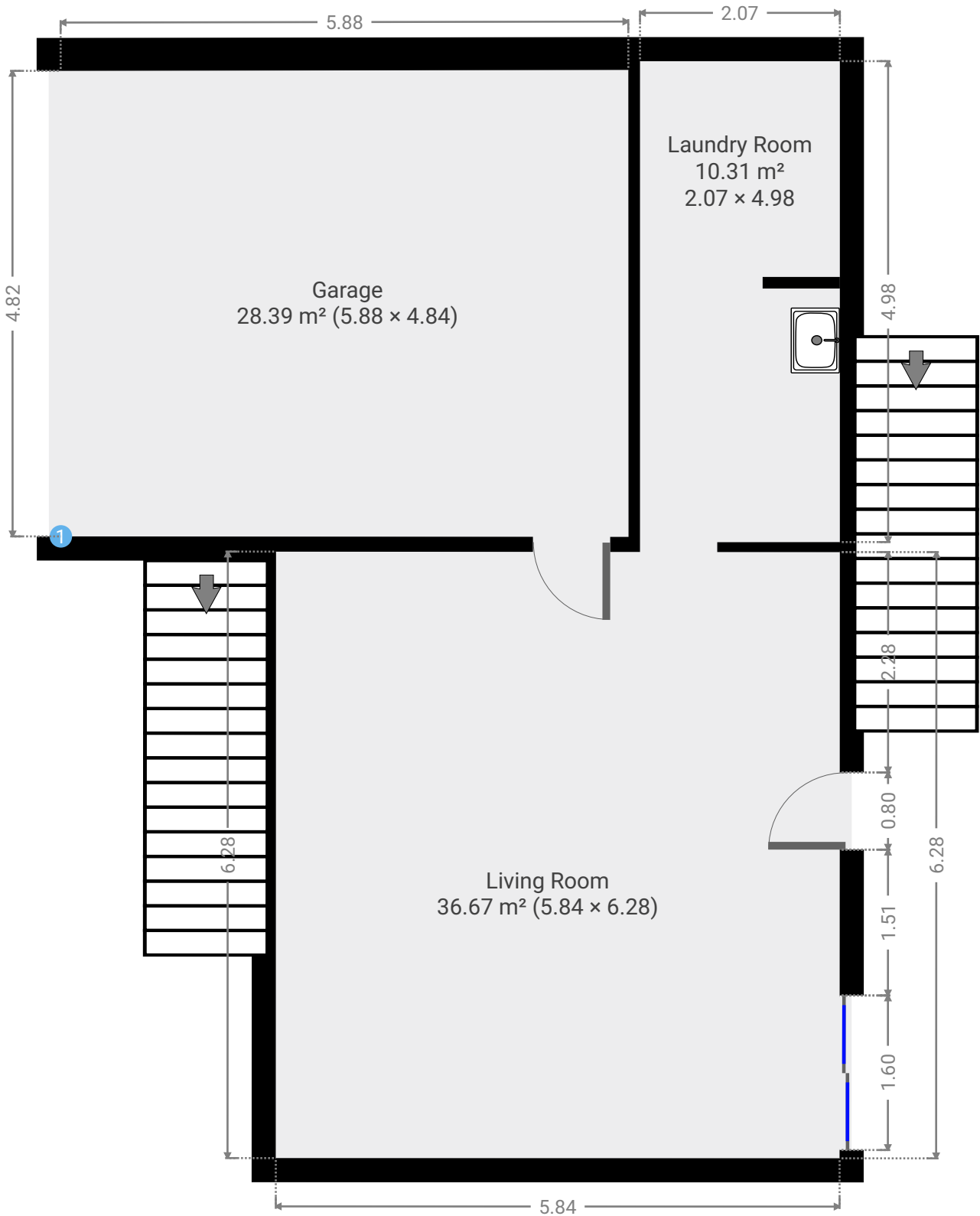

FLOORS: 2

▼ **Garage**
Ground Floor

WIDTH: 4.84 m • LENGTH: 5.88 m
AREA: 28.39 m² • PERIMETER: 21.42 m

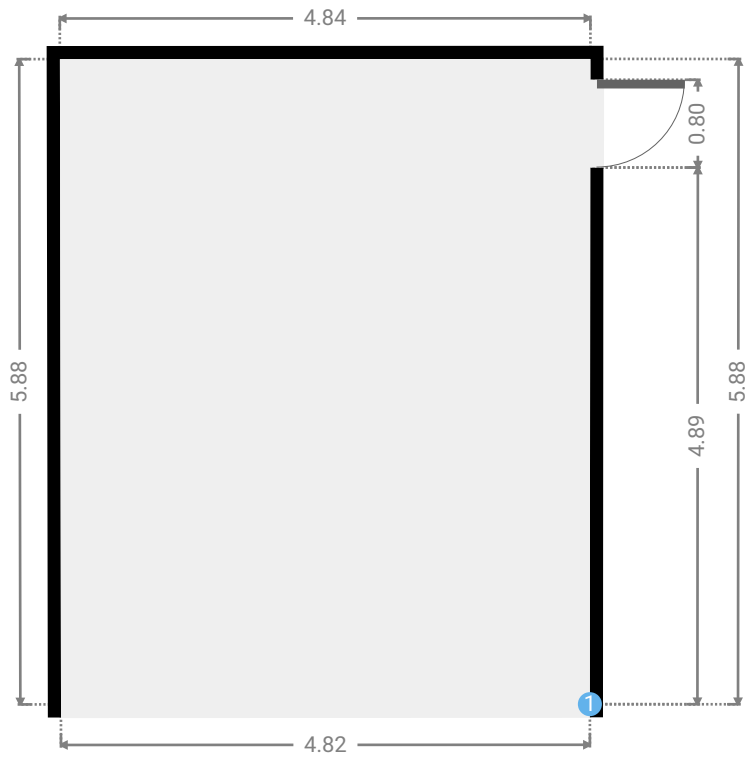
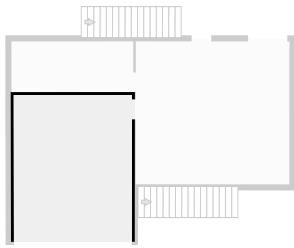

▼ **Garage/Ground Floor**

1 OPENING

Height
0.00 m



FLOORS: 2

▼ Laundry Room
Ground Floor

WIDTH: 4.98 m • LENGTH: 2.07 m
AREA: 10.31 m² • PERIMETER: 14.10 m

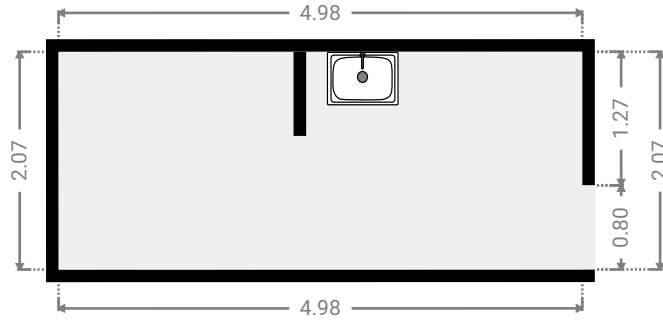
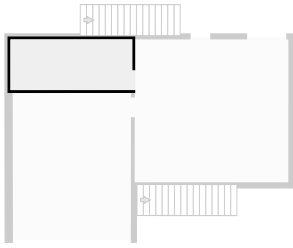

▼ Living Room
Ground Floor

WIDTH: 6.28 m • LENGTH: 5.84 m
AREA: 36.67 m² • PERIMETER: 24.24 m

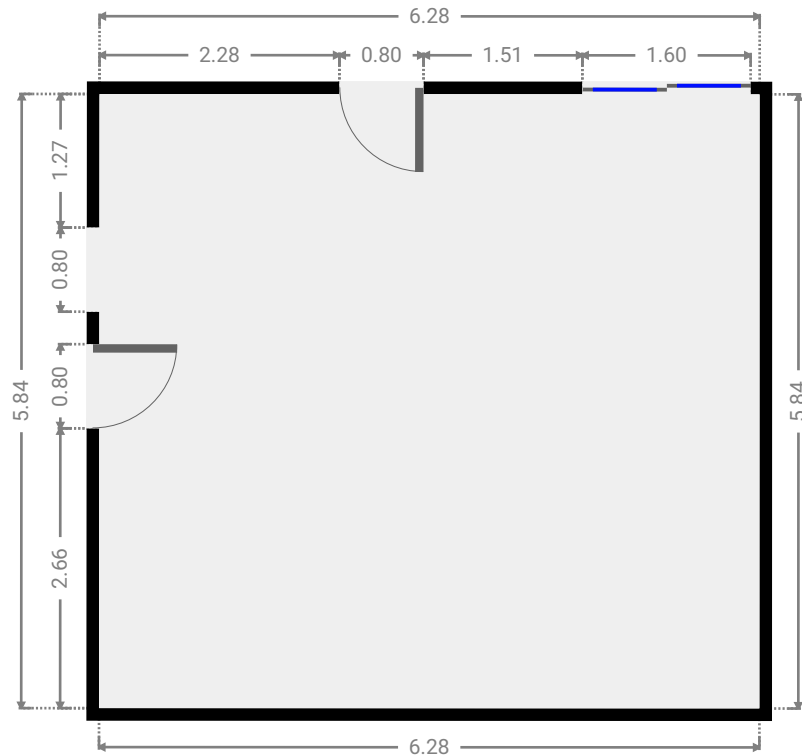
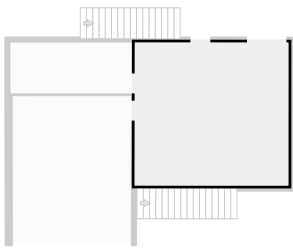

▼ 1st Floor

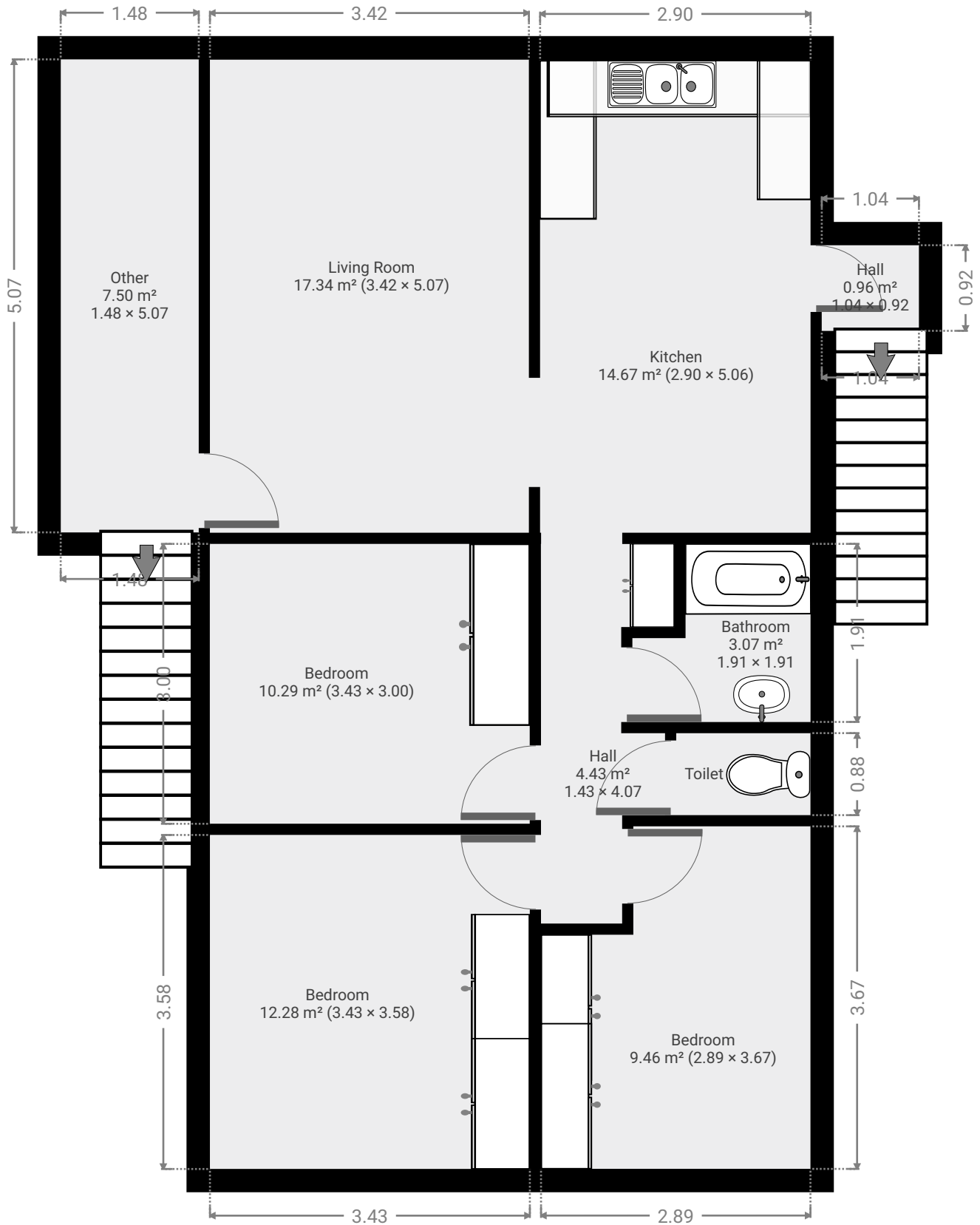

▼ Bathroom
1st Floor

WIDTH: 1.91 m • LENGTH: 1.91 m
AREA: 3.07 m² • PERIMETER: 7.64 m

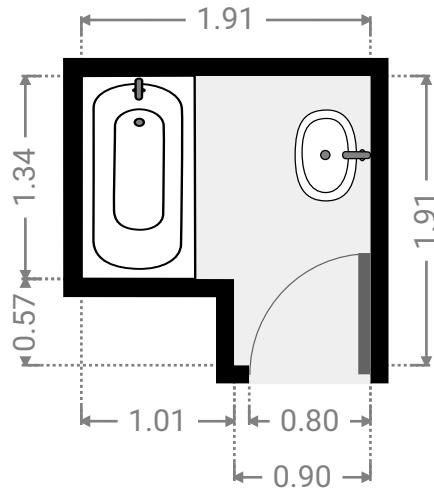
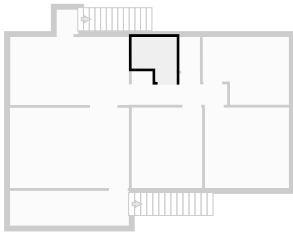

▼ Bedroom
1st Floor

WIDTH: 3.00 m • LENGTH: 3.43 m
AREA: 10.29 m² • PERIMETER: 12.86 m

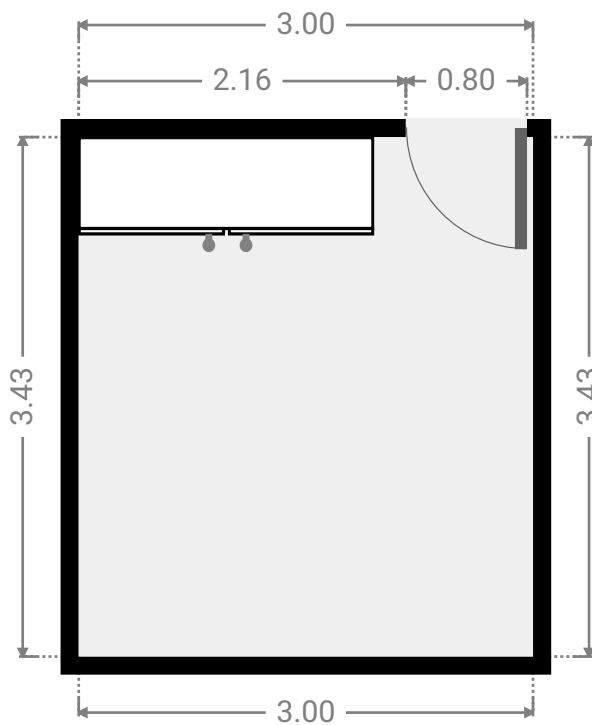
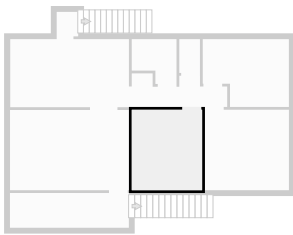

▼ **Bedroom**
1st Floor

WIDTH: 3.58 m • LENGTH: 3.43 m
AREA: 12.28 m² • PERIMETER: 14.02 m

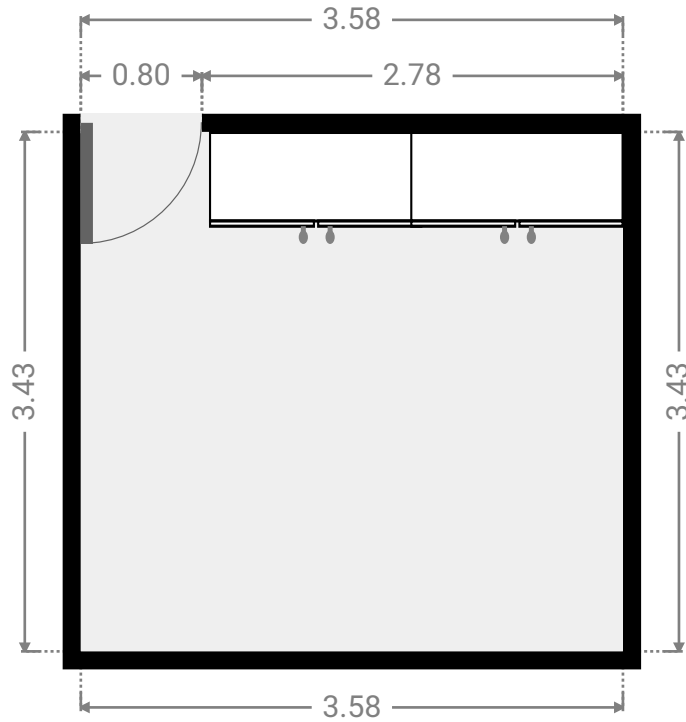
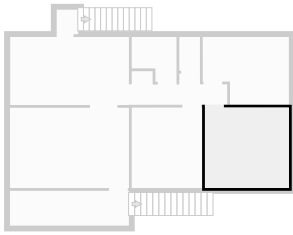

▼ **Bedroom**
1st Floor

WIDTH: 3.67 m • LENGTH: 2.89 m
AREA: 9.46 m² • PERIMETER: 13.12 m

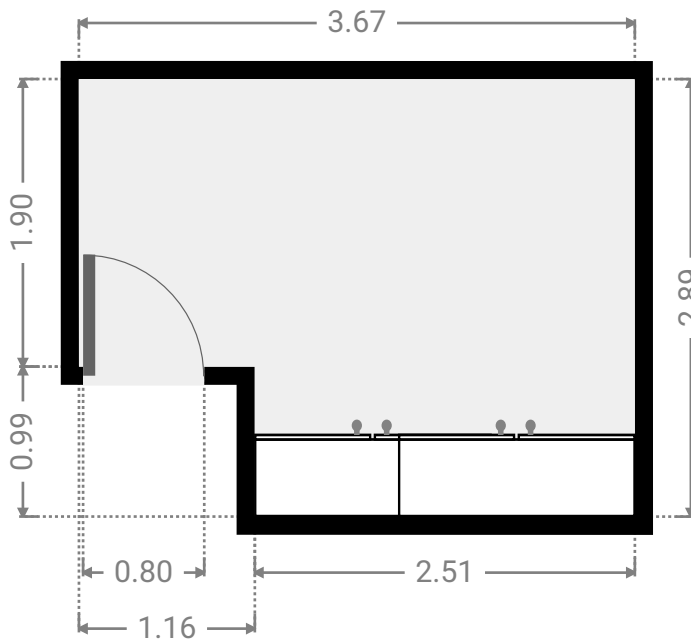
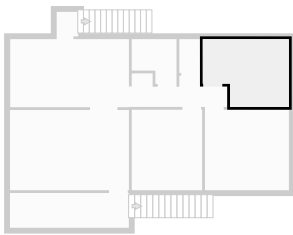

▼ **Hall**
1st Floor

WIDTH: 4.07 m • LENGTH: 1.43 m
AREA: 4.43 m² • PERIMETER: 11.94 m

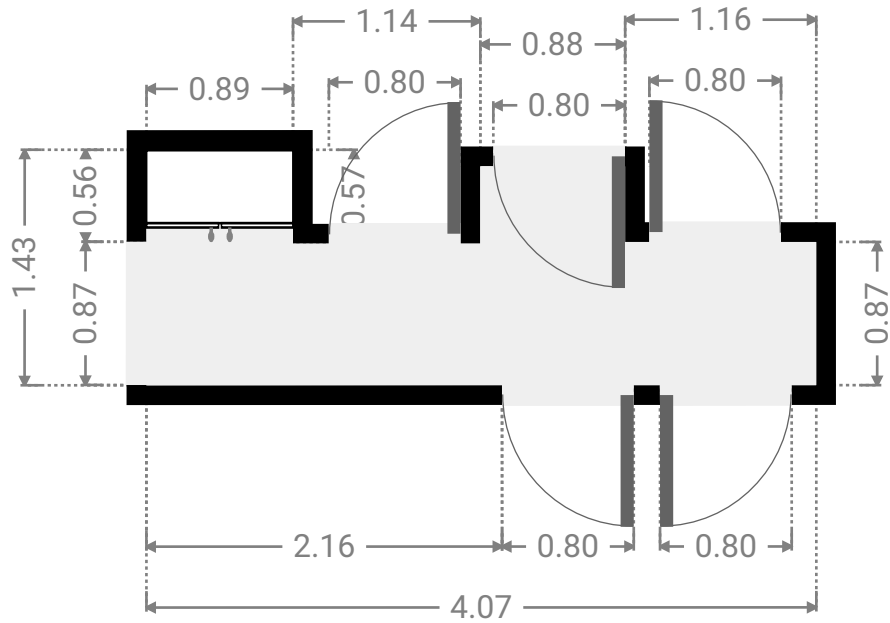
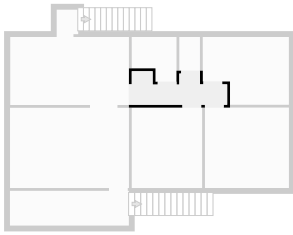

▼ **Hall**
1st Floor

WIDTH: 0.92 m • LENGTH: 1.04 m
AREA: 0.96 m² • PERIMETER: 3.92 m

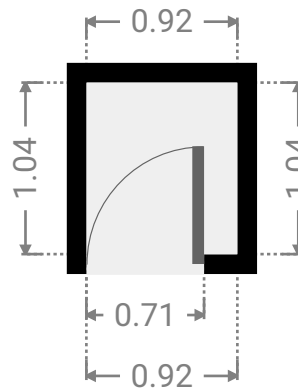
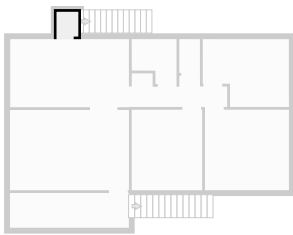

▼ Kitchen
1st Floor

WIDTH: 5.06 m • LENGTH: 2.90 m
AREA: 14.67 m² • PERIMETER: 15.92 m

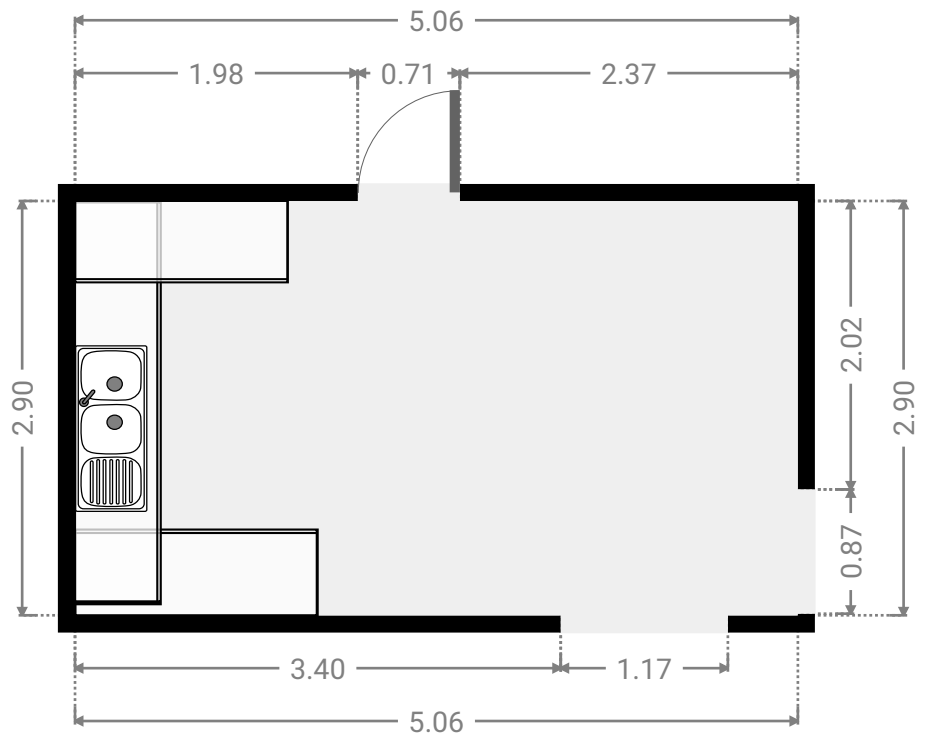
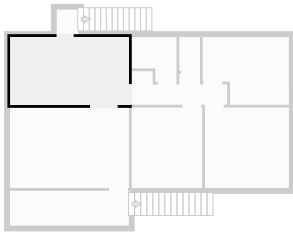

▼ Living Room
1st Floor

WIDTH: 5.07 m • LENGTH: 3.42 m
AREA: 17.34 m² • PERIMETER: 16.98 m

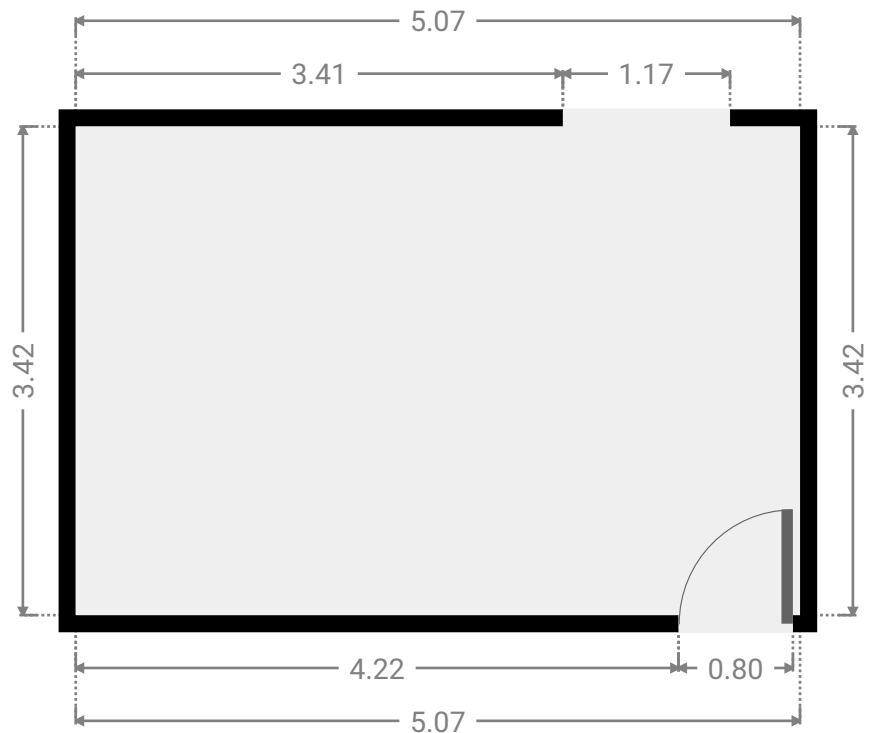
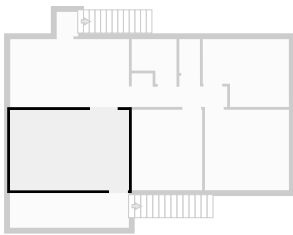

▼ **Other**
1st Floor

WIDTH: 5.07 m • LENGTH: 1.48 m
AREA: 7.50 m² • PERIMETER: 13.10 m

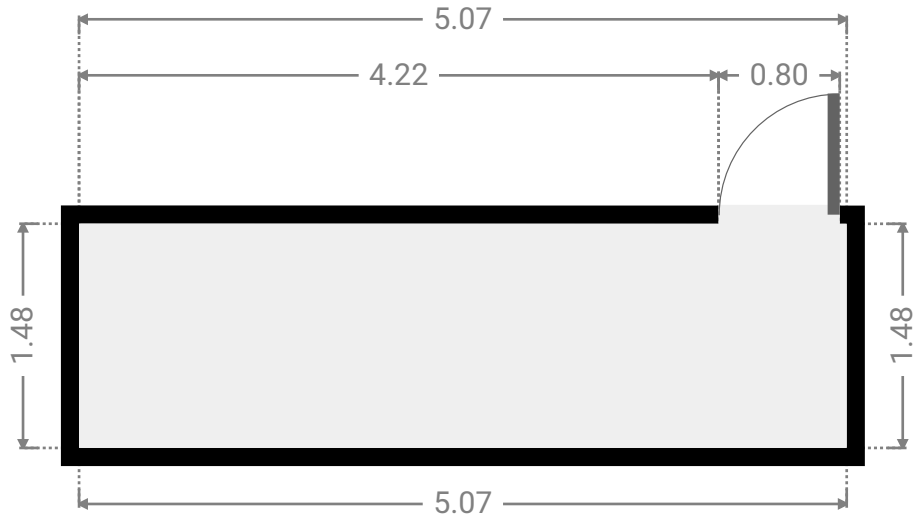
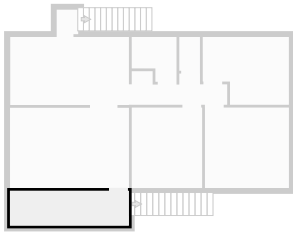

▼ **Toilet**
1st Floor

WIDTH: 0.88 m • LENGTH: 1.44 m
AREA: 1.26 m² • PERIMETER: 4.64 m

