

# 55 Pillich Street

Created on  
2019-04-23

Floors  
1

▼ Ground Floor

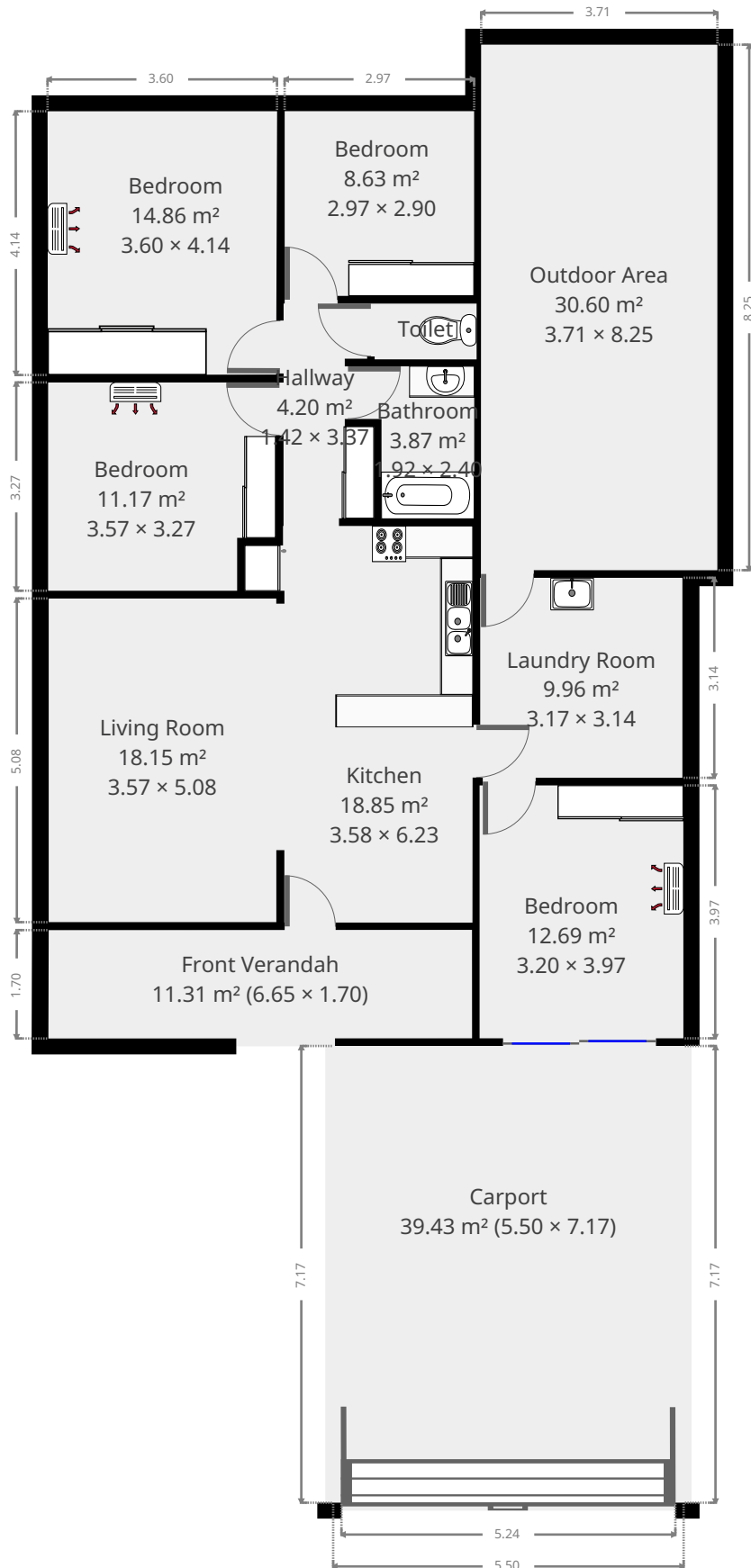

THIS FLOORPLAN IS PROVIDED WITHOUT WARRANTY OF ANY KIND. SENSOPIA DISCLAIMS ANY WARRANTY INCLUDING, WITHOUT LIMITATION, SATISFACTORY QUALITY OR ACCURACY OF DIMENSIONS.



▼ **Kitchen**  
Ground Floor

**WIDTH:** 3.58 m • **LENGTH:** 6.23 m  
**AREA:** 18.85 m<sup>2</sup> • **PERIMETER:** 19.61 m

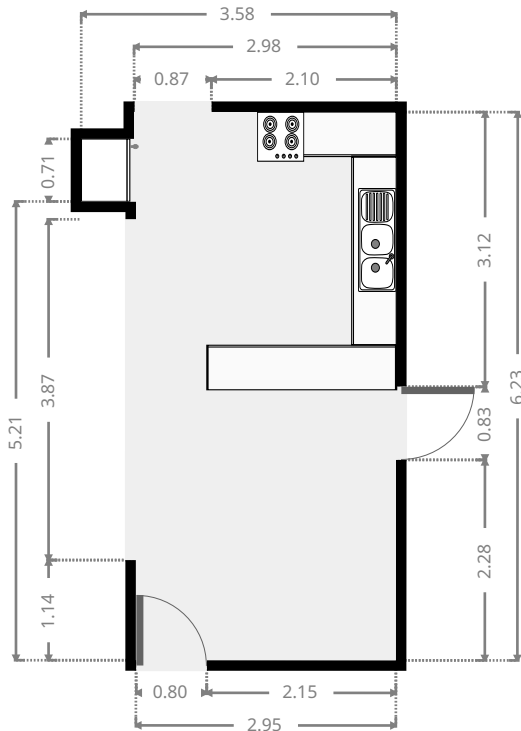
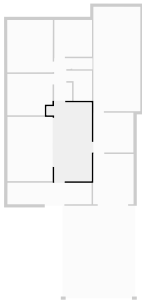

▼ **Living Room**  
Ground Floor

**WIDTH:** 3.57 m • **LENGTH:** 5.08 m  
**AREA:** 18.15 m<sup>2</sup> • **PERIMETER:** 17.31 m

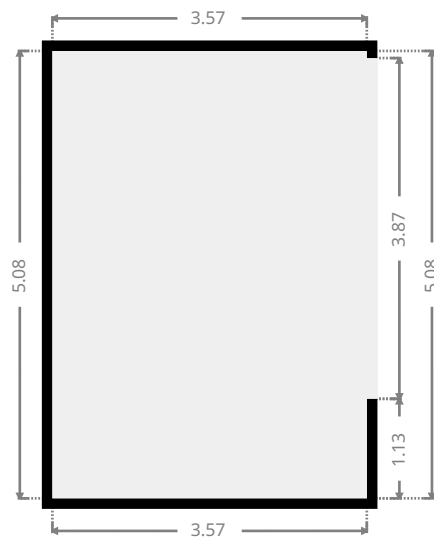
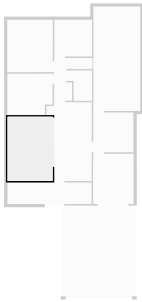

▼ **Hallway**  
Ground Floor

WIDTH: 1.42 m • LENGTH: 3.37 m  
AREA: 4.20 m<sup>2</sup> • PERIMETER: 10.28 m

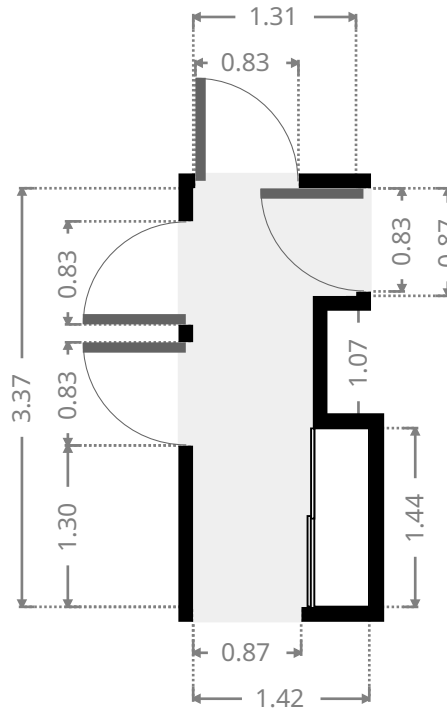
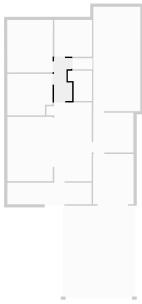

▼ **Bedroom**  
Ground Floor

WIDTH: 3.57 m • LENGTH: 3.27 m  
AREA: 11.17 m<sup>2</sup> • PERIMETER: 13.68 m

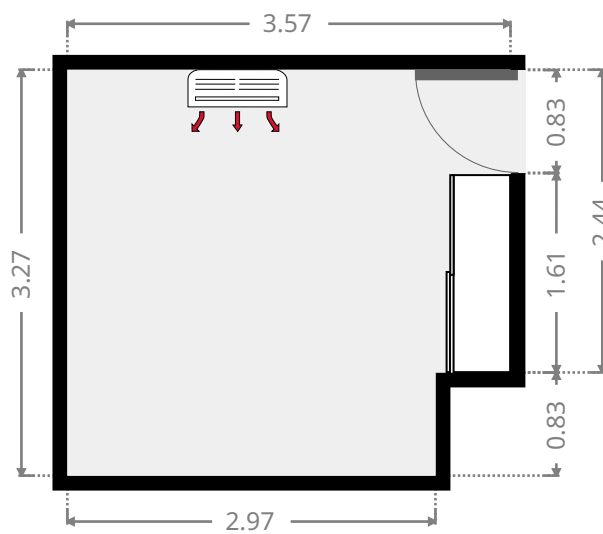
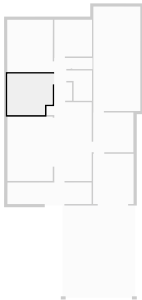

▼ **Bathroom**  
Ground Floor

WIDTH: 1.92 m • LENGTH: 2.40 m  
AREA: 3.87 m<sup>2</sup> • PERIMETER: 8.64 m

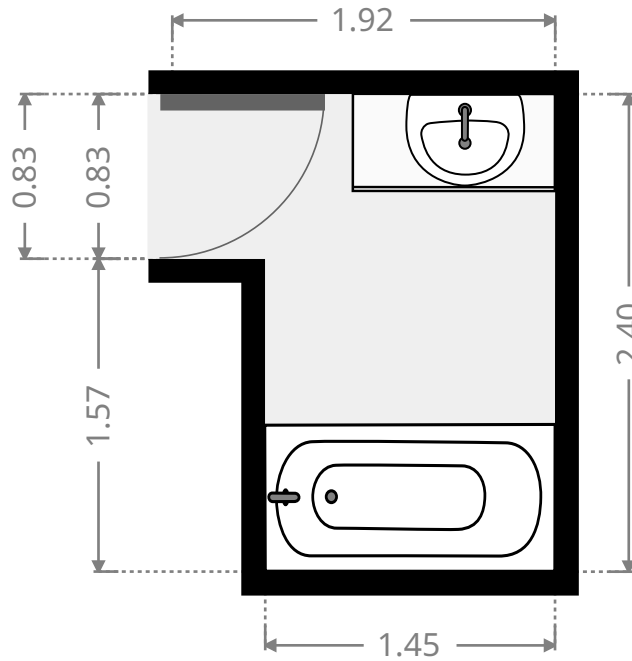
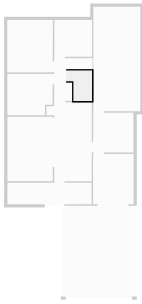

▼ **Toilet**  
Ground Floor

WIDTH: 1.60 m • LENGTH: 0.88 m  
AREA: 1.40 m<sup>2</sup> • PERIMETER: 4.95 m

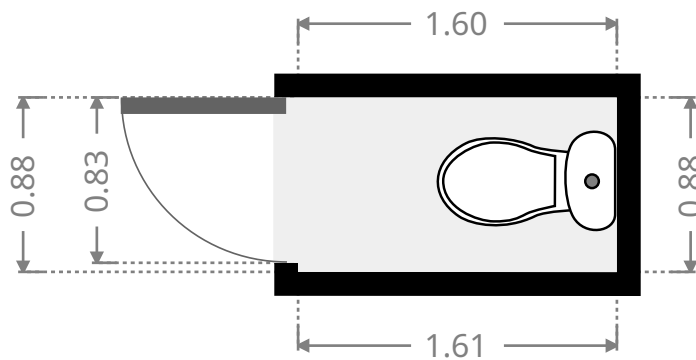
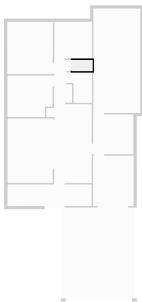

▼ **Bedroom**  
Ground Floor

WIDTH: 2.97 m • LENGTH: 2.90 m  
AREA: 8.63 m<sup>2</sup> • PERIMETER: 11.75 m

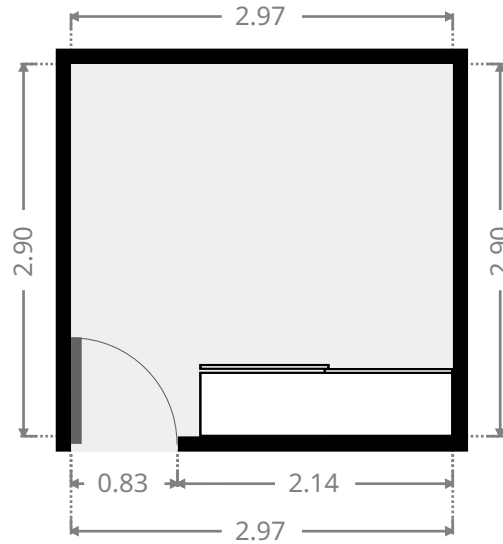
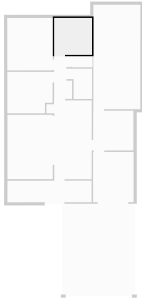

▼ **Bedroom**  
Ground Floor

WIDTH: 3.60 m • LENGTH: 4.14 m  
AREA: 14.86 m<sup>2</sup> • PERIMETER: 15.46 m

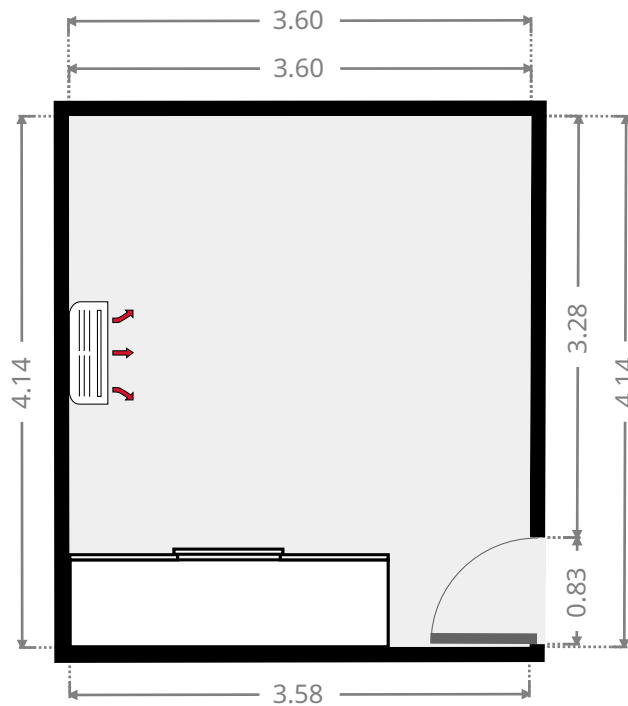
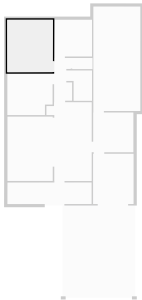

▼ **Laundry Room**  
Ground Floor

**WIDTH:** 3.17 m • **LENGTH:** 3.14 m  
**AREA:** 9.96 m<sup>2</sup> • **PERIMETER:** 12.62 m

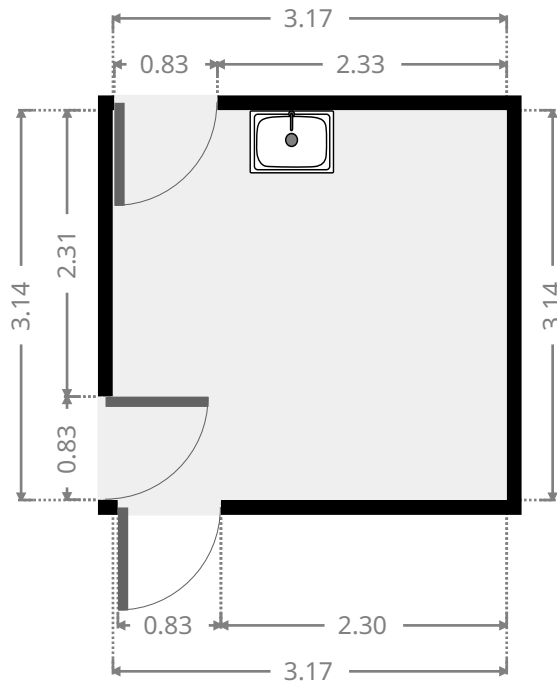
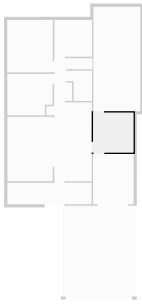

▼ **Bedroom**  
Ground Floor

**WIDTH:** 3.20 m • **LENGTH:** 3.97 m  
**AREA:** 12.69 m<sup>2</sup> • **PERIMETER:** 14.33 m

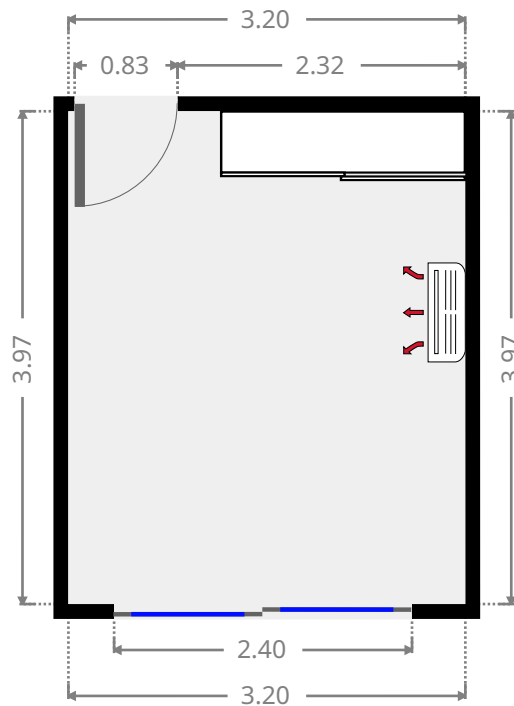
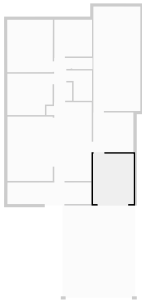

▼ **Outdoor Area**  
Ground Floor

**WIDTH:** 3.71 m • **LENGTH:** 8.25 m  
**AREA:** 30.60 m<sup>2</sup> • **PERIMETER:** 23.92 m

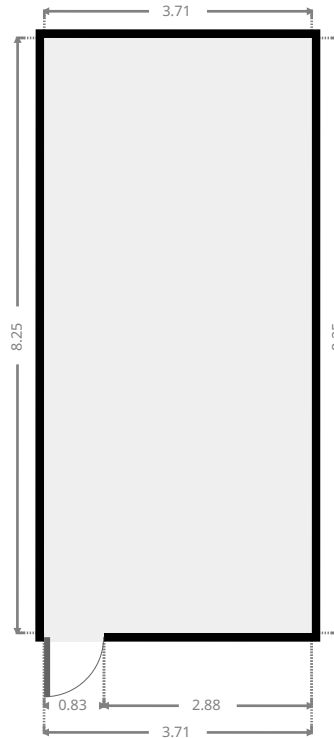
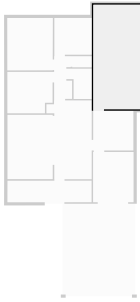

▼ **Front Verandah**  
Ground Floor

**WIDTH:** 6.65 m • **LENGTH:** 1.70 m  
**AREA:** 11.31 m<sup>2</sup> • **PERIMETER:** 16.70 m

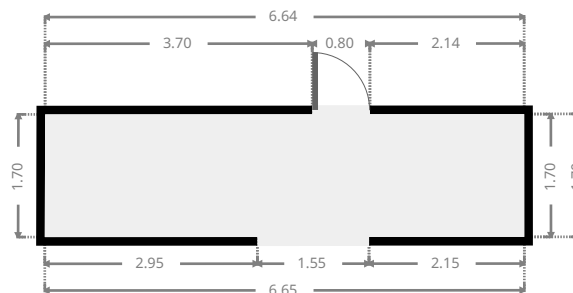
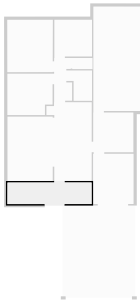



▼ **Carpport**  
Ground Floor

**WIDTH:** 5.50 m • **LENGTH:** 7.17 m  
**AREA:** 39.43 m<sup>2</sup> • **PERIMETER:** 25.34 m

