

# 54 Rosewood Drive

## Ground Floor



THIS FLOORPLAN IS PROVIDED WITHOUT WARRANTY OF ANY KIND. SENSOPIA DISCLAIMS ANY WARRANTY INCLUDING, WITHOUT LIMITATION, SATISFACTORY QUALITY OR ACCURACY OF DIMENSIONS.



# 54 Rosewood Drive

## Hall

Width: 1.76 m  
 Length: 3.37 m  
 Area: 3.85 m<sup>2</sup>  
 Perimeter: 9.42 m

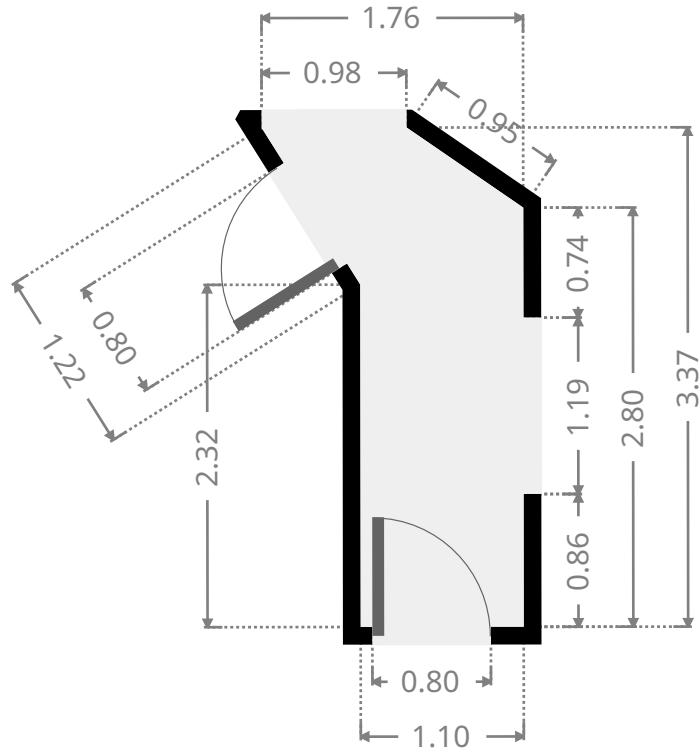
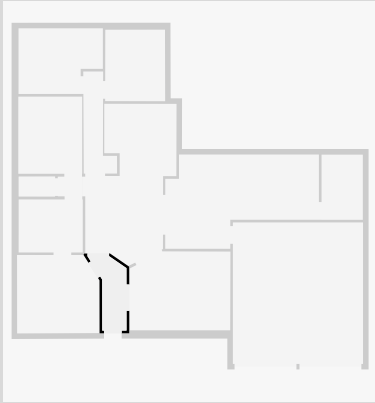

## Living Room

Width: 3.57 m  
 Length: 4.55 m  
 Area: 15.64 m<sup>2</sup>  
 Perimeter: 15.64 m

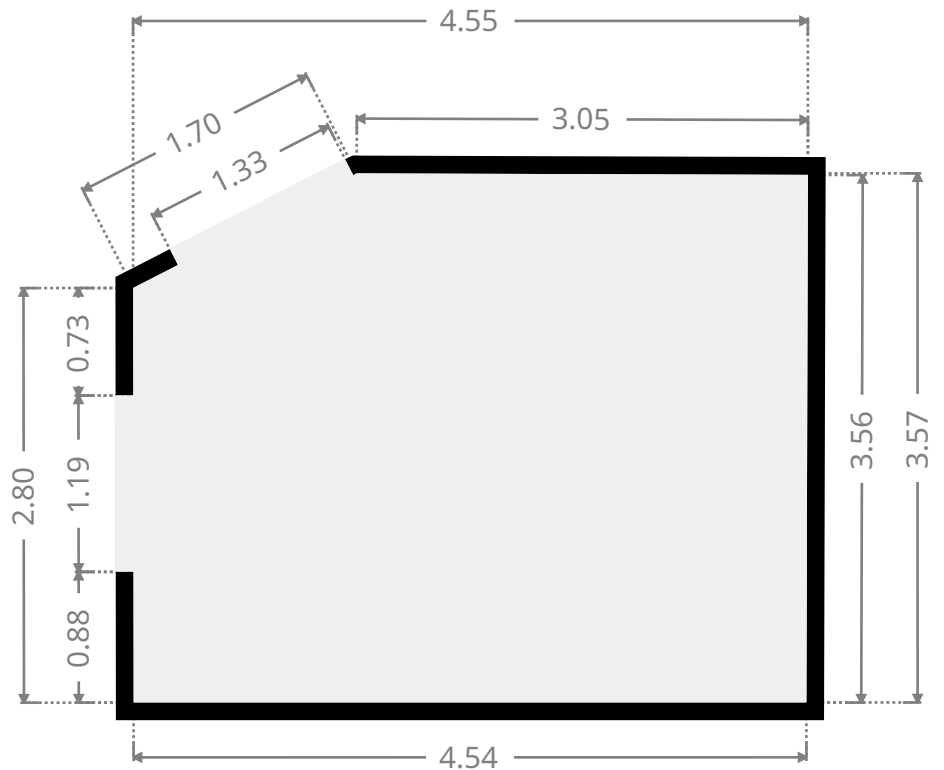
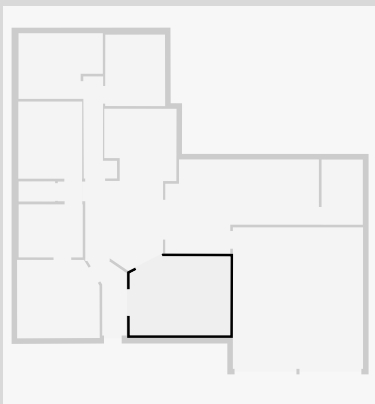

THIS FLOORPLAN IS PROVIDED WITHOUT WARRANTY OF ANY KIND. SENSOPIA DISCLAIMS ANY WARRANTY INCLUDING, WITHOUT LIMITATION, SATISFACTORY QUALITY OR ACCURACY OF DIMENSIONS.

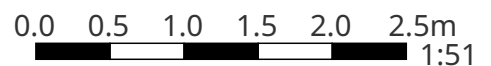

# 54 Rosewood Drive

## Master Bedroom

Width: 3.55 m  
 Length: 3.74 m  
 Area: 12.80 m<sup>2</sup>  
 Perimeter: 14.04 m

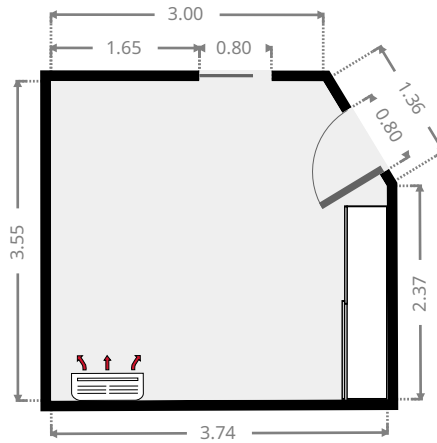
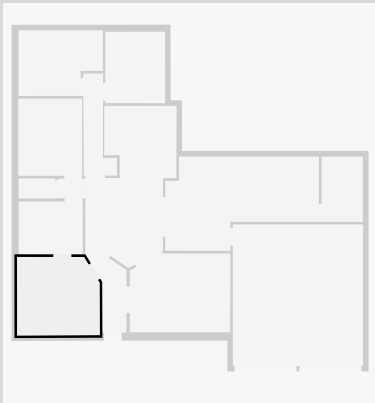

## Kitchen/Living/Dining

Width: 4.13 m  
 Length: 7.34 m  
 Area: 22.80 m<sup>2</sup>  
 Perimeter: 23.33 m

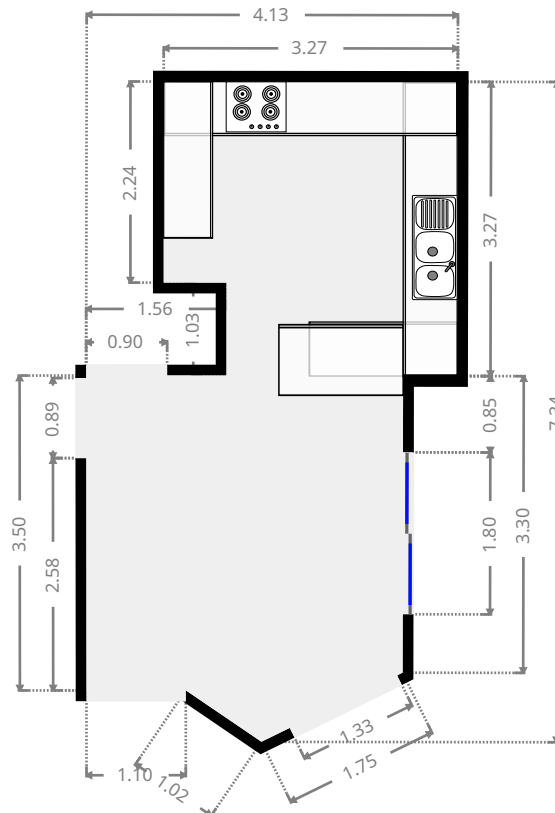
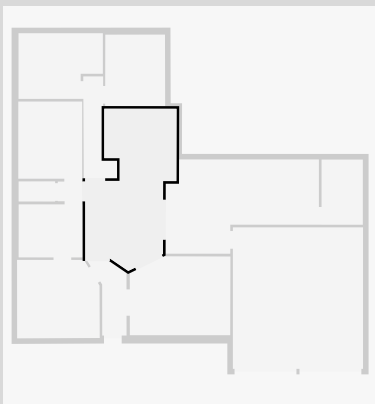

THIS FLOORPLAN IS PROVIDED WITHOUT WARRANTY OF ANY KIND. SENSOPIA DISCLAIMS ANY WARRANTY INCLUDING, WITHOUT LIMITATION, SATISFACTORY QUALITY OR ACCURACY OF DIMENSIONS.



# 54 Rosewood Drive

## Bathroom

Width: 2.40 m  
Length: 2.90 m  
Area: 6.96 m<sup>2</sup>  
Perimeter: 10.60 m

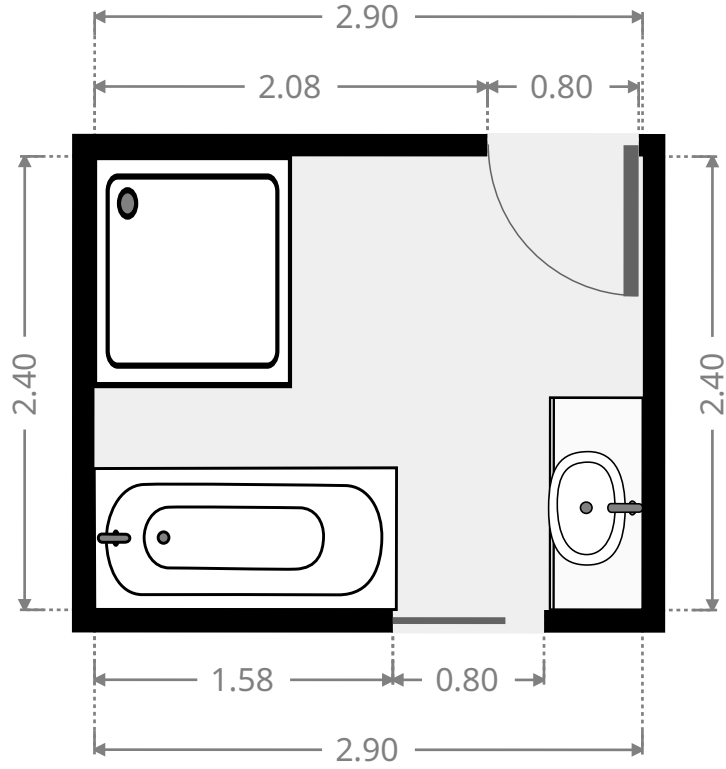
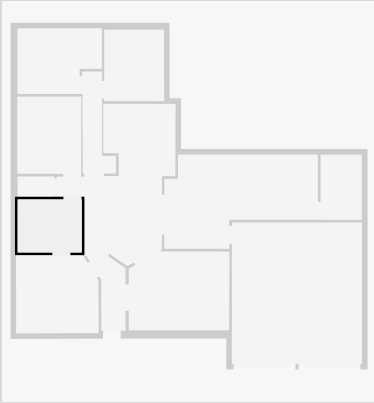

## Hall

Width: 0.89 m  
Length: 1.11 m  
Area: 0.99 m<sup>2</sup>  
Perimeter: 4.00 m

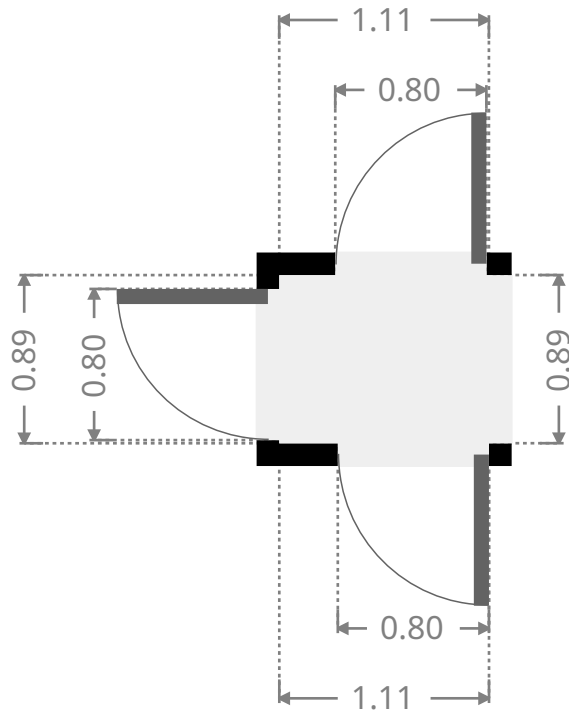
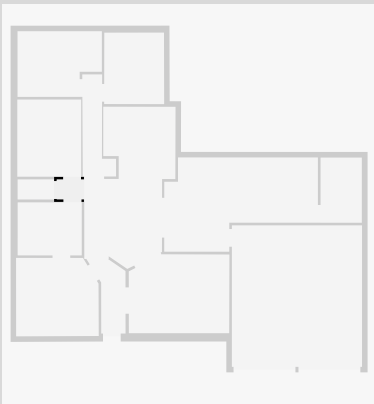

THIS FLOORPLAN IS PROVIDED WITHOUT WARRANTY OF ANY KIND. SENSOPIA DISCLAIMS ANY WARRANTY INCLUDING, WITHOUT LIMITATION, SATISFACTORY QUALITY OR ACCURACY OF DIMENSIONS.

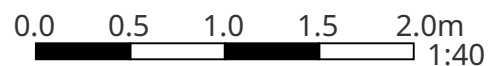

# 54 Rosewood Drive

## Toilet / Half Bath

Width: 0.91 m  
Length: 1.65 m  
Area: 1.50 m<sup>2</sup>  
Perimeter: 5.12 m

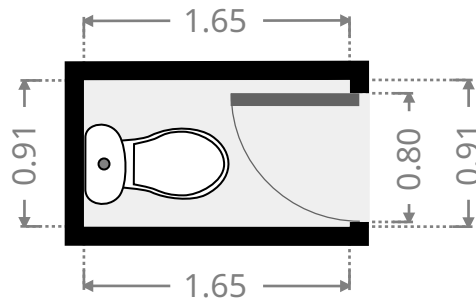
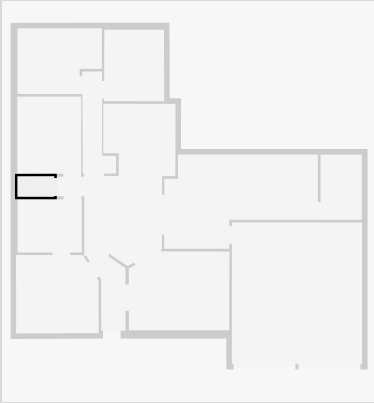

## Bedroom

Width: 2.89 m  
Length: 3.49 m  
Area: 10.09 m<sup>2</sup>  
Perimeter: 12.76 m

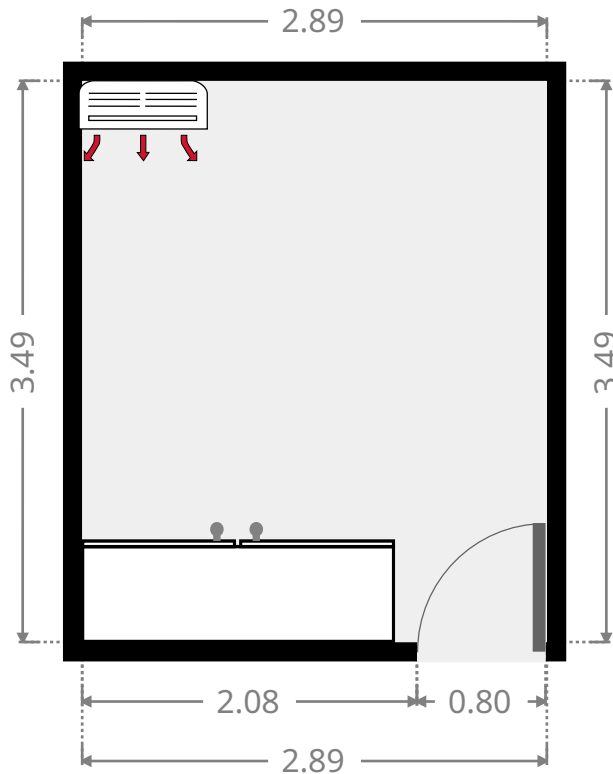
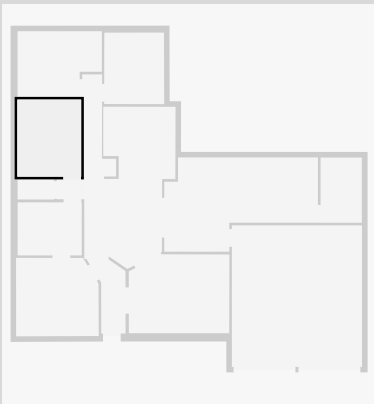

# 54 Rosewood Drive

## Hall

Width: 1.53 m  
 Length: 4.62 m  
 Area: 4.59 m<sup>2</sup>  
 Perimeter: 12.28 m

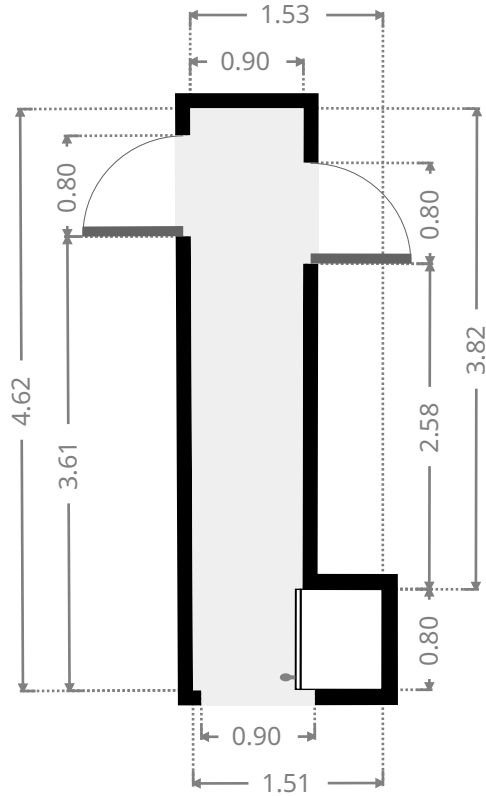
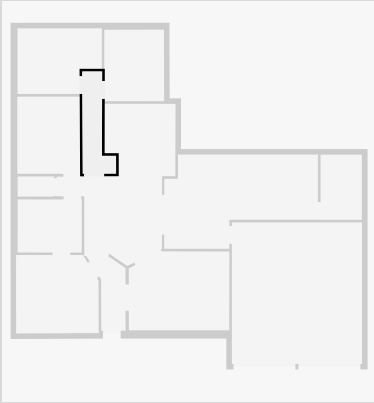

## Bedroom

Width: 2.97 m  
 Length: 3.81 m  
 Area: 10.19 m<sup>2</sup>  
 Perimeter: 13.57 m

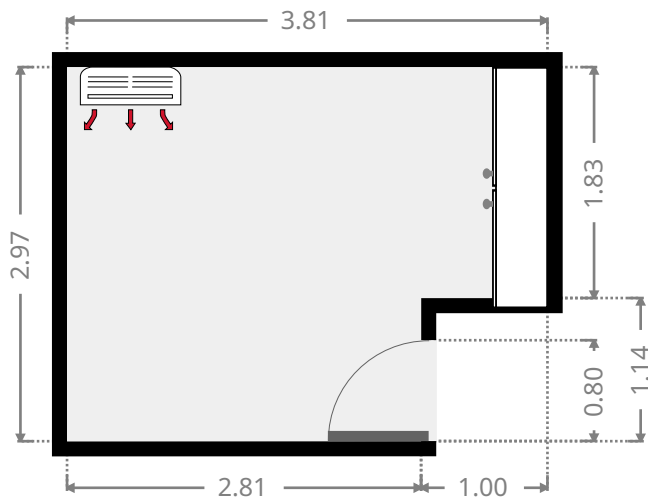
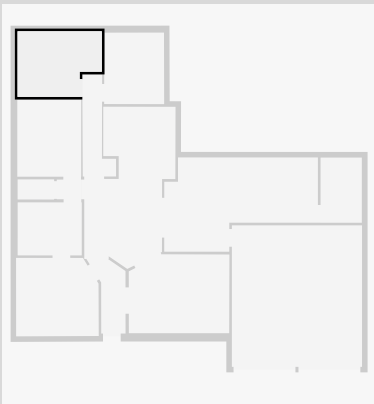

THIS FLOORPLAN IS PROVIDED WITHOUT WARRANTY OF ANY KIND. SENSOPIA DISCLAIMS ANY WARRANTY INCLUDING, WITHOUT LIMITATION, SATISFACTORY QUALITY OR ACCURACY OF DIMENSIONS.

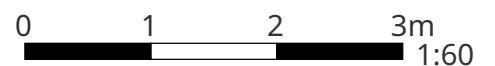

# 54 Rosewood Drive

## Bedroom

Width: 2.72 m  
Length: 3.24 m  
Area: 8.76 m<sup>2</sup>  
Perimeter: 11.88 m

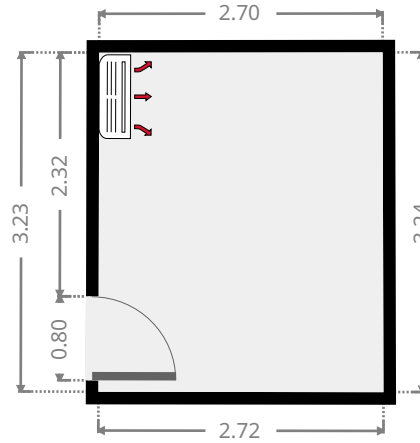
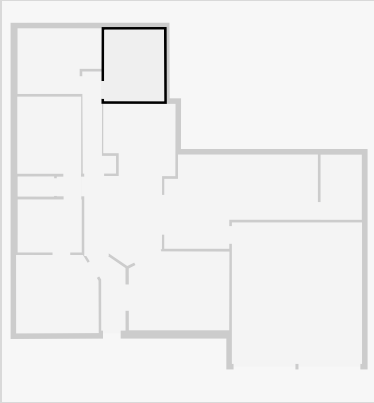

## Other

Width: 4.26 m  
Length: 6.95 m  
Area: 23.69 m<sup>2</sup>  
Perimeter: 22.43 m

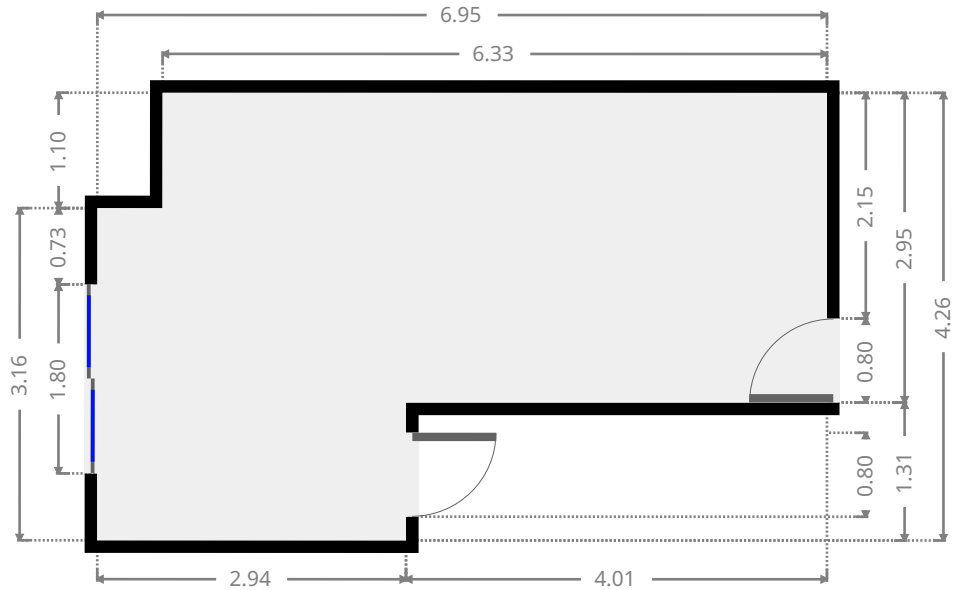
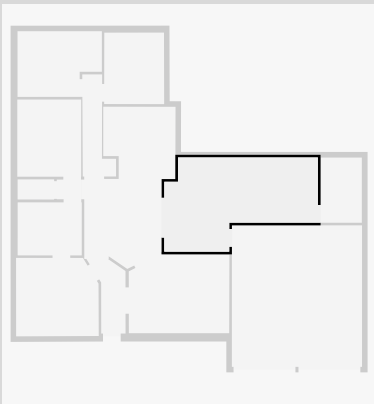

THIS FLOORPLAN IS PROVIDED WITHOUT WARRANTY OF ANY KIND. SENSOPIA DISCLAIMS ANY WARRANTY INCLUDING, WITHOUT LIMITATION, SATISFACTORY QUALITY OR ACCURACY OF DIMENSIONS.



# 54 Rosewood Drive

## Garage

Width: 5.89 m  
 Length: 6.40 m  
 Area: 37.69 m<sup>2</sup>  
 Perimeter: 24.58 m

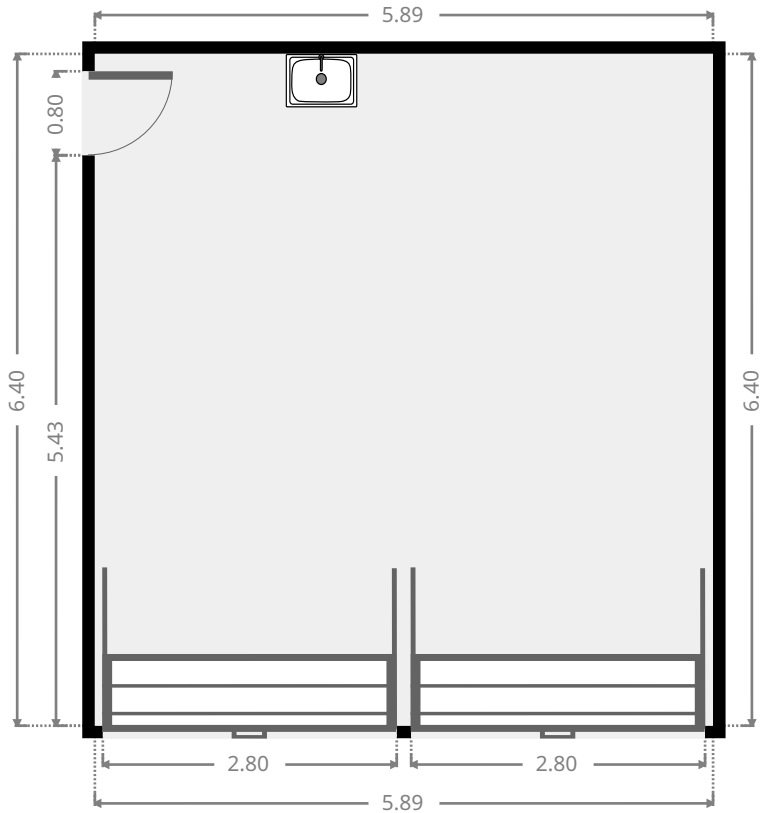
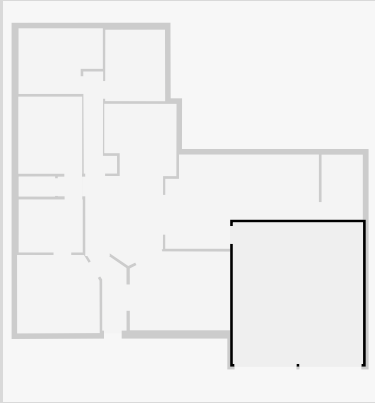

## Closet

Width: 1.87 m  
 Length: 2.95 m  
 Area: 5.50 m<sup>2</sup>  
 Perimeter: 9.63 m

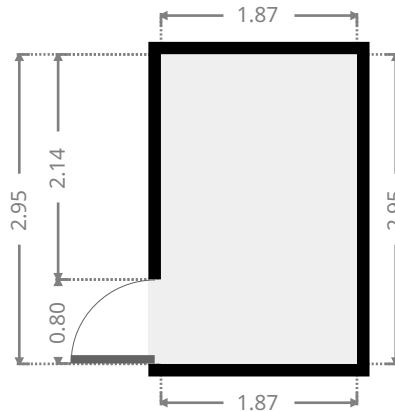
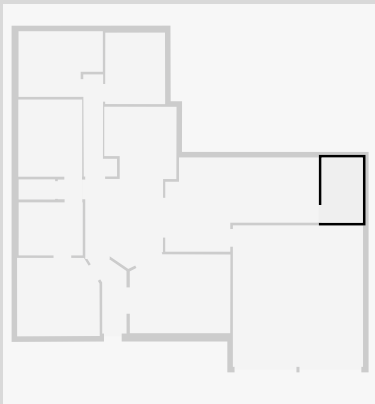

THIS FLOORPLAN IS PROVIDED WITHOUT WARRANTY OF ANY KIND. SENSOPIA DISCLAIMS ANY WARRANTY INCLUDING, WITHOUT LIMITATION, SATISFACTORY QUALITY OR ACCURACY OF DIMENSIONS.

