

# Ground Floor

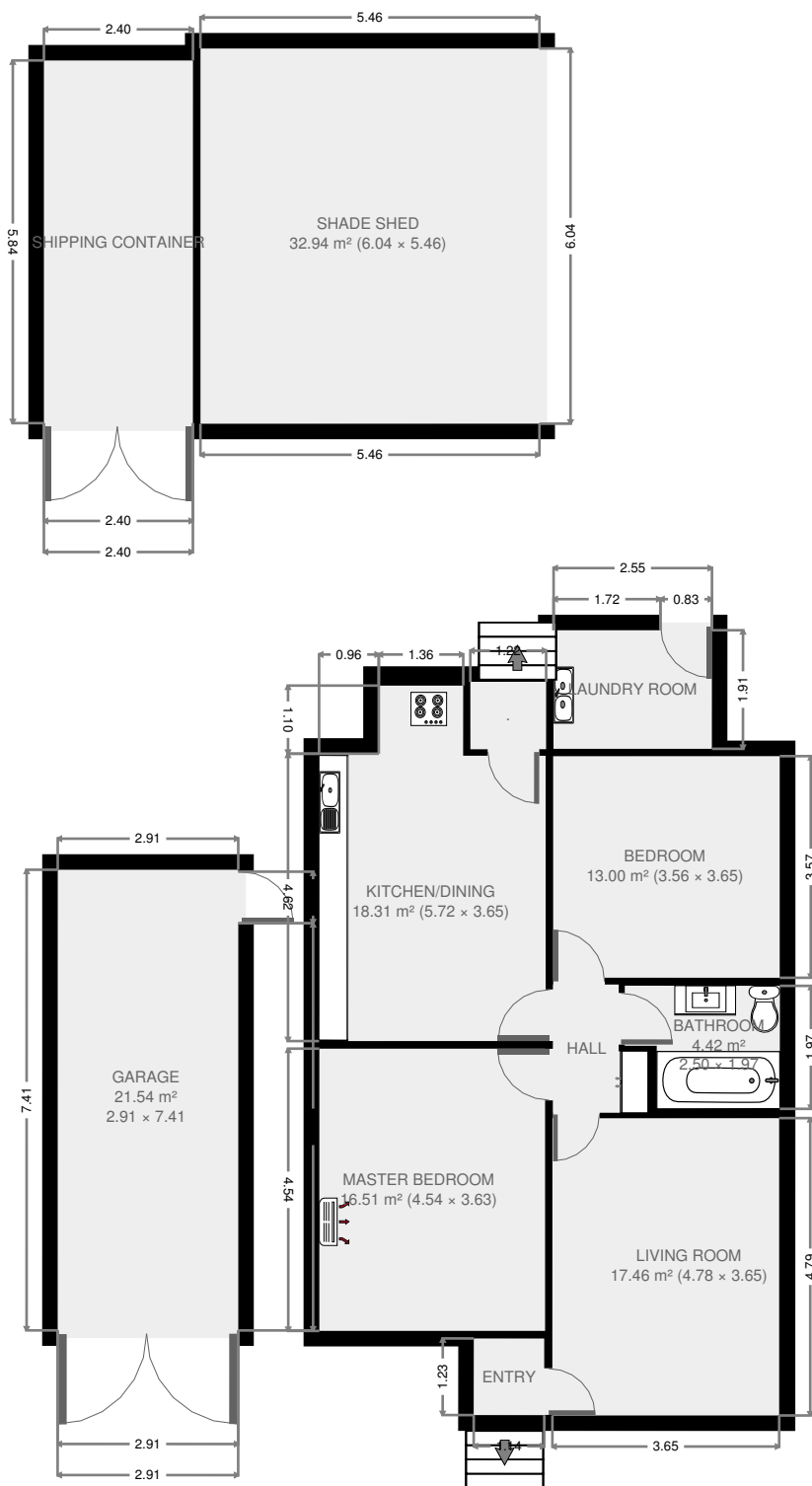

THIS FLOORPLAN IS PROVIDED WITHOUT WARRANTY OF ANY KIND. SENSOPIA DISCLAIMS ANY WARRANTY INCLUDING, WITHOUT LIMITATION, SATISFACTORY QUALITY OR ACCURACY OF DIMENSIONS.

## 53 Heath Street

# Living Room

Width: 3.65 m  
 Length: 4.78 m  
 Area: 17.46 m<sup>2</sup>  
 Perimeter: 16.87 m

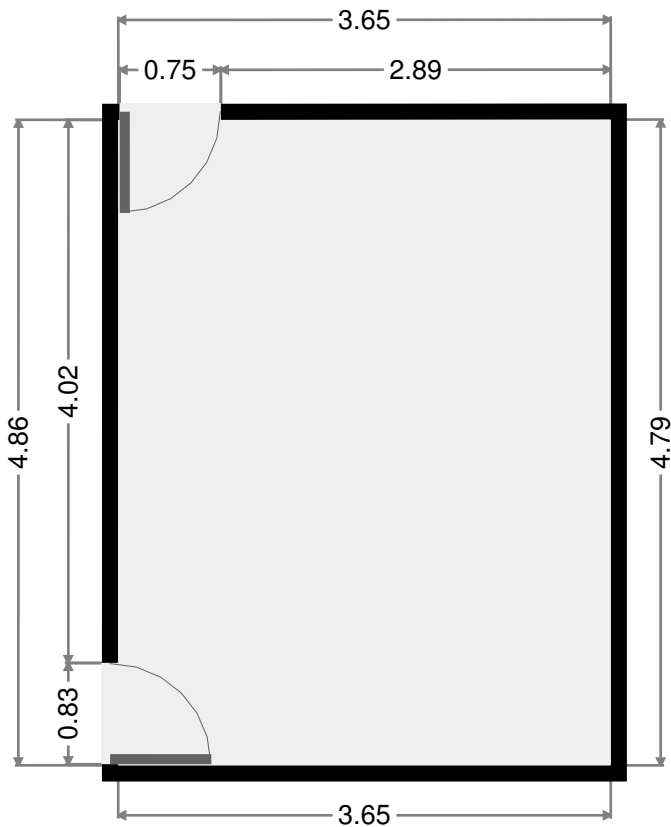

# Hall

Width: 1.53 m  
 Length: 2.06 m  
 Area: 2.65 m<sup>2</sup>  
 Perimeter: 7.19 m

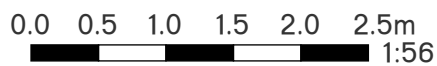
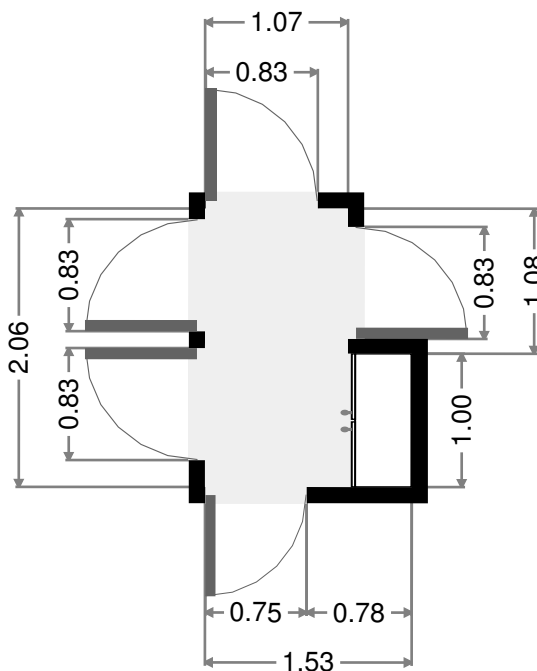
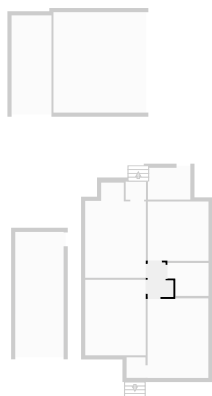

THIS FLOORPLAN IS PROVIDED WITHOUT WARRANTY OF ANY KIND. SENSOPIA DISCLAIMS ANY WARRANTY INCLUDING, WITHOUT LIMITATION, SATISFACTORY QUALITY OR ACCURACY OF DIMENSIONS.

# Master Bedroom

Width: 3.63 m  
 Length: 4.54 m  
 Area: 16.51 m<sup>2</sup>  
 Perimeter: 16.35 m

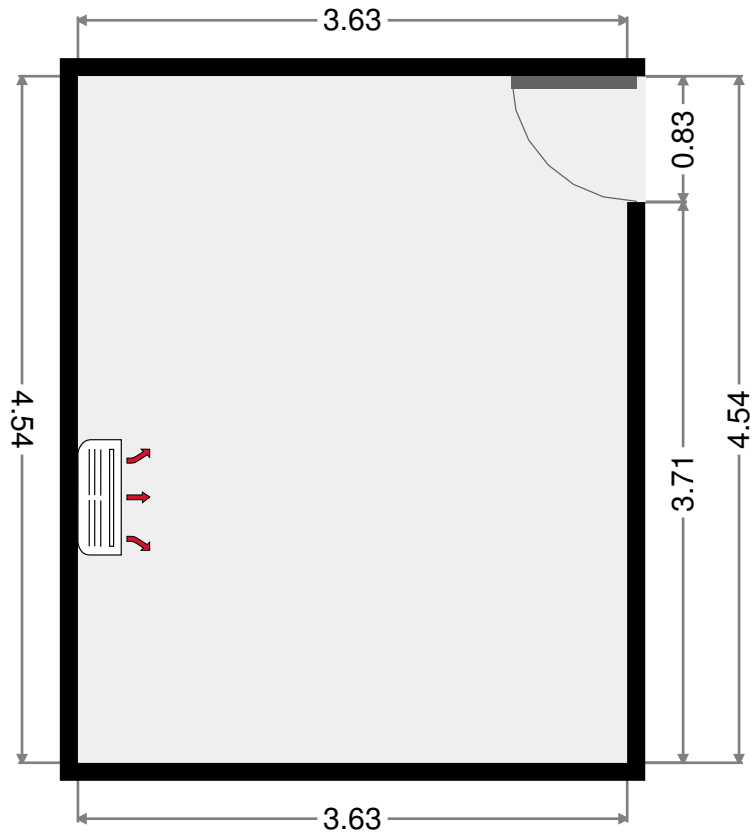
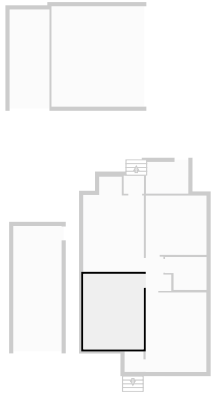

# Bathroom

Width: 1.97 m  
 Length: 2.50 m  
 Area: 4.42 m<sup>2</sup>  
 Perimeter: 8.95 m

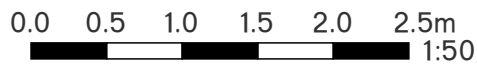
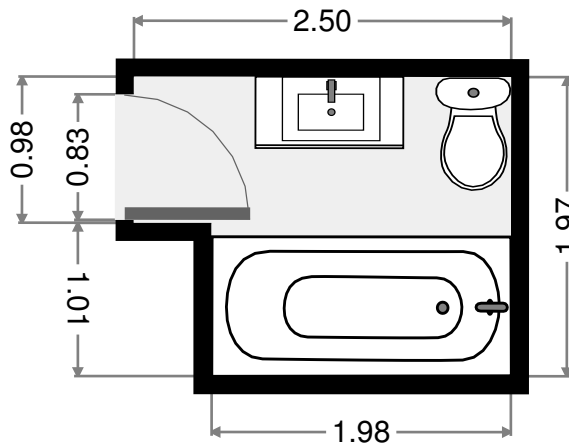
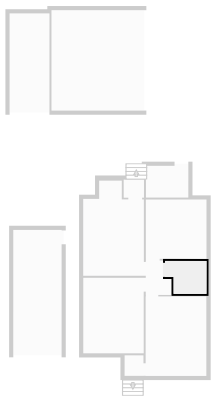

THIS FLOORPLAN IS PROVIDED WITHOUT WARRANTY OF ANY KIND. SENSOPIA DISCLAIMS ANY WARRANTY INCLUDING, WITHOUT LIMITATION, SATISFACTORY QUALITY OR ACCURACY OF DIMENSIONS.

# Bedroom

Width: 3.56 m  
 Length: 3.65 m  
 Area: 13.00 m<sup>2</sup>  
 Perimeter: 14.42 m

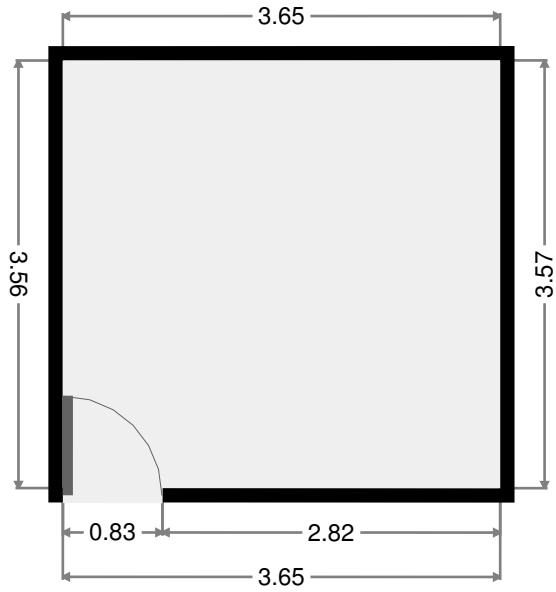
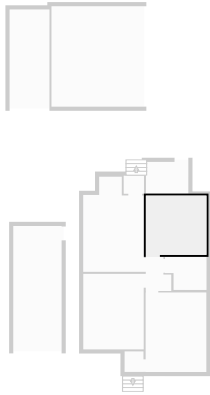

# Kitchen/Dining

Width: 3.65 m  
 Length: 5.72 m  
 Area: 18.31 m<sup>2</sup>  
 Perimeter: 18.73 m

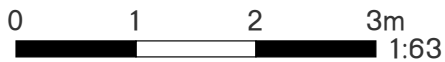
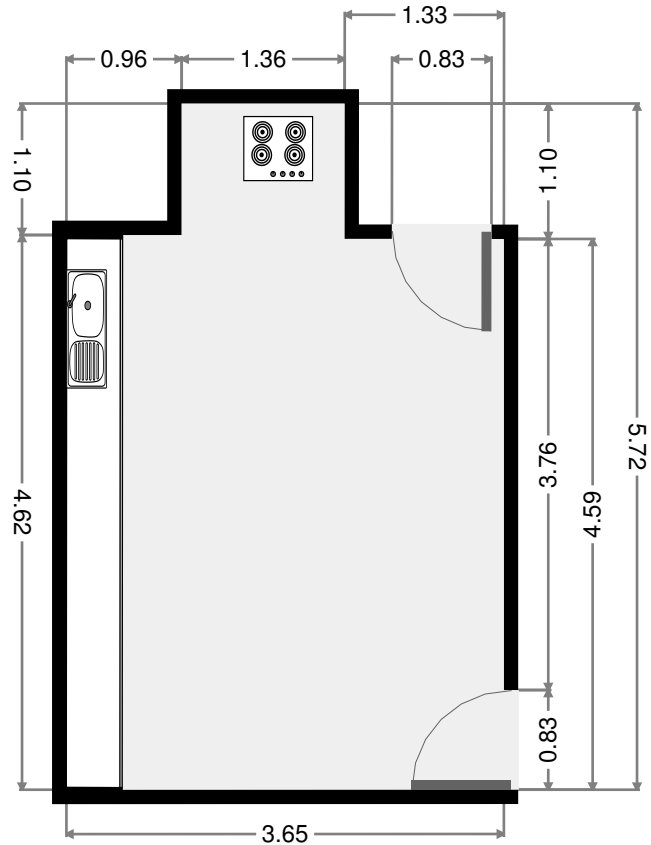
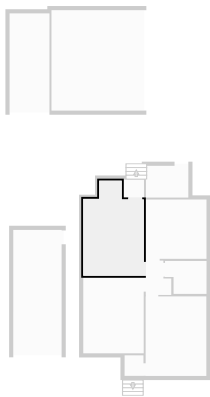

THIS FLOORPLAN IS PROVIDED WITHOUT WARRANTY OF ANY KIND. SENSOPIA DISCLAIMS ANY WARRANTY INCLUDING, WITHOUT LIMITATION, SATISFACTORY QUALITY OR ACCURACY OF DIMENSIONS.

- Width: 1.09 m
- Length: 1.22 m
- Area: 1.32 m<sup>2</sup>
- Perimeter: 4.61 m

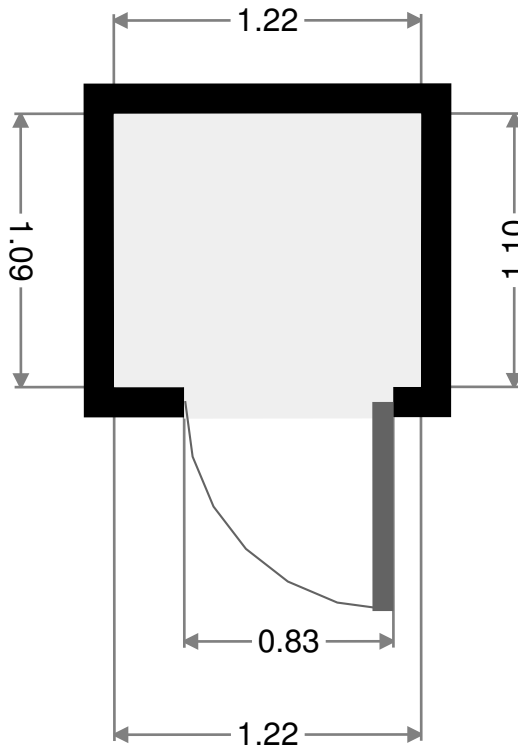
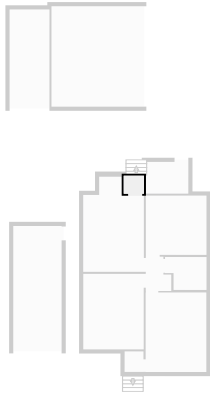

## Entry

- Width: 1.13 m
- Length: 1.23 m
- Area: 1.40 m<sup>2</sup>
- Perimeter: 4.73 m

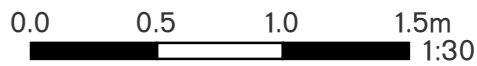
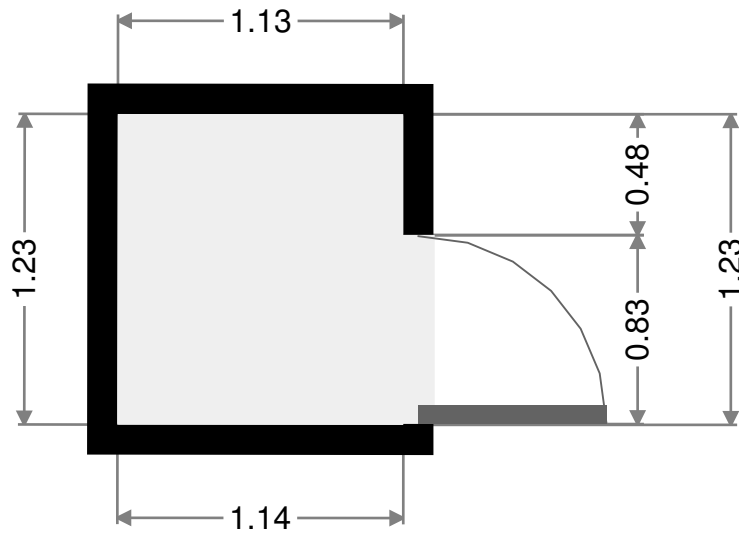

THIS FLOORPLAN IS PROVIDED WITHOUT WARRANTY OF ANY KIND. SENSOPIA DISCLAIMS ANY WARRANTY INCLUDING, WITHOUT LIMITATION, SATISFACTORY QUALITY OR ACCURACY OF DIMENSIONS.

# Laundry Room

Width: 1.91 m  
 Length: 2.55 m  
 Area: 4.86 m<sup>2</sup>  
 Perimeter: 8.91 m

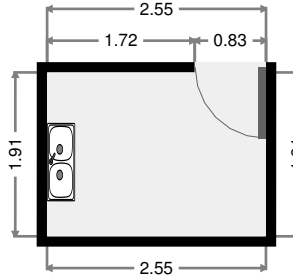

# Garage

Width: 2.91 m  
 Length: 7.41 m  
 Area: 21.54 m<sup>2</sup>  
 Perimeter: 20.64 m

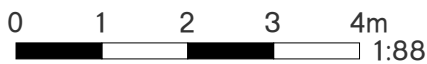
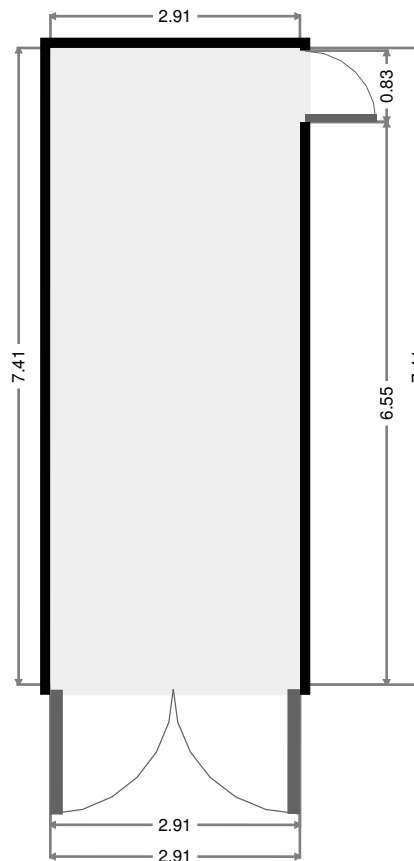
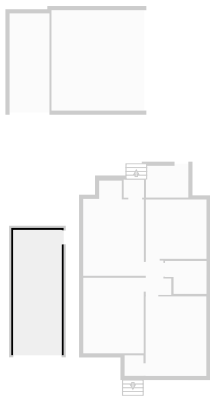

THIS FLOORPLAN IS PROVIDED WITHOUT WARRANTY OF ANY KIND. SENSOPIA DISCLAIMS ANY WARRANTY INCLUDING, WITHOUT LIMITATION, SATISFACTORY QUALITY OR ACCURACY OF DIMENSIONS.

# Shade Shed

Width: 5.46 m  
Length: 6.04 m  
Area: 32.94 m<sup>2</sup>  
Perimeter: 22.99 m

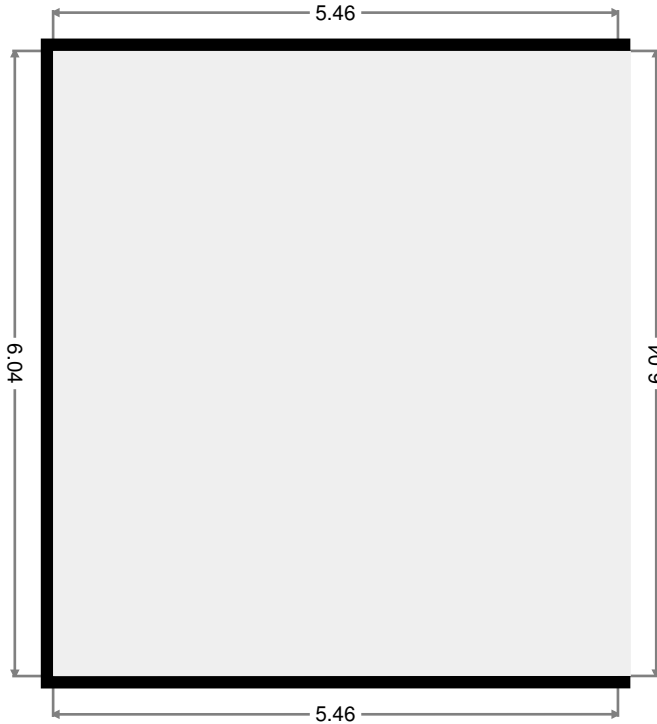

# Shipping Container

Width: 2.40 m  
Length: 5.84 m  
Area: 14.00 m<sup>2</sup>  
Perimeter: 16.47 m

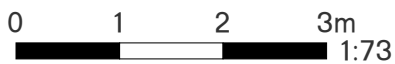
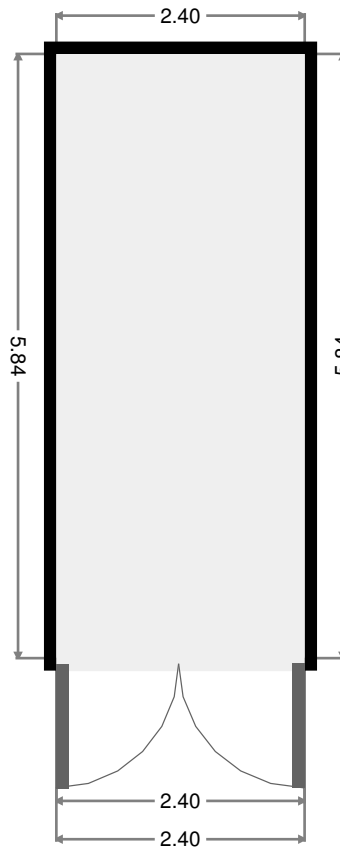
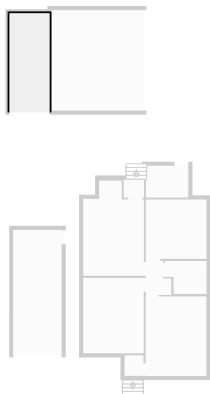

THIS FLOORPLAN IS PROVIDED WITHOUT WARRANTY OF ANY KIND. SENSOPIA DISCLAIMS ANY WARRANTY INCLUDING, WITHOUT LIMITATION, SATISFACTORY QUALITY OR ACCURACY OF DIMENSIONS.