

53 Denning Street

SUBMITTED BY
Janelle Casey

CREATED ON
2021-10-14

Floors
2

▼ Ground Floor



▼ **Garage**
Ground Floor

WIDTH: 6.79 m • LENGTH: 5.97 m
AREA: 38.10 m² • PERIMETER: 25.50 m

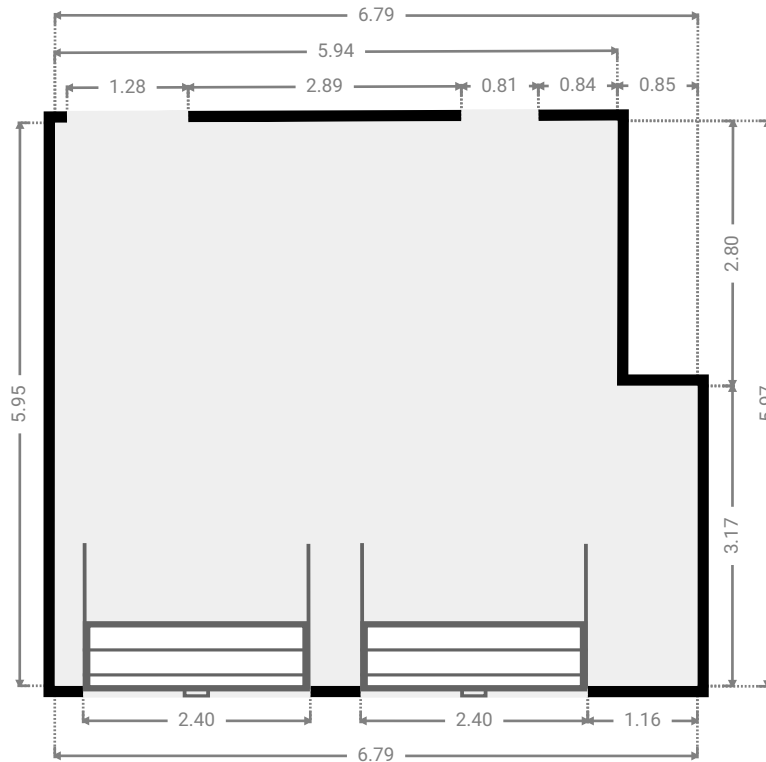
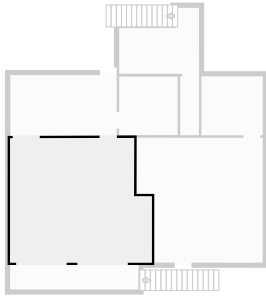

▼ **Laundry Room**
Ground Floor

WIDTH: 5.10 m • LENGTH: 2.93 m
AREA: 14.94 m² • PERIMETER: 16.06 m

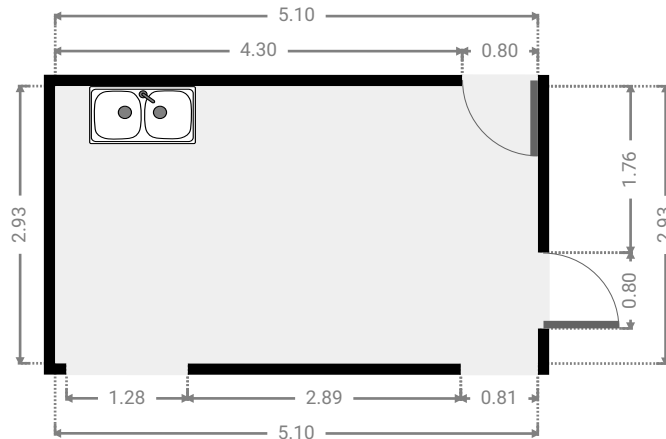
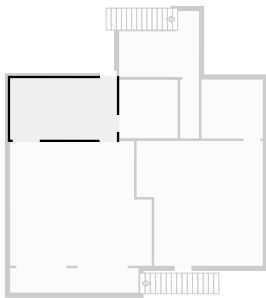

▼ **Storage**
Ground Floor

WIDTH: 2.80 m • LENGTH: 2.80 m
AREA: 7.85 m² • PERIMETER: 11.20 m

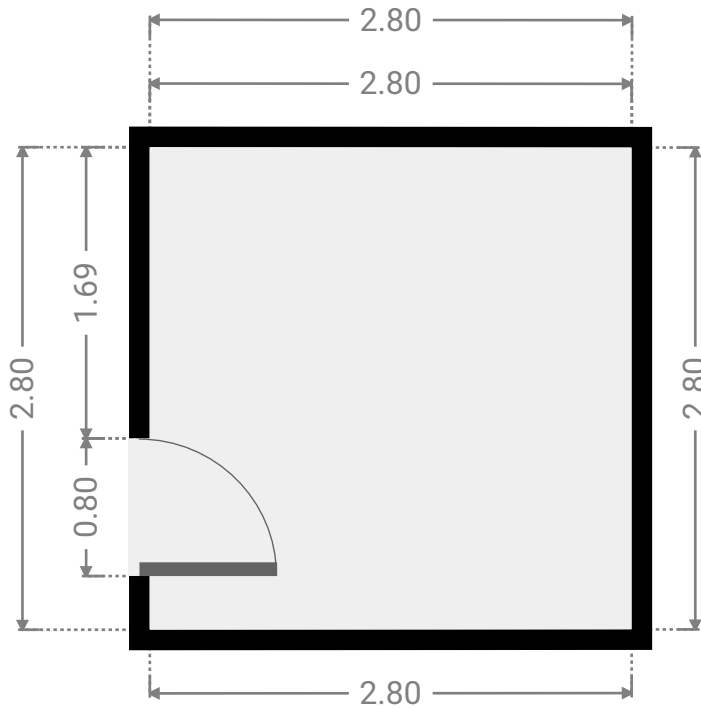
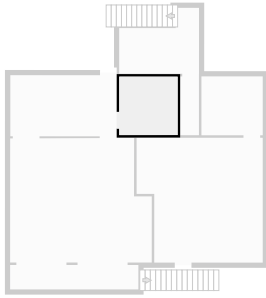

▼ **Toilet**
Ground Floor

WIDTH: 0.90 m • LENGTH: 2.79 m
AREA: 2.54 m² • PERIMETER: 7.44 m

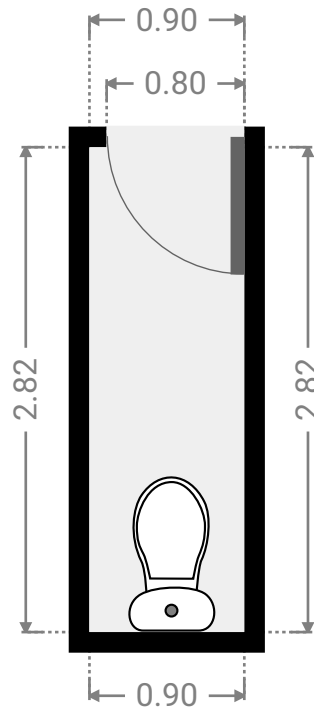
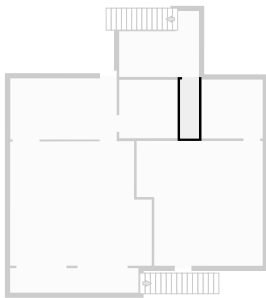

▼ **Living Room**
Ground Floor

WIDTH: 6.05 m • LENGTH: 5.99 m
AREA: 33.39 m² • PERIMETER: 24.06 m

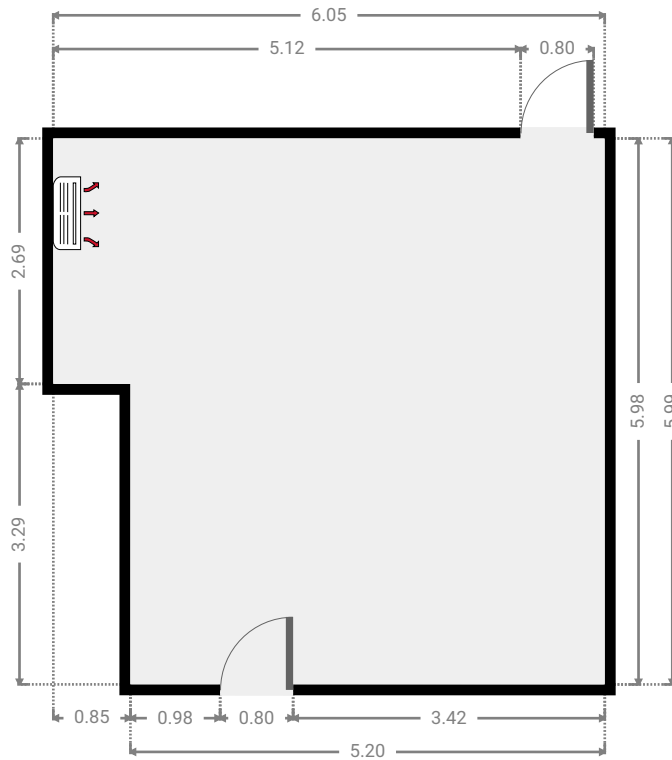
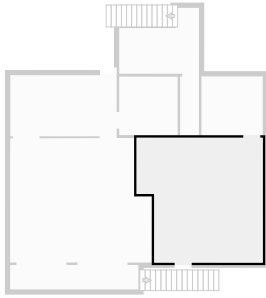

▼ **Additional Room**
Ground Floor

WIDTH: 2.94 m • LENGTH: 2.80 m
AREA: 8.29 m² • PERIMETER: 11.52 m

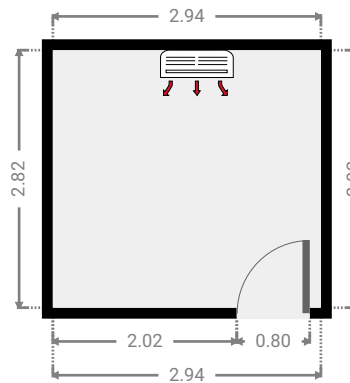
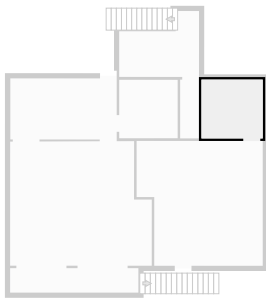

▼ Other
Ground Floor

WIDTH: 3.83 m • LENGTH: 3.16 m
AREA: 9.45 m² • PERIMETER: 13.97 m

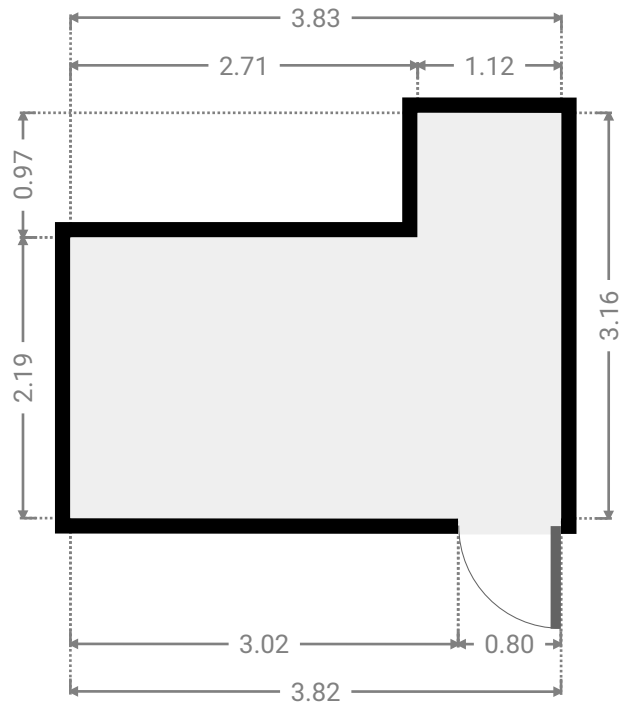
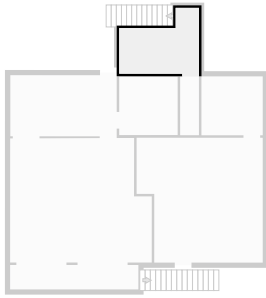

▼ Other
Ground Floor

WIDTH: 6.15 m • LENGTH: 1.17 m
AREA: 7.20 m² • PERIMETER: 14.64 m

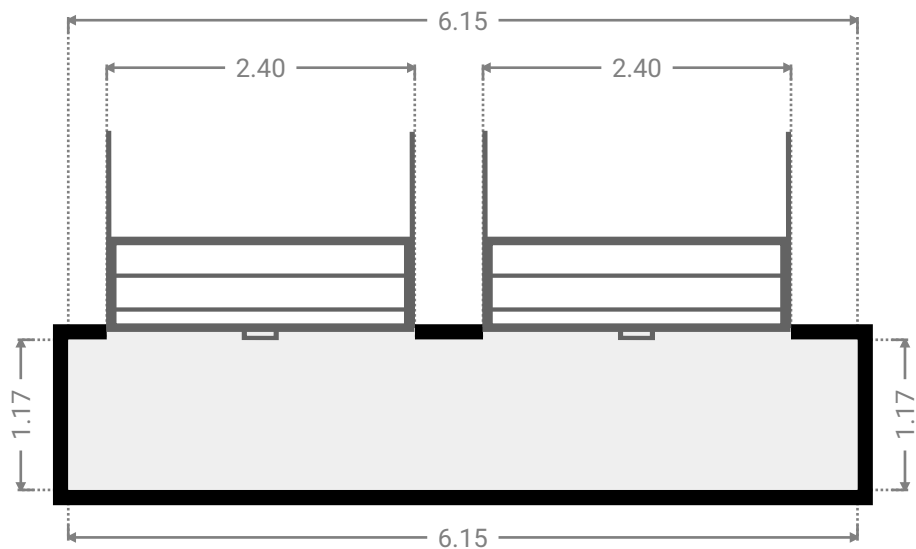
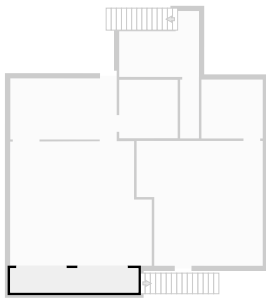

▼ 1st Floor

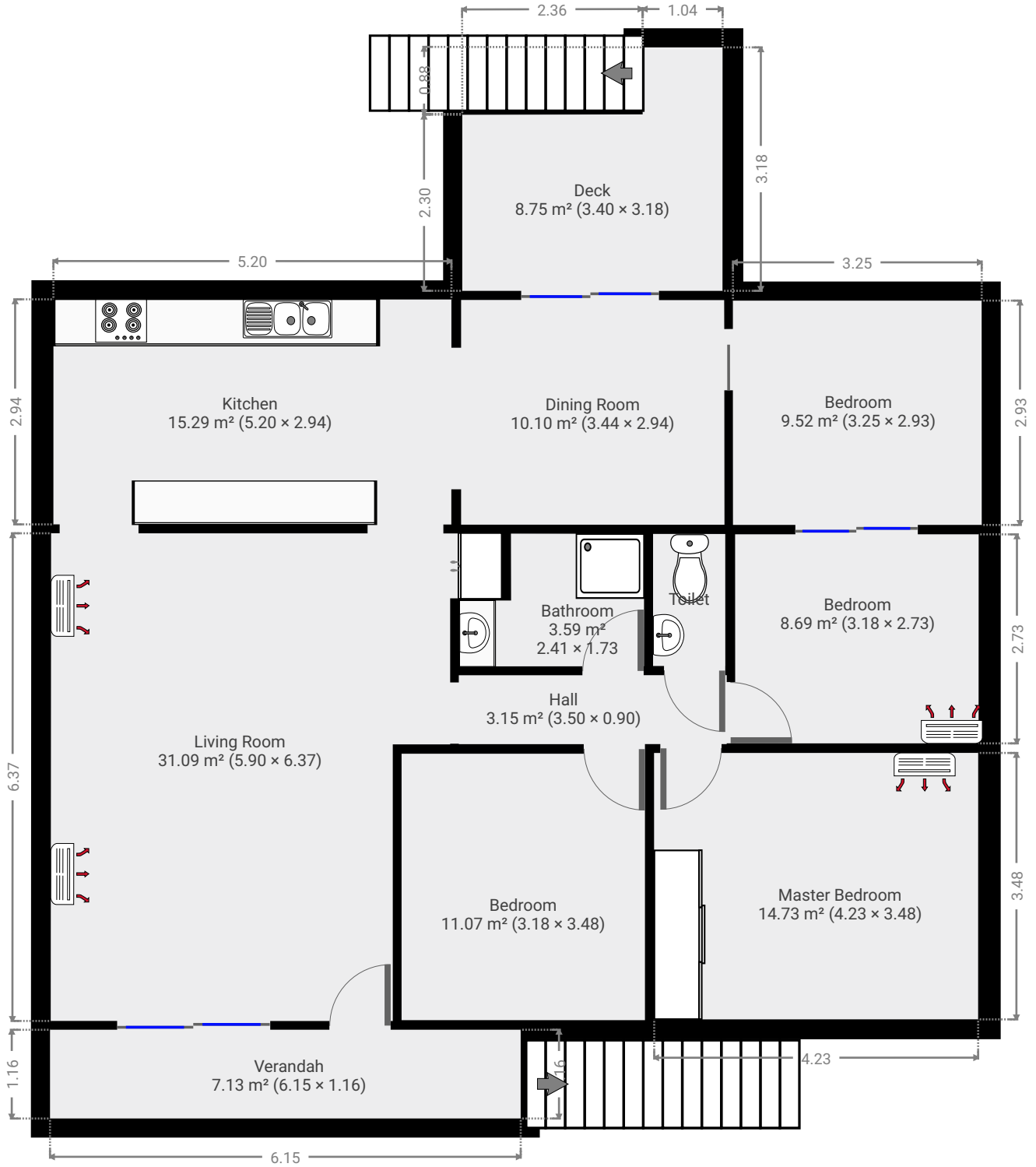

▼ Living Room
1st Floor

WIDTH: 5.90 m • LENGTH: 6.37 m
AREA: 31.09 m² • PERIMETER: 24.52 m

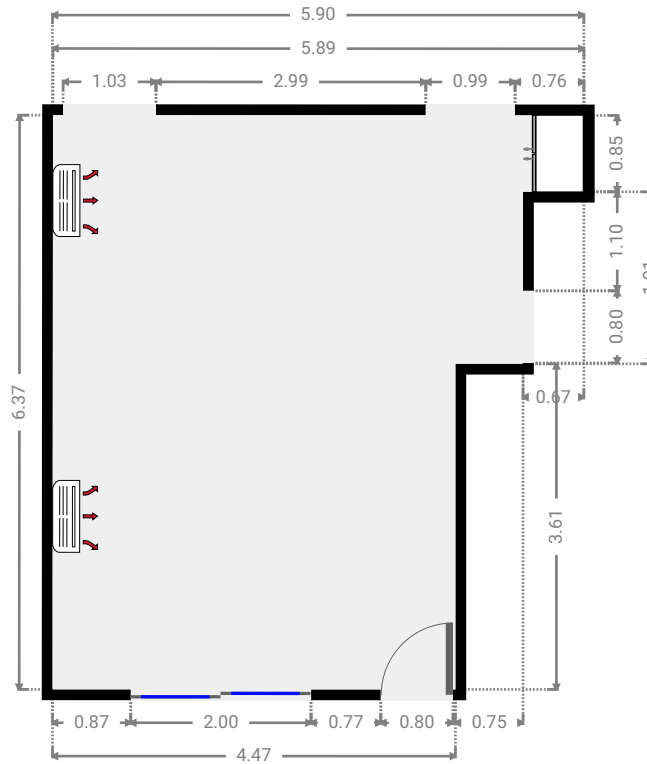
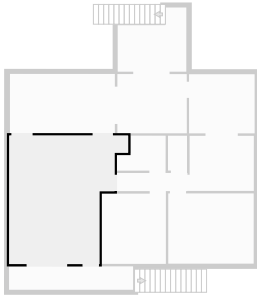

▼ Kitchen
1st Floor

WIDTH: 5.20 m • LENGTH: 2.94 m
AREA: 15.29 m² • PERIMETER: 16.28 m

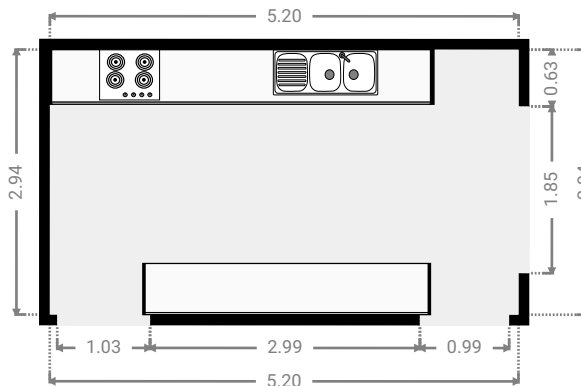
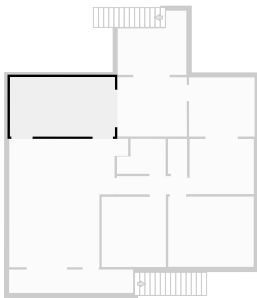

▼ **Hall**
1st Floor

WIDTH: 3.50 m • LENGTH: 0.90 m
AREA: 3.15 m² • PERIMETER: 8.80 m

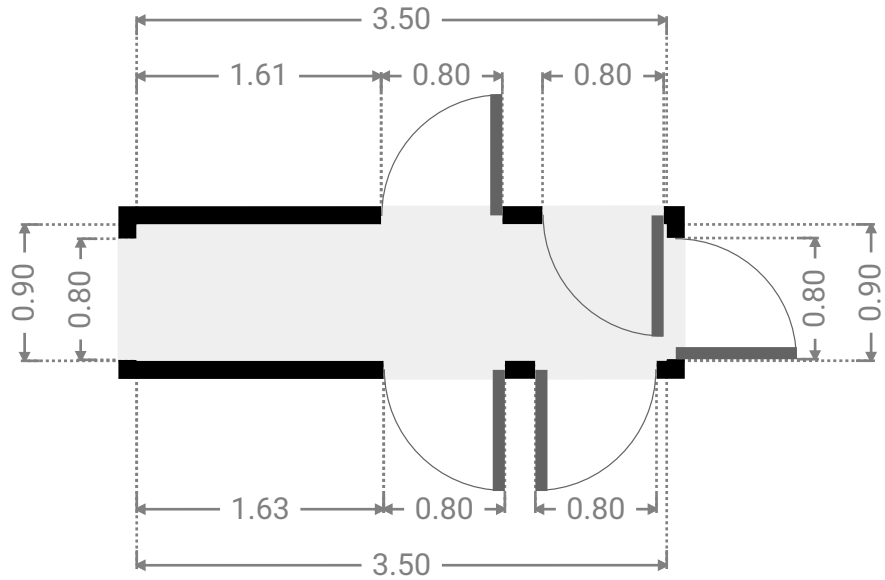
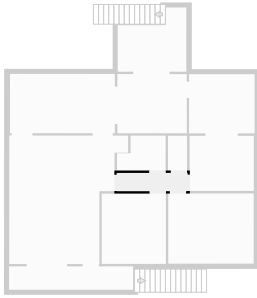

▼ **Bedroom**
1st Floor

WIDTH: 3.18 m • LENGTH: 3.48 m
AREA: 11.07 m² • PERIMETER: 13.32 m

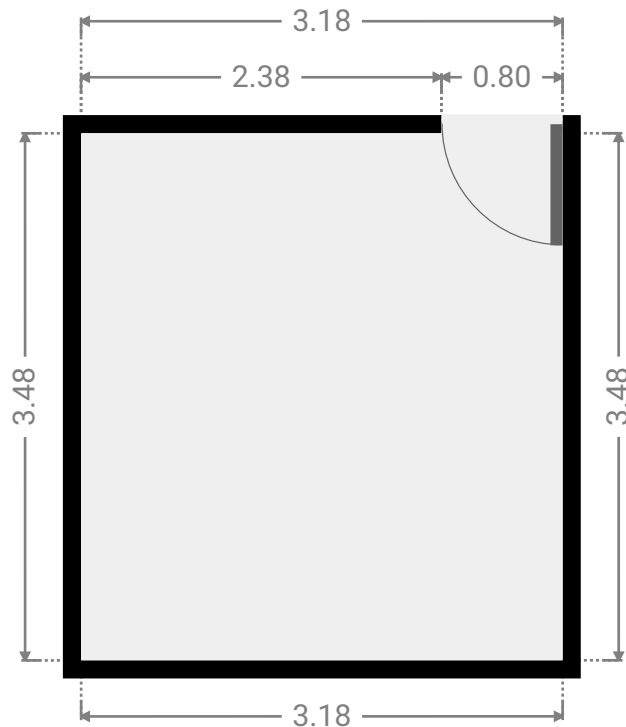
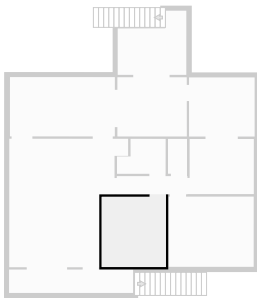

▼ **Bathroom**
1st Floor

WIDTH: 2.41 m • LENGTH: 1.73 m
AREA: 3.59 m² • PERIMETER: 8.29 m

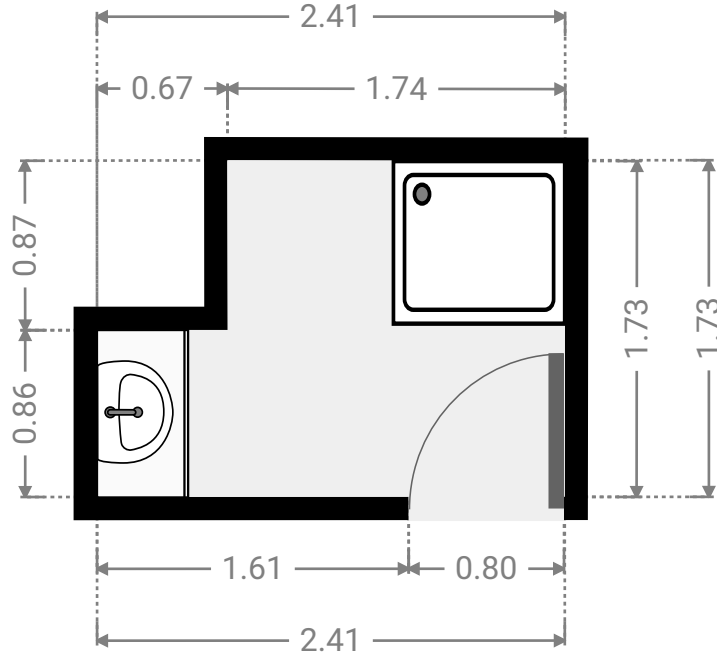
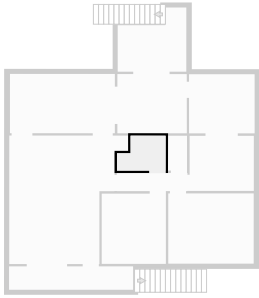

▼ **Toilet**
1st Floor

WIDTH: 0.94 m • LENGTH: 1.73 m
AREA: 1.63 m² • PERIMETER: 5.33 m

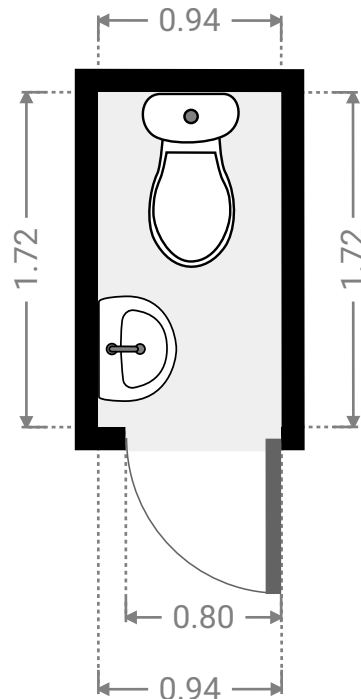
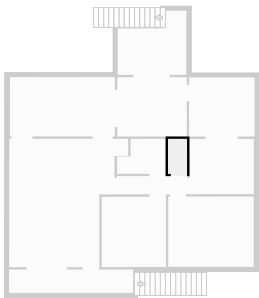

▼ **Bedroom**
1st Floor

WIDTH: 3.18 m • LENGTH: 2.73 m
AREA: 8.69 m² • PERIMETER: 11.82 m

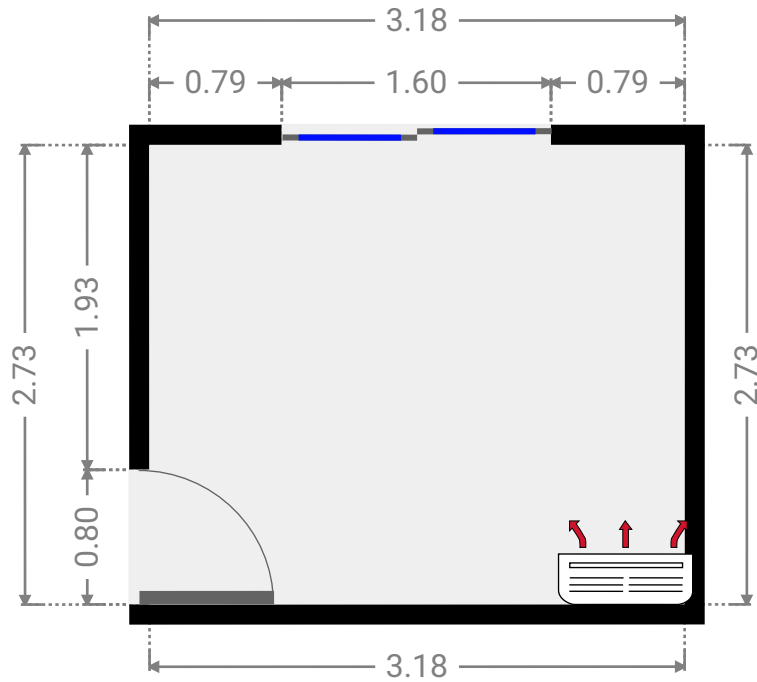
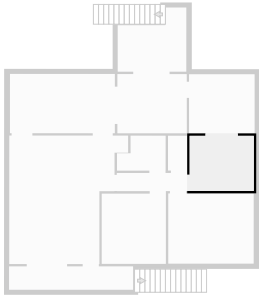

▼ **Bedroom**
1st Floor

WIDTH: 3.25 m • LENGTH: 2.93 m
AREA: 9.52 m² • PERIMETER: 12.36 m

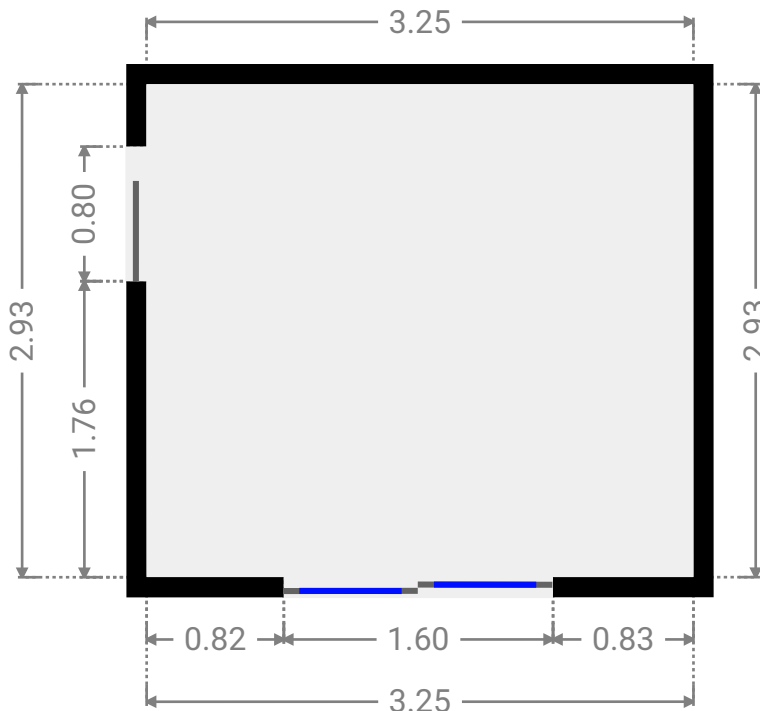
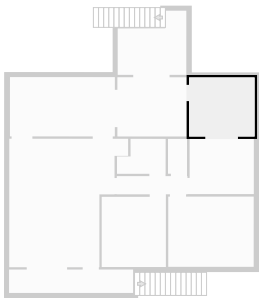

▼ **Dining Room**
1st Floor

WIDTH: 3.44 m • LENGTH: 2.94 m
AREA: 10.10 m² • PERIMETER: 12.75 m

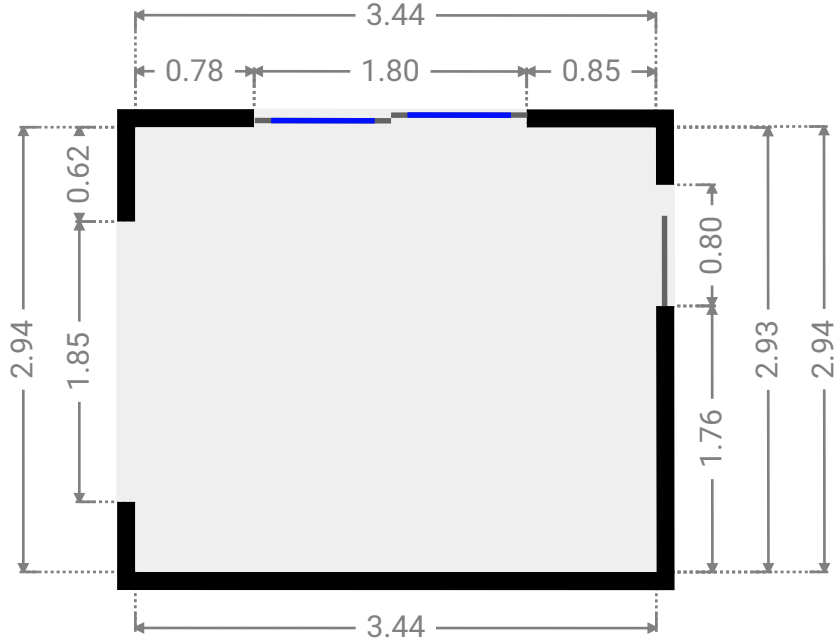
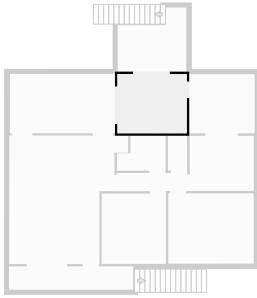

▼ **Master Bedroom**
1st Floor

WIDTH: 4.23 m • LENGTH: 3.48 m
AREA: 14.73 m² • PERIMETER: 15.43 m

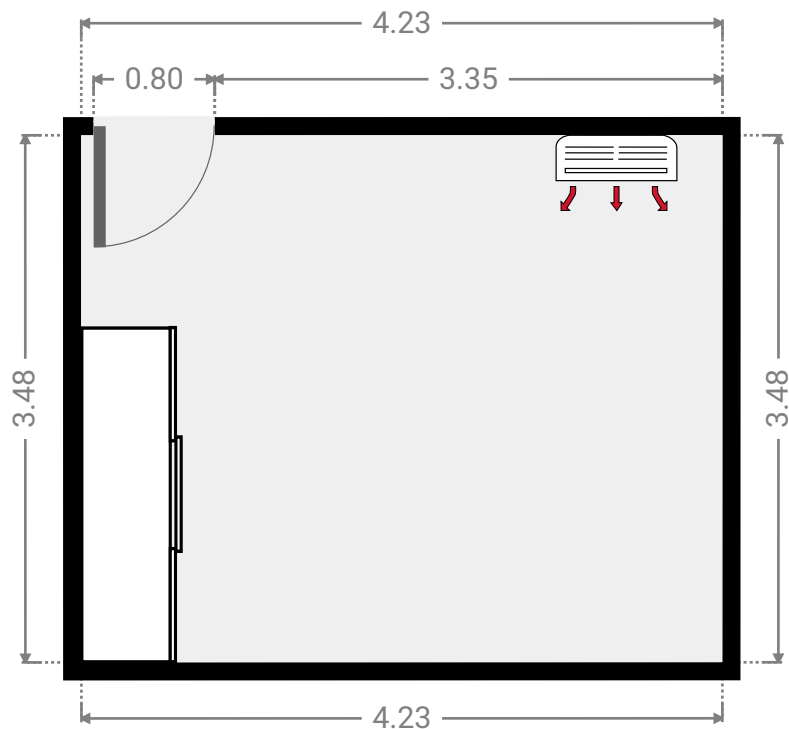
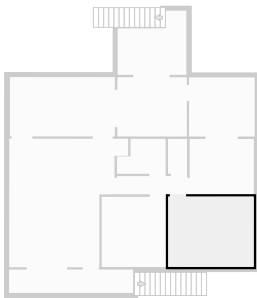

▼ **Deck**
1st Floor

WIDTH: 3.40 m • LENGTH: 3.18 m
AREA: 8.75 m² • PERIMETER: 13.15 m

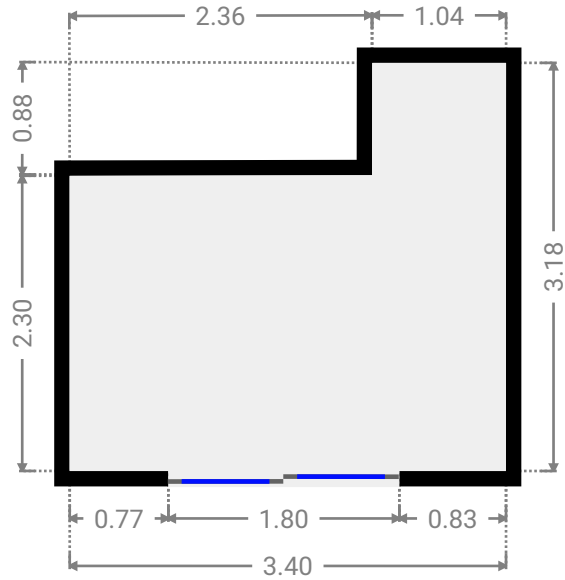
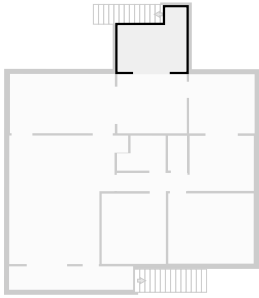

▼ **Verandah**
1st Floor

WIDTH: 6.15 m • LENGTH: 1.16 m
AREA: 7.13 m² • PERIMETER: 14.62 m

