

51 Peppermint Drive

SUBMITTED BY
Janelle Casey

CREATED ON
2021-10-21

Floors 1

▼ Ground Floor

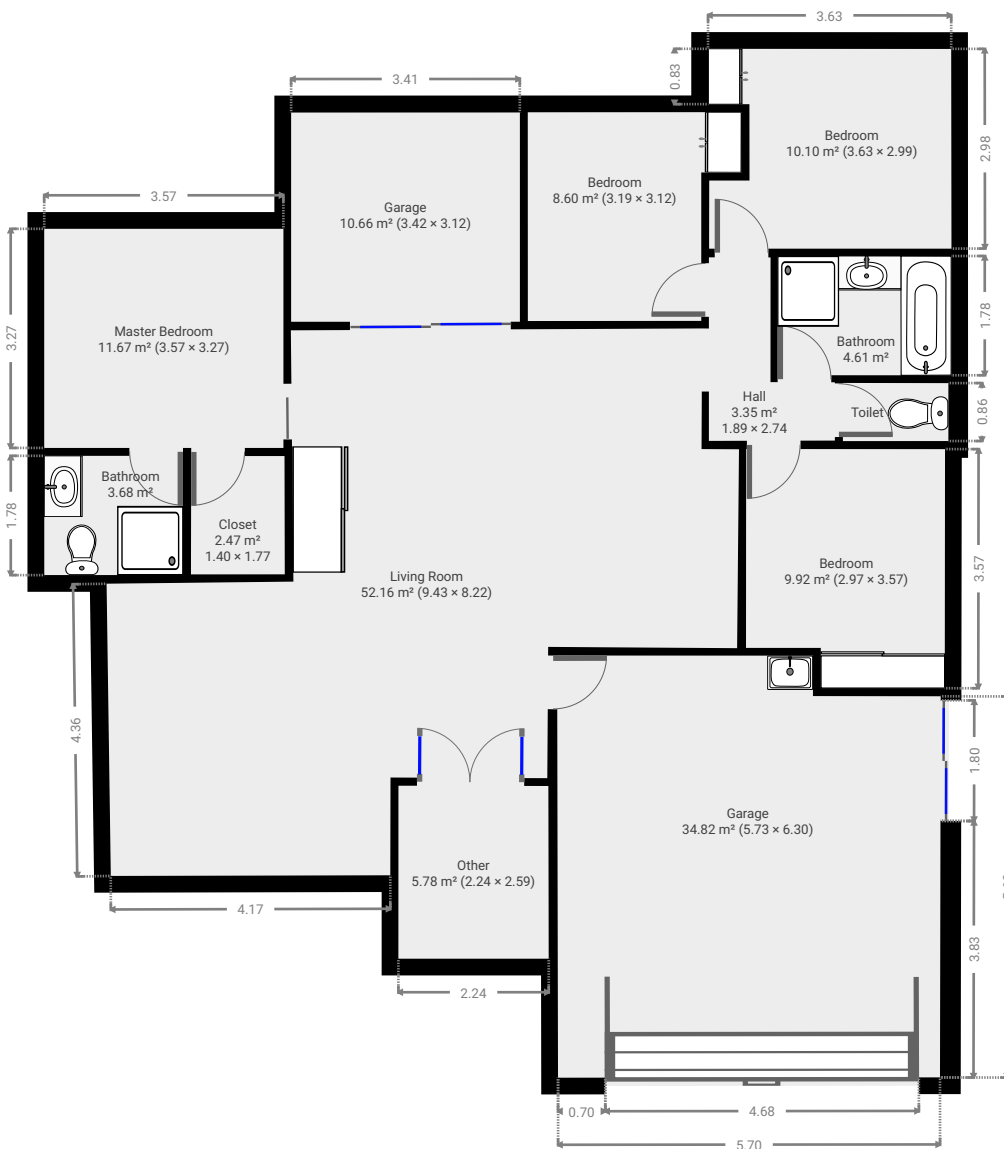
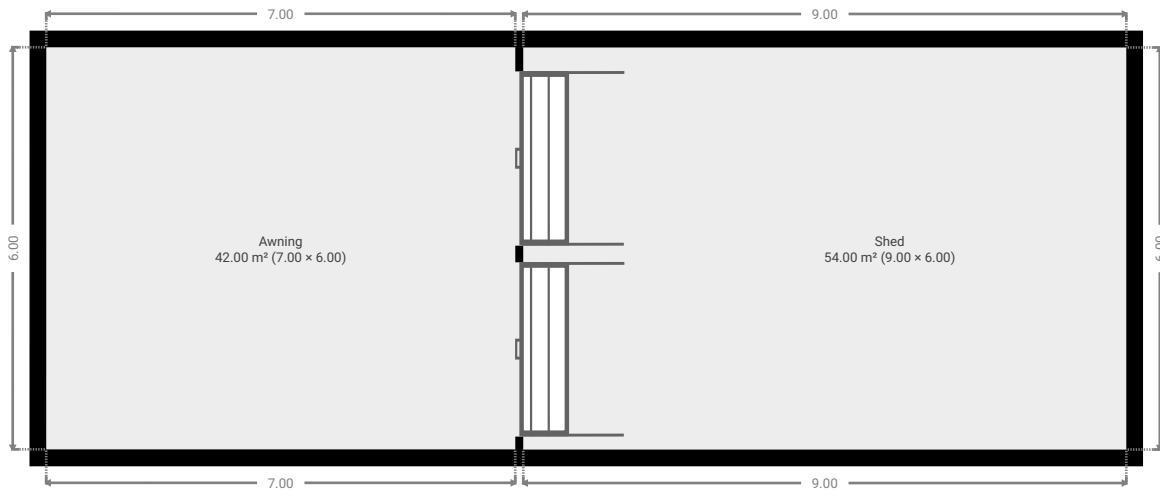

FLOORS: 1

▼ Living Room Ground Floor

WIDTH: 9.43 m • LENGTH: 8.22 m
AREA: 52.16 m² • PERIMETER: 35.12 m

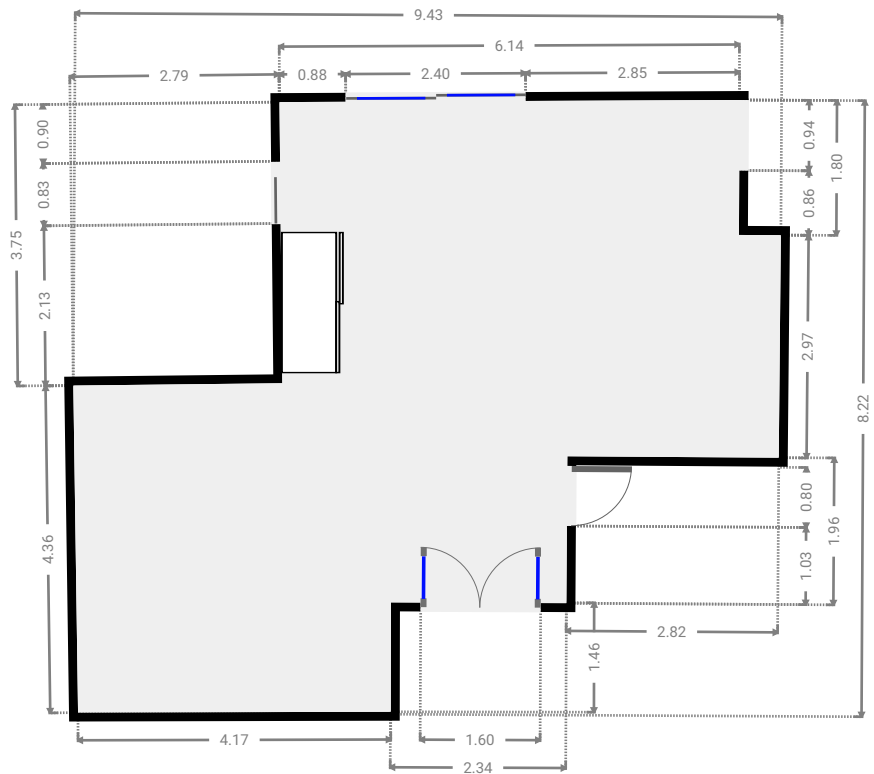
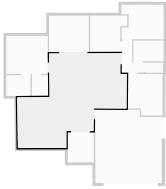

▼ Master Bedroom Ground Floor

WIDTH: 3.57 m • LENGTH: 3.27 m
AREA: 11.67 m² • PERIMETER: 13.68 m

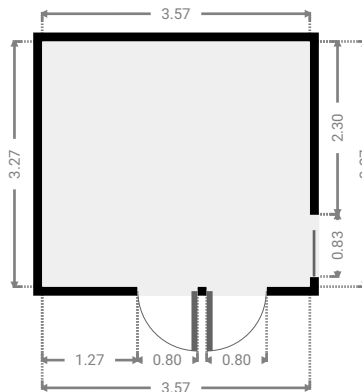
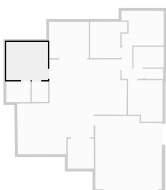

FLOORS: 1

▼ Bathroom
Ground Floor

WIDTH: 2.07 m • LENGTH: 1.78 m
AREA: 3.68 m² • PERIMETER: 7.70 m

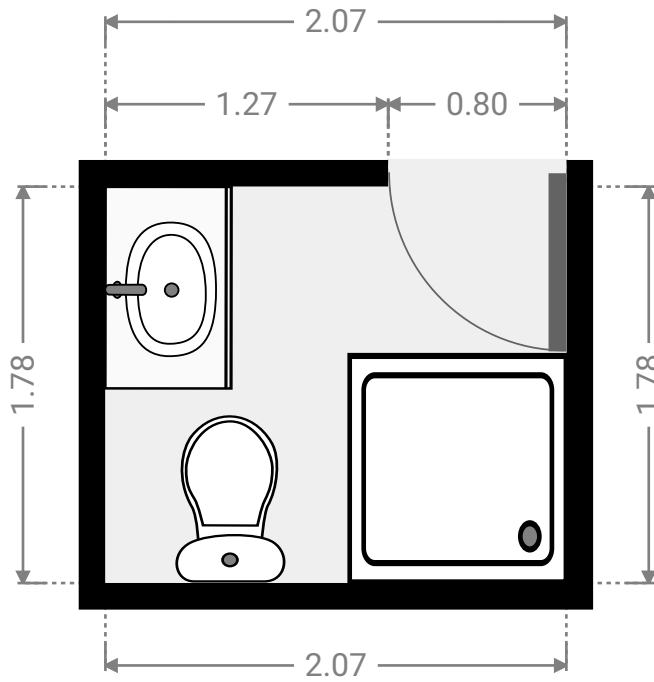
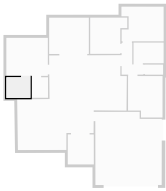

▼ Closet
Ground Floor

WIDTH: 1.40 m • LENGTH: 1.77 m
AREA: 2.47 m² • PERIMETER: 6.33 m

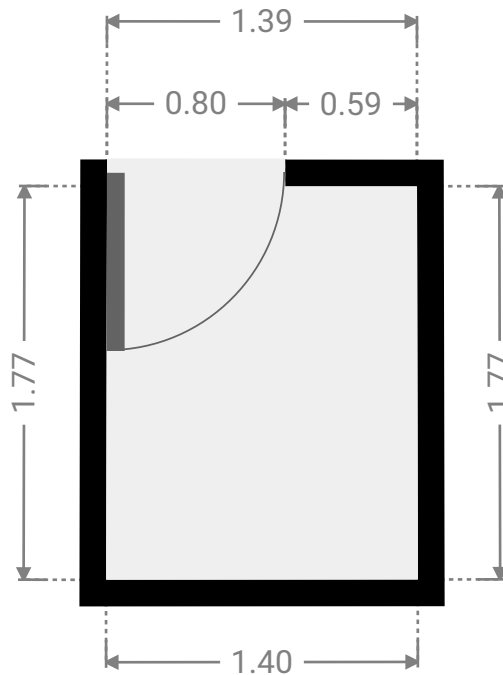
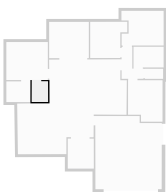

FLOORS: 1

▼ Hall Ground Floor

WIDTH: 1.89 m • LENGTH: 2.74 m
AREA: 3.35 m² • PERIMETER: 9.23 m

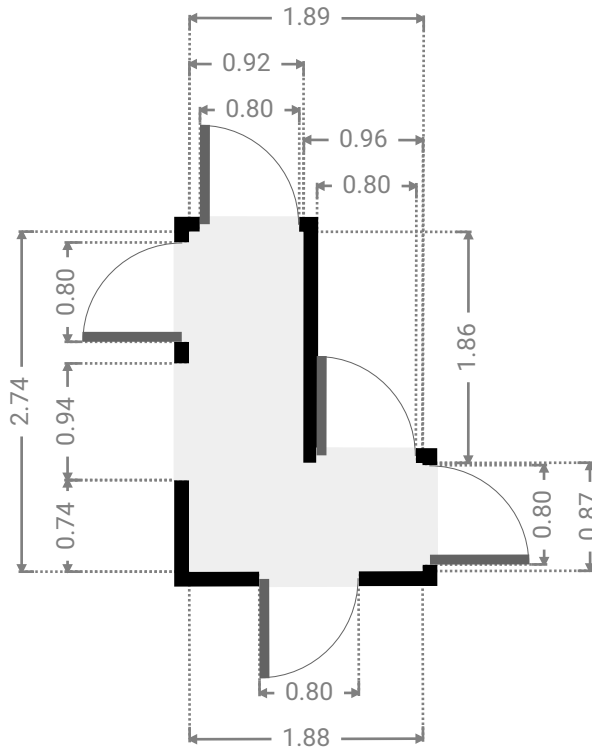
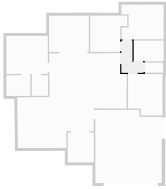

▼ Bedroom Ground Floor

WIDTH: 2.97 m • LENGTH: 3.57 m
AREA: 9.92 m² • PERIMETER: 13.07 m

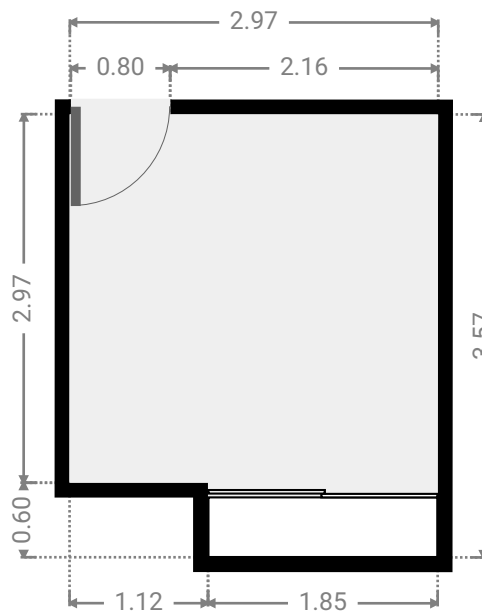
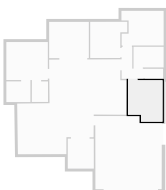

FLOORS: 1

▼ Toilet
Ground Floor

WIDTH: 1.57 m • LENGTH: 0.87 m
AREA: 1.36 m² • PERIMETER: 4.88 m

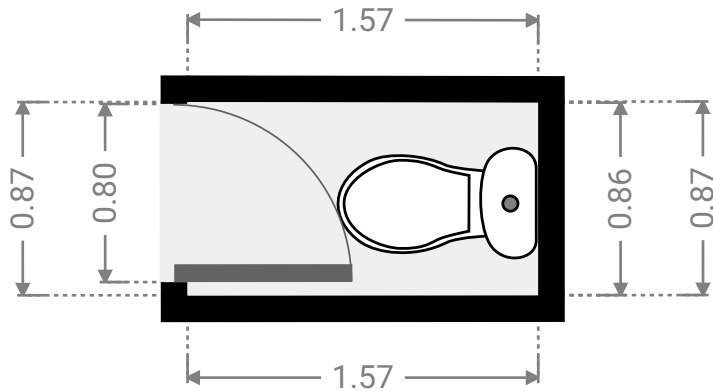
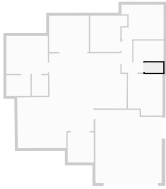

▼ Bathroom
Ground Floor

WIDTH: 2.59 m • LENGTH: 1.78 m
AREA: 4.61 m² • PERIMETER: 8.74 m

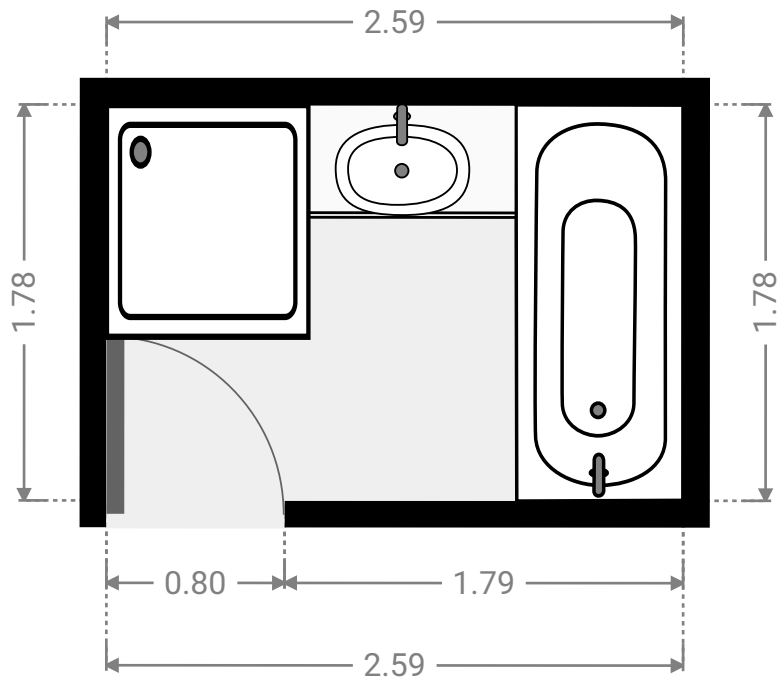
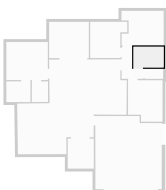

FLOORS: 1

▼ **Bedroom**
Ground Floor

WIDTH: 3.19 m • LENGTH: 3.12 m
AREA: 8.60 m² • PERIMETER: 12.61 m

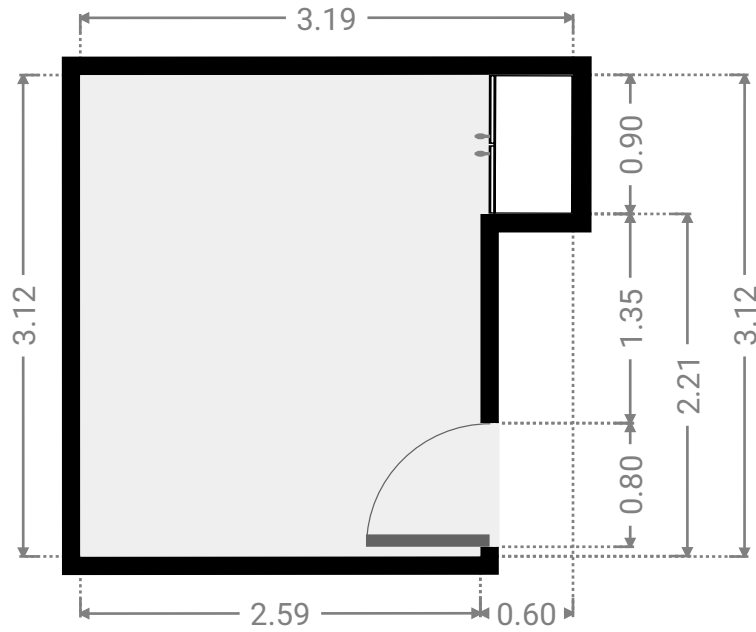
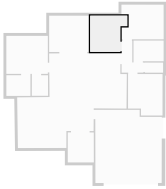

▼ **Bedroom**
Ground Floor

WIDTH: 3.63 m • LENGTH: 2.99 m
AREA: 10.10 m² • PERIMETER: 14.43 m

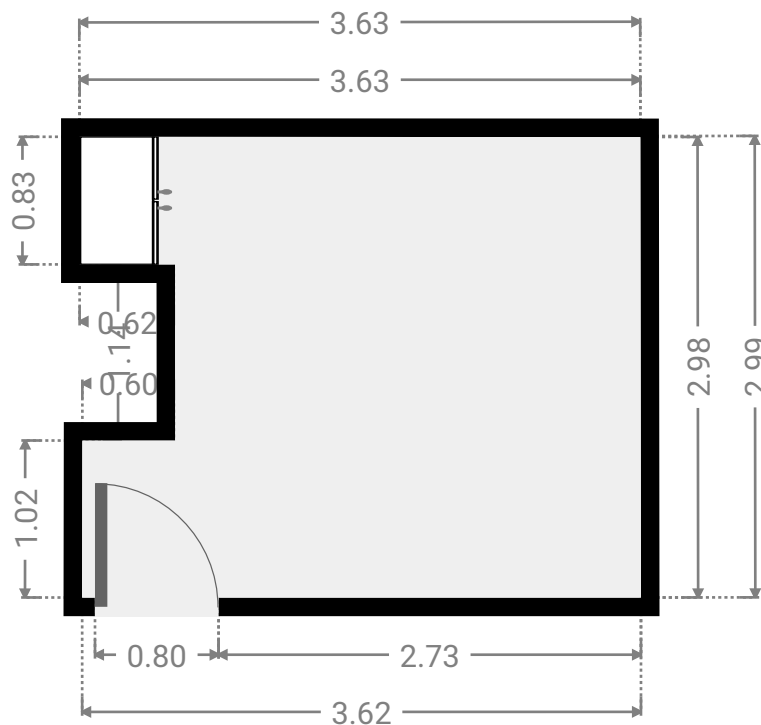
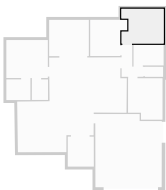

FLOORS: 1

▼ Garage Ground Floor

WIDTH: 3.42 m • LENGTH: 3.12 m
AREA: 10.66 m² • PERIMETER: 13.07 m

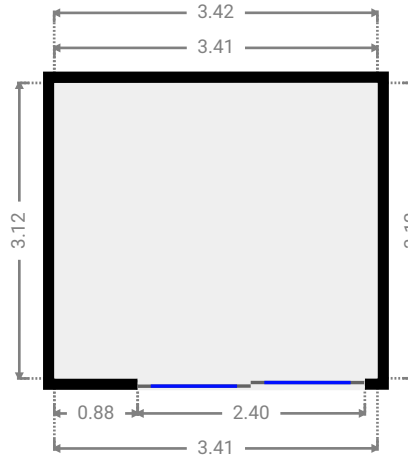
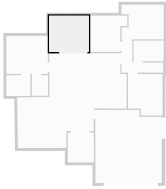

▼ Garage Ground Floor

WIDTH: 5.73 m • LENGTH: 6.30 m
AREA: 34.82 m² • PERIMETER: 24.02 m

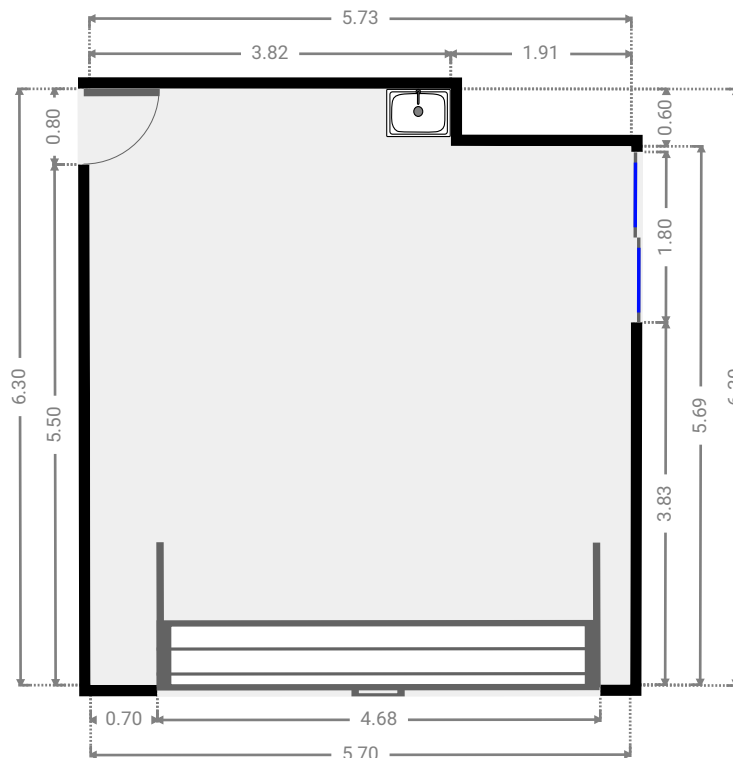
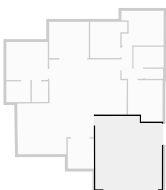

▼ Awning Ground Floor

WIDTH: 7.00 m • LENGTH: 6.00 m
AREA: 42.00 m² • PERIMETER: 26.00 m

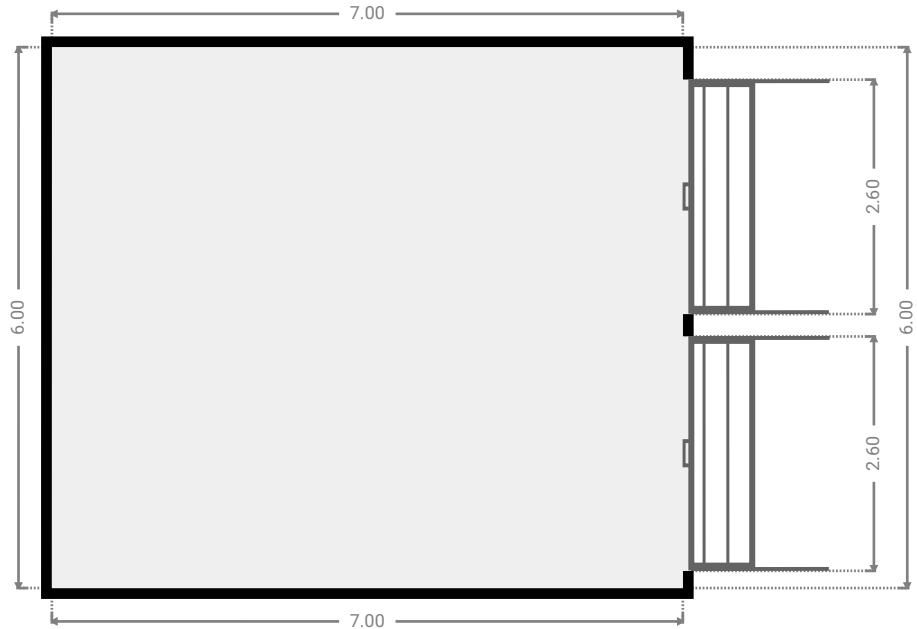
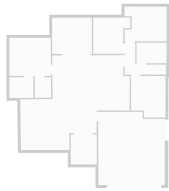

▼ Shed Ground Floor

WIDTH: 9.00 m • LENGTH: 6.00 m
AREA: 54.00 m² • PERIMETER: 30.00 m

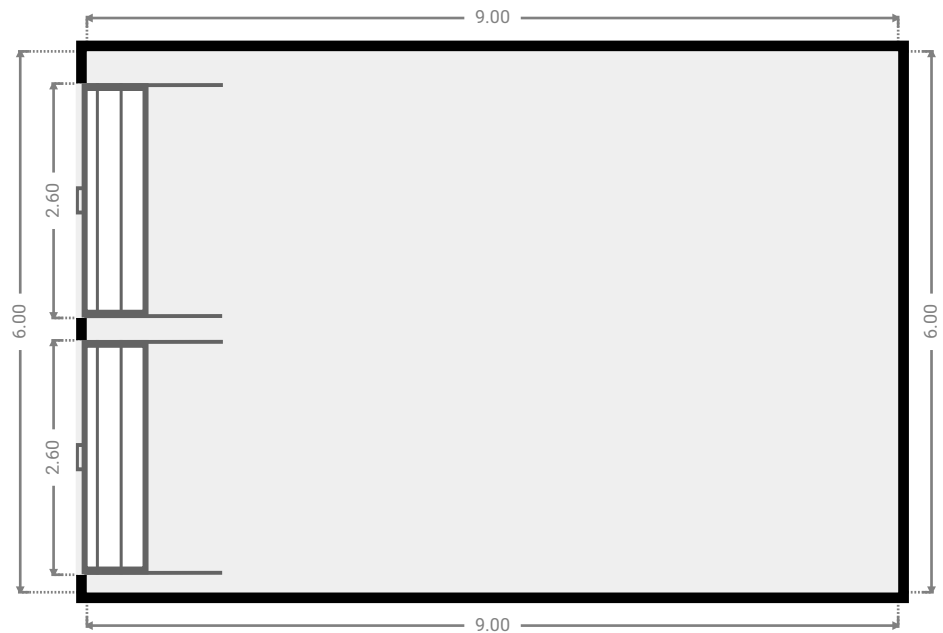

51 Peppermint Drive

FLOORS: 1

▼ Other Ground Floor

WIDTH: 2.24 m • LENGTH: 2.59 m
AREA: 5.78 m² • PERIMETER: 9.64 m

