

# 5 Virginia Court

## Ground Floor

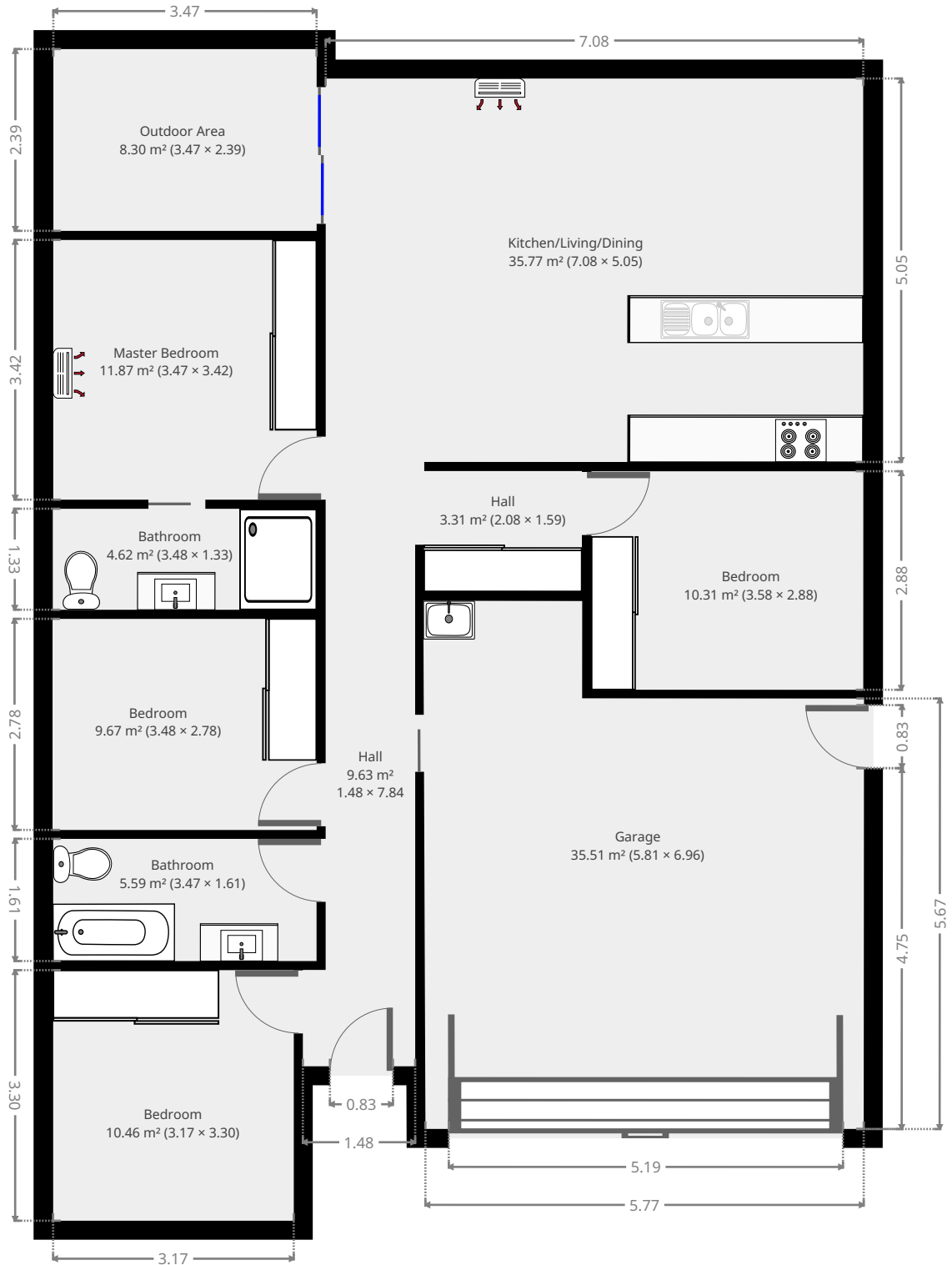

THIS FLOORPLAN IS PROVIDED WITHOUT WARRANTY OF ANY KIND. SENSOPIA DISCLAIMS ANY WARRANTY INCLUDING, WITHOUT LIMITATION, SATISFACTORY QUALITY OR ACCURACY OF DIMENSIONS.

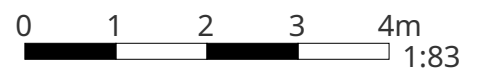

# 5 Virginia Court

## Hall

Width: 1.48 m  
 Length: 7.84 m  
 Area: 9.63 m<sup>2</sup>  
 Perimeter: 18.64 m

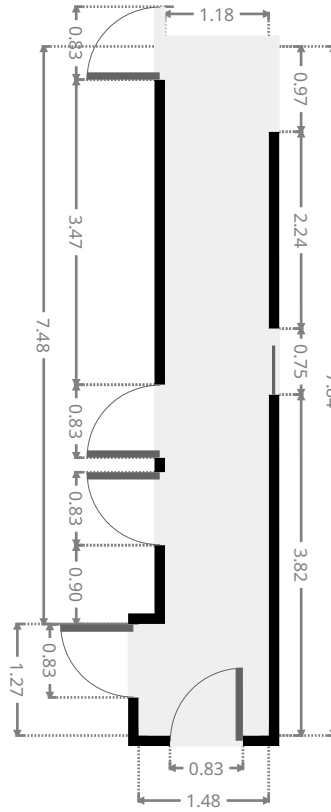
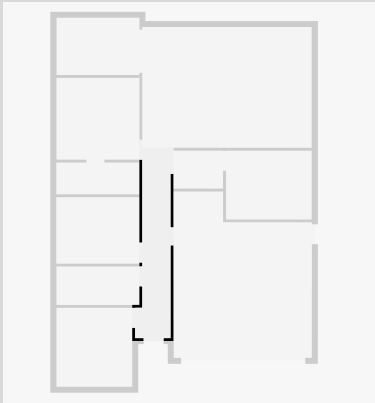

## Bedroom

Width: 3.17 m  
 Length: 3.30 m  
 Area: 10.46 m<sup>2</sup>  
 Perimeter: 12.94 m

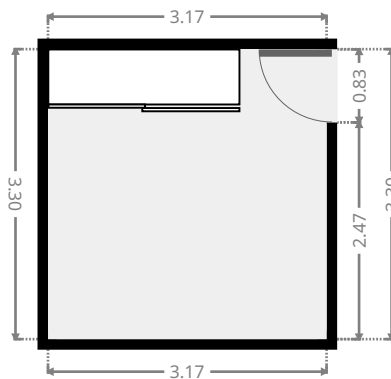
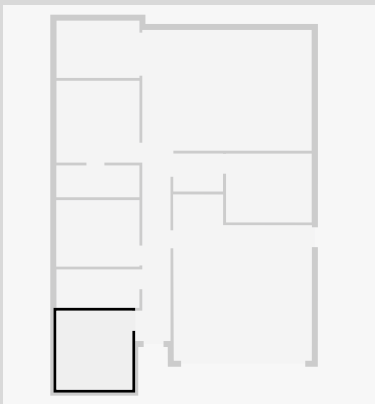

# 5 Virginia Court

## Bathroom

Width: 1.61 m  
Length: 3.47 m  
Area: 5.59 m<sup>2</sup>  
Perimeter: 10.16 m

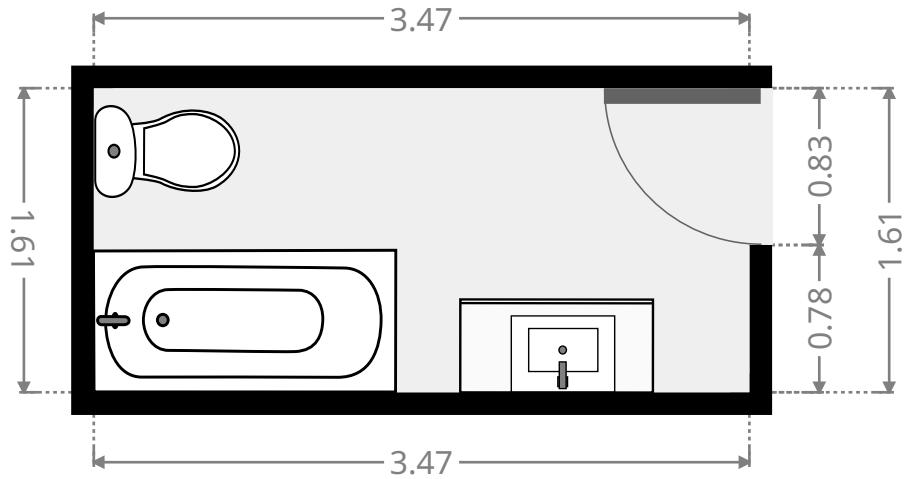
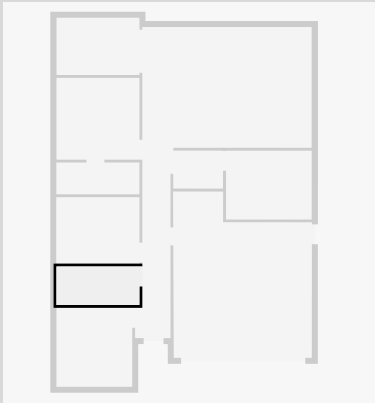

## Bedroom

Width: 2.78 m  
Length: 3.48 m  
Area: 9.67 m<sup>2</sup>  
Perimeter: 12.52 m

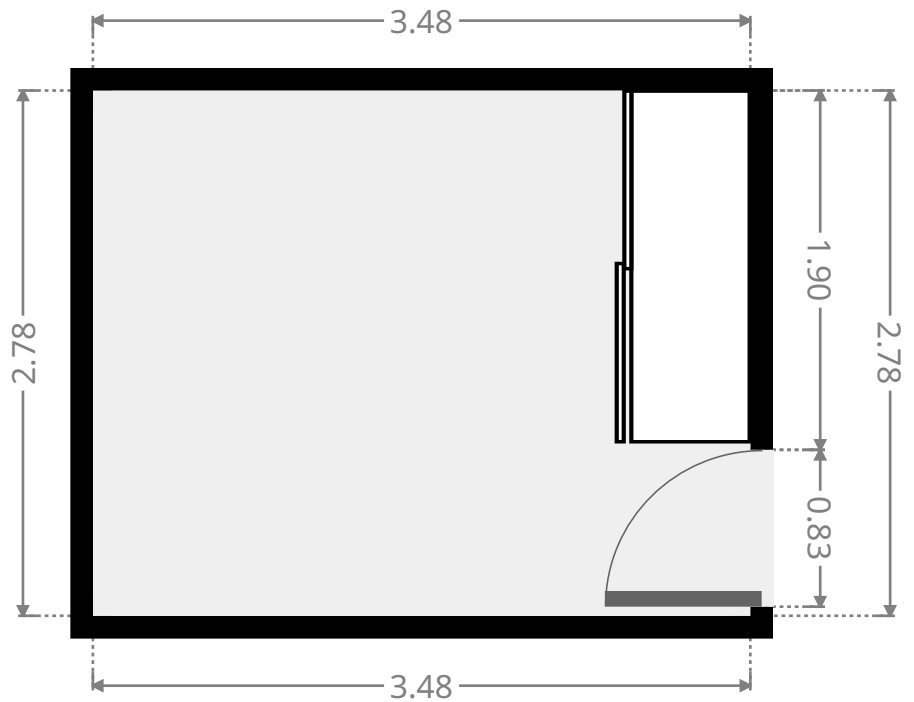
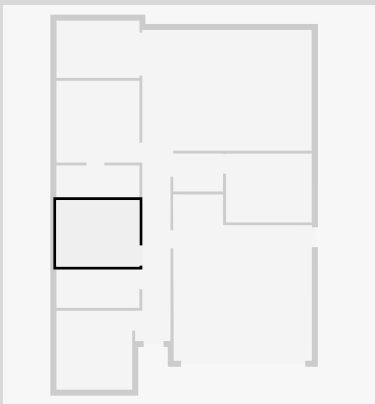

THIS FLOORPLAN IS PROVIDED WITHOUT WARRANTY OF ANY KIND. SENSOPIA DISCLAIMS ANY WARRANTY INCLUDING, WITHOUT LIMITATION, SATISFACTORY QUALITY OR ACCURACY OF DIMENSIONS.

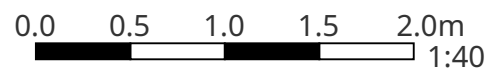

# 5 Virginia Court

## Garage

Width: 5.81 m  
Length: 6.96 m  
Area: 35.51 m<sup>2</sup>  
Perimeter: 25.49 m

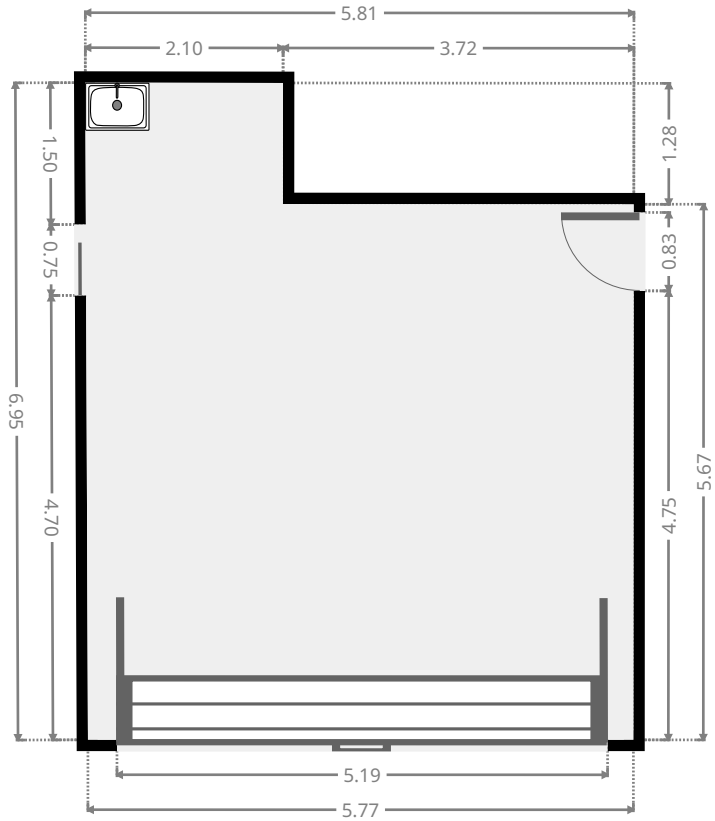
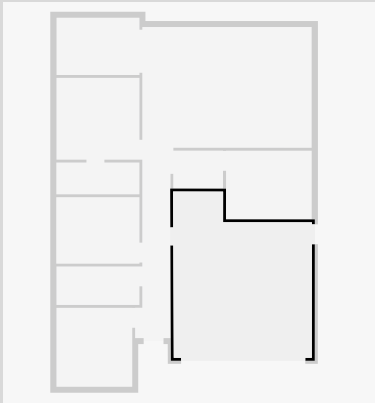

## Hall

Width: 1.59 m  
Length: 2.08 m  
Area: 3.31 m<sup>2</sup>  
Perimeter: 7.34 m

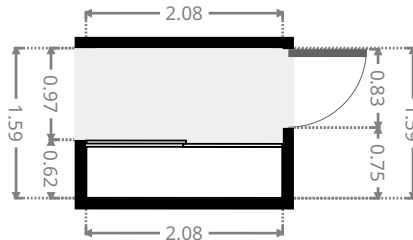
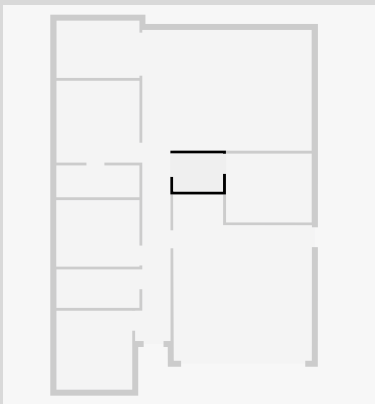

# 5 Virginia Court

## Bedroom

Width: 2.88 m  
 Length: 3.58 m  
 Area: 10.31 m<sup>2</sup>  
 Perimeter: 12.92 m

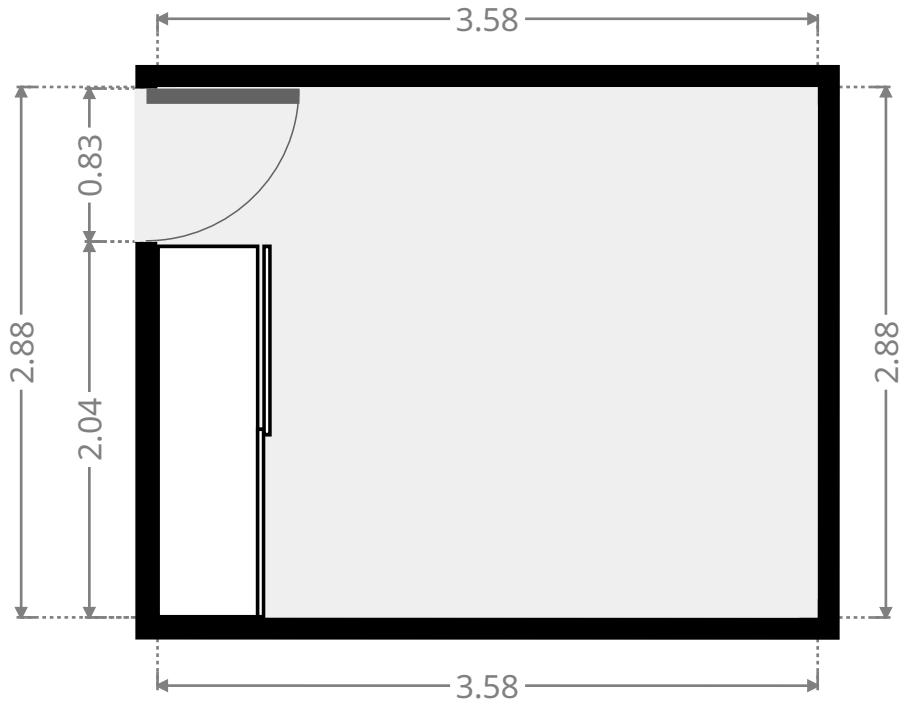
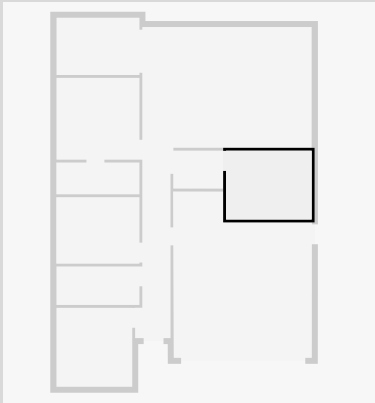

## Bathroom

Width: 1.33 m  
 Length: 3.48 m  
 Area: 4.62 m<sup>2</sup>  
 Perimeter: 9.61 m

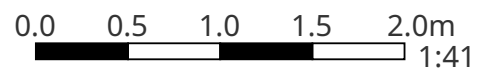
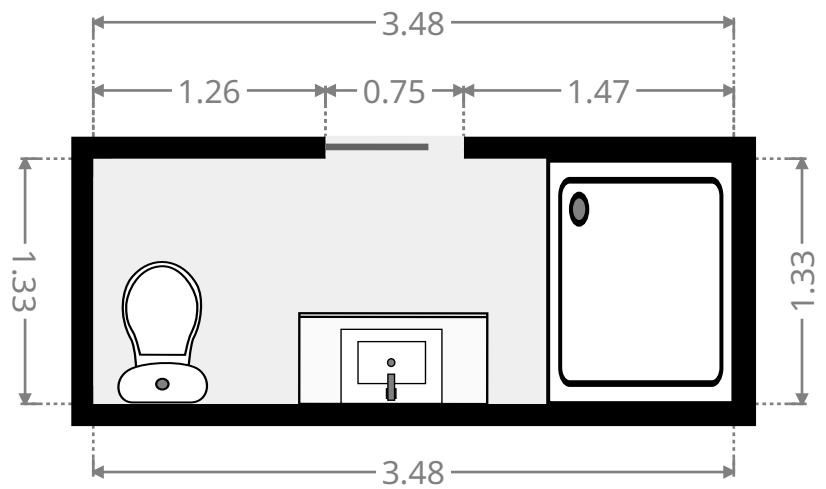
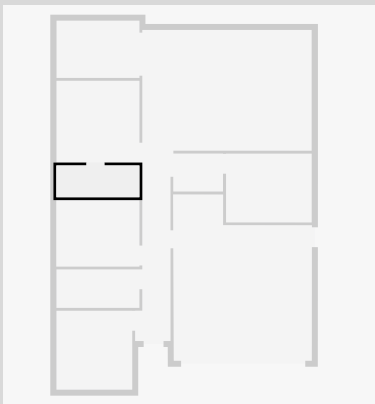

# 5 Virginia Court

## Master Bedroom

Width: 3.42 m  
 Length: 3.47 m  
 Area: 11.87 m<sup>2</sup>  
 Perimeter: 13.78 m

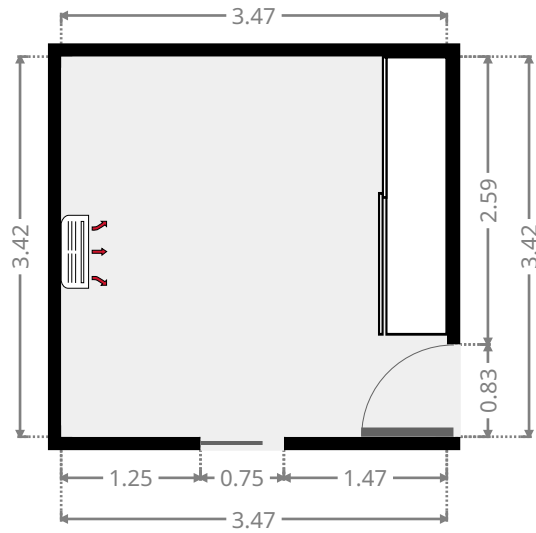
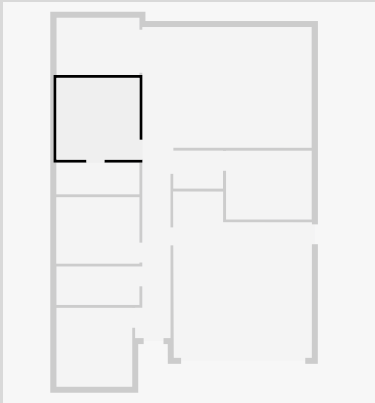

## Kitchen/Living/Dining

Width: 5.05 m  
 Length: 7.08 m  
 Area: 35.77 m<sup>2</sup>  
 Perimeter: 24.27 m

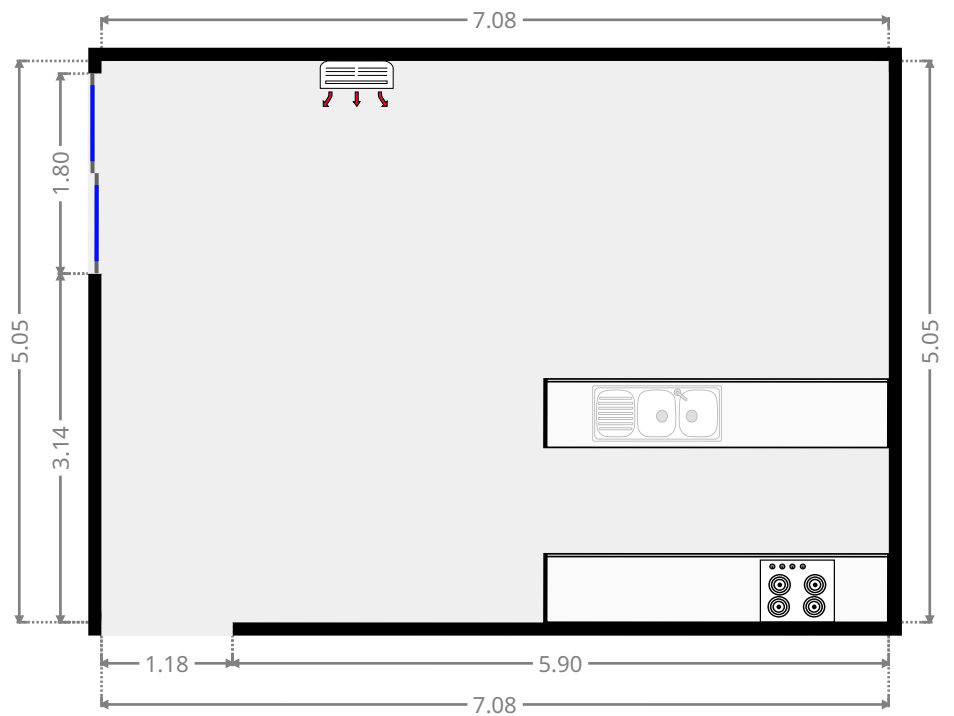
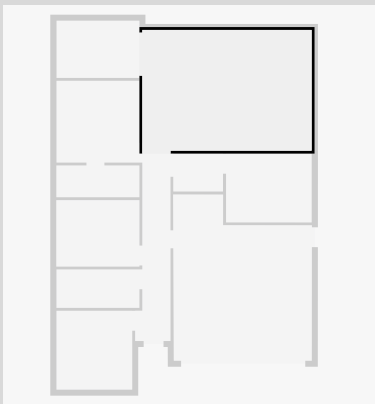

THIS FLOORPLAN IS PROVIDED WITHOUT WARRANTY OF ANY KIND. SENSOPIA DISCLAIMS ANY WARRANTY INCLUDING, WITHOUT LIMITATION, SATISFACTORY QUALITY OR ACCURACY OF DIMENSIONS.

# 5 Virginia Court

## Outdoor Area

Width: 2.39 m  
Length: 3.47 m  
Area: 8.30 m<sup>2</sup>  
Perimeter: 11.72 m

