

5 Tomtitt Avenue

Created on
2021-01-25

Floors
1

▼ Ground Floor

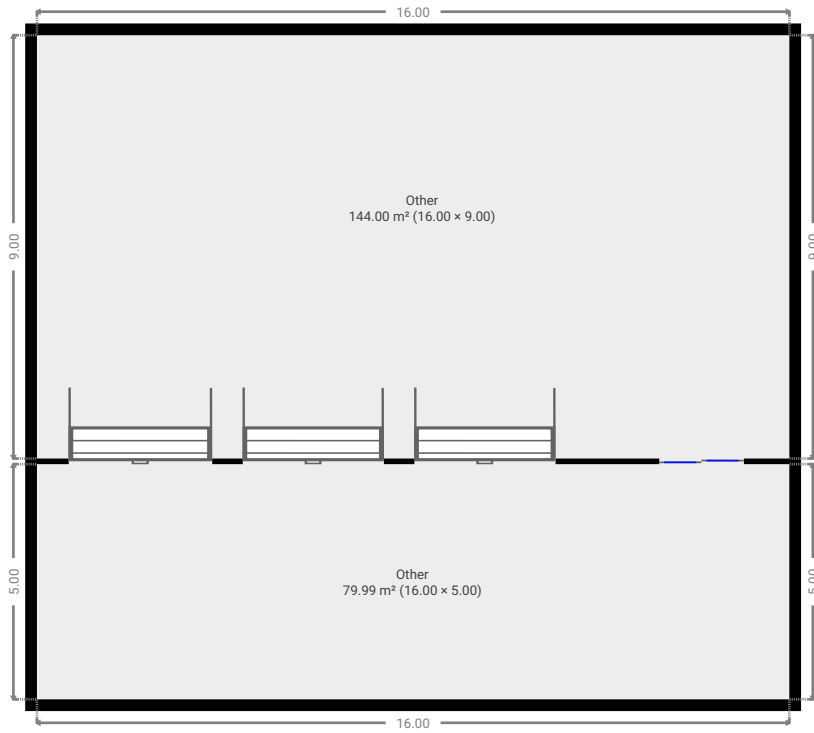

▼ Laundry Room
Ground Floor

WIDTH: 2.86 m • LENGTH: 2.20 m
AREA: 5.12 m² • PERIMETER: 10.12 m

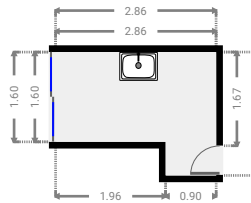
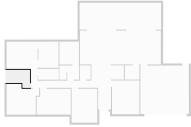

▼ Other
Ground Floor

WIDTH: 16.00 m • LENGTH: 5.00 m
AREA: 79.99 m² • PERIMETER: 42.00 m



▼ Other Ground Floor

WIDTH: 16.00 m • LENGTH: 9.00 m
AREA: 144.00 m² • PERIMETER: 50.00 m

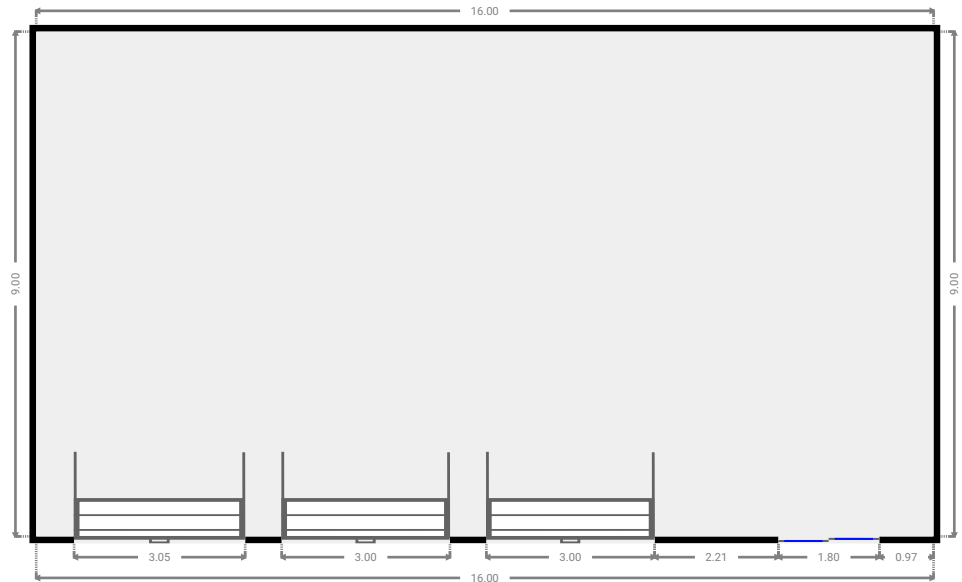
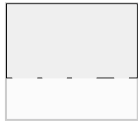

▼ Other Ground Floor

WIDTH: 10.05 m • LENGTH: 3.31 m
AREA: 33.26 m² • PERIMETER: 26.72 m

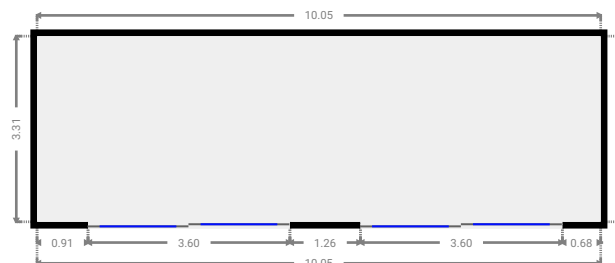
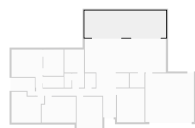

▼ **Garage**
Ground Floor

WIDTH: 5.98 m • LENGTH: 5.98 m
AREA: 35.73 m² • PERIMETER: 23.91 m

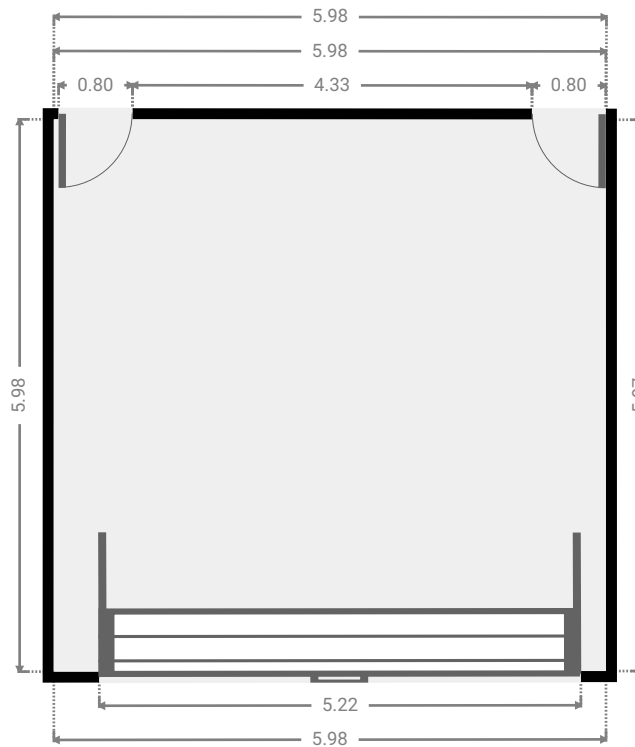
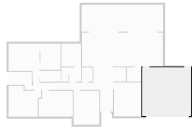

▼ **Closet**
Ground Floor

WIDTH: 1.80 m • LENGTH: 1.76 m
AREA: 3.17 m² • PERIMETER: 7.12 m

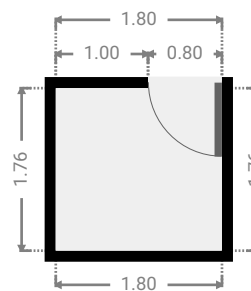
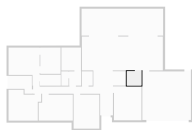

▼ Kitchen
Ground Floor

WIDTH: 9.98 m • LENGTH: 4.17 m
AREA: 41.59 m² • PERIMETER: 28.29 m

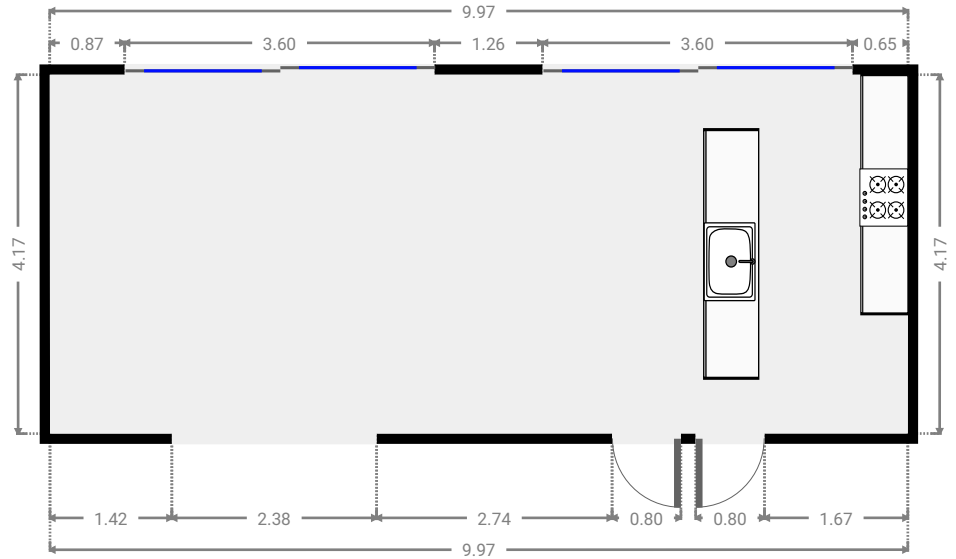
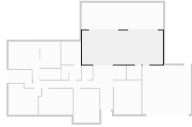

▼ Bathroom
Ground Floor

WIDTH: 2.49 m • LENGTH: 3.23 m
AREA: 8.04 m² • PERIMETER: 11.44 m

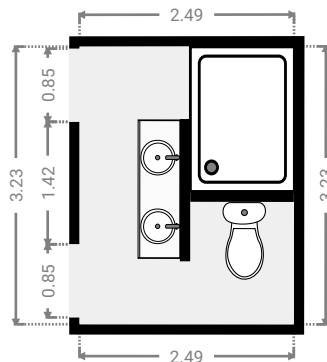

▼ **Master Bedroom**
Ground Floor

WIDTH: 3.82 m • LENGTH: 4.69 m
AREA: 13.99 m² • PERIMETER: 17.02 m

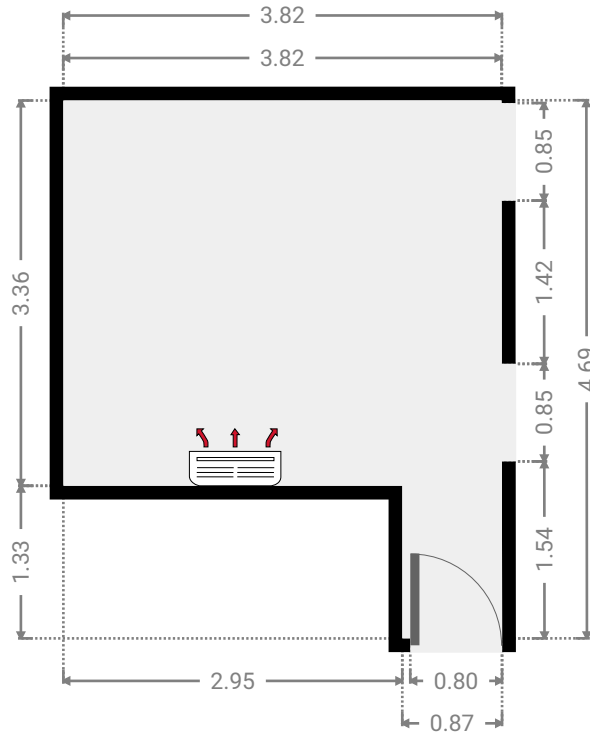

▼ **Closet**
Ground Floor

WIDTH: 2.57 m • LENGTH: 1.34 m
AREA: 3.44 m² • PERIMETER: 7.82 m

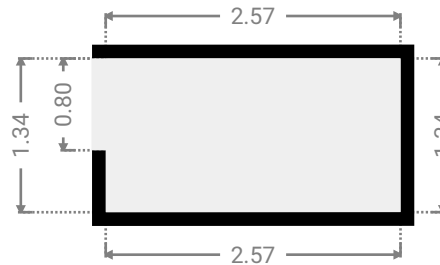

▼ **Hall**
Ground Floor

WIDTH: 11.43 m • LENGTH: 5.44 m
AREA: 20.19 m² • PERIMETER: 33.71 m

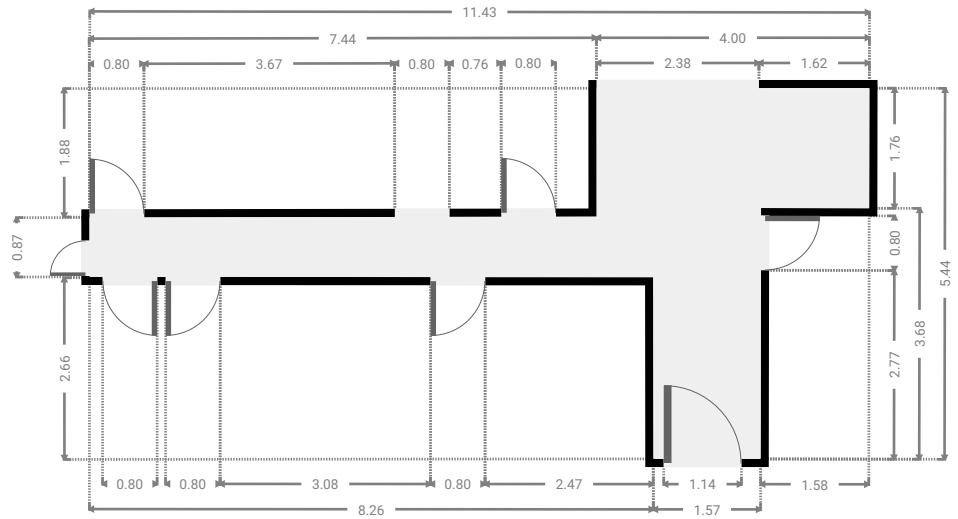

▼ **Bedroom**
Ground Floor

WIDTH: 4.02 m • LENGTH: 3.80 m
AREA: 12.99 m² • PERIMETER: 15.64 m

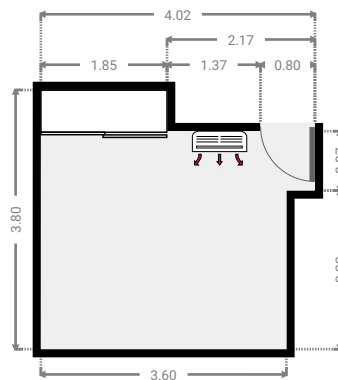

▼ **Bedroom**
Ground Floor

WIDTH: 4.20 m • LENGTH: 3.18 m
AREA: 12.94 m² • PERIMETER: 14.76 m

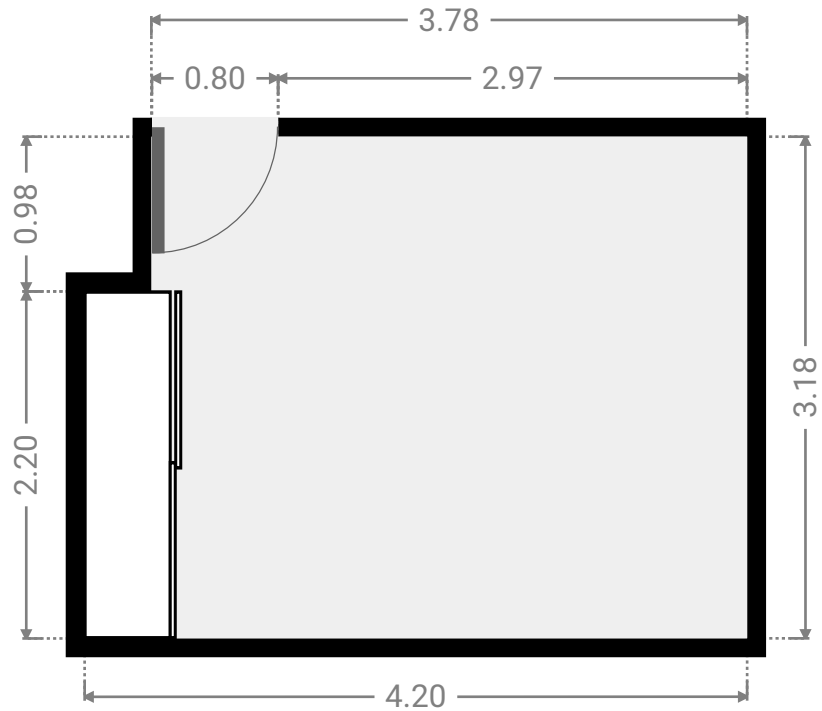

▼ **Bathroom**
Ground Floor

WIDTH: 2.40 m • LENGTH: 2.82 m
AREA: 6.77 m² • PERIMETER: 10.44 m

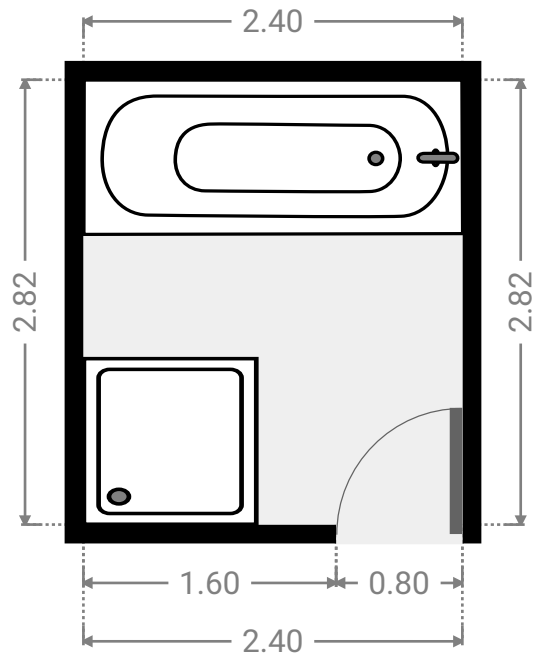

▼ Toilet
Ground Floor

WIDTH: 0.88 m • LENGTH: 1.75 m
AREA: 1.54 m² • PERIMETER: 5.26 m

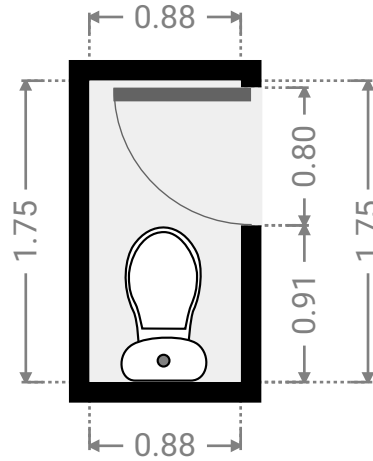

▼ Hall
Ground Floor

WIDTH: 1.46 m • LENGTH: 1.75 m
AREA: 2.55 m² • PERIMETER: 6.42 m

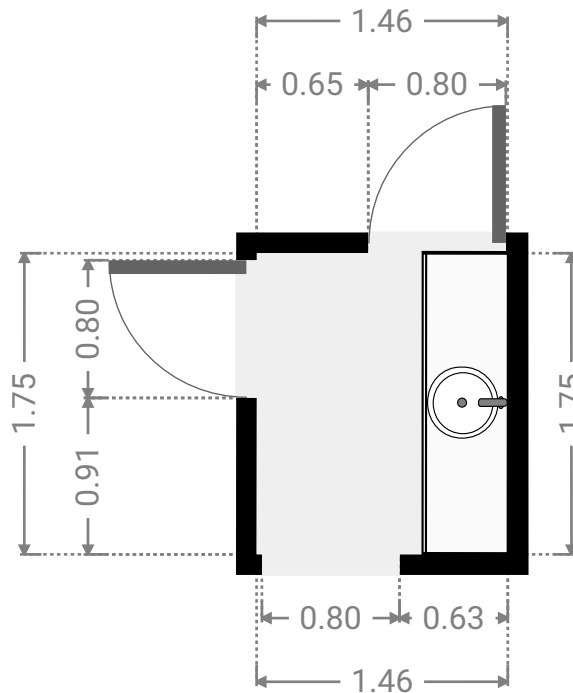
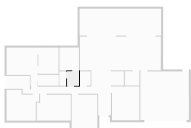

▼ **Bedroom**
Ground Floor

WIDTH: 3.17 m • LENGTH: 4.18 m
AREA: 13.24 m² • PERIMETER: 14.70 m

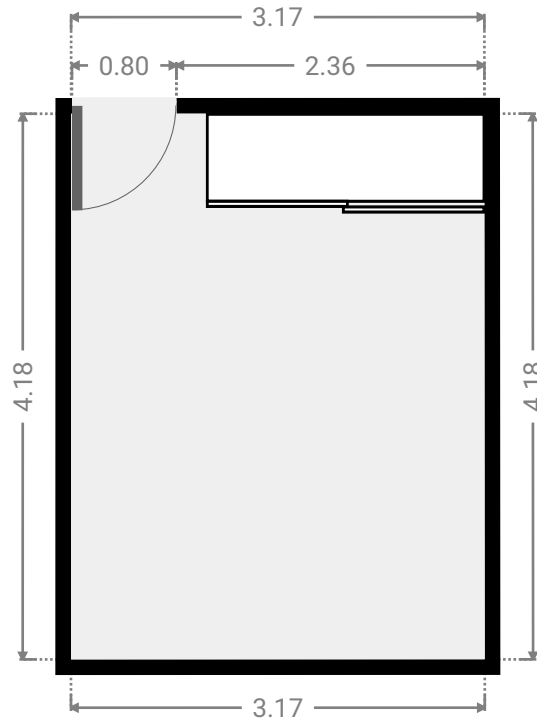

▼ **Closet**
Ground Floor

WIDTH: 1.34 m • LENGTH: 1.75 m
AREA: 2.34 m² • PERIMETER: 6.18 m

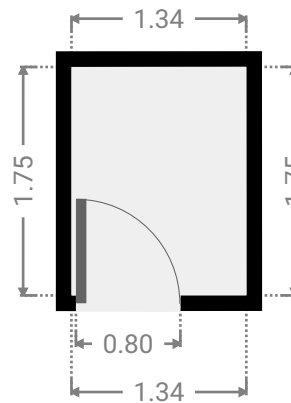
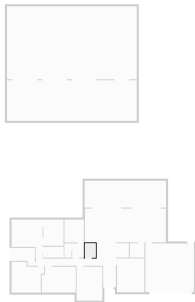

▼ Living Room
Ground Floor

WIDTH: 3.38 m • LENGTH: 4.17 m
AREA: 14.09 m² • PERIMETER: 15.10 m

