

5 Thomas Street

Ground Floor

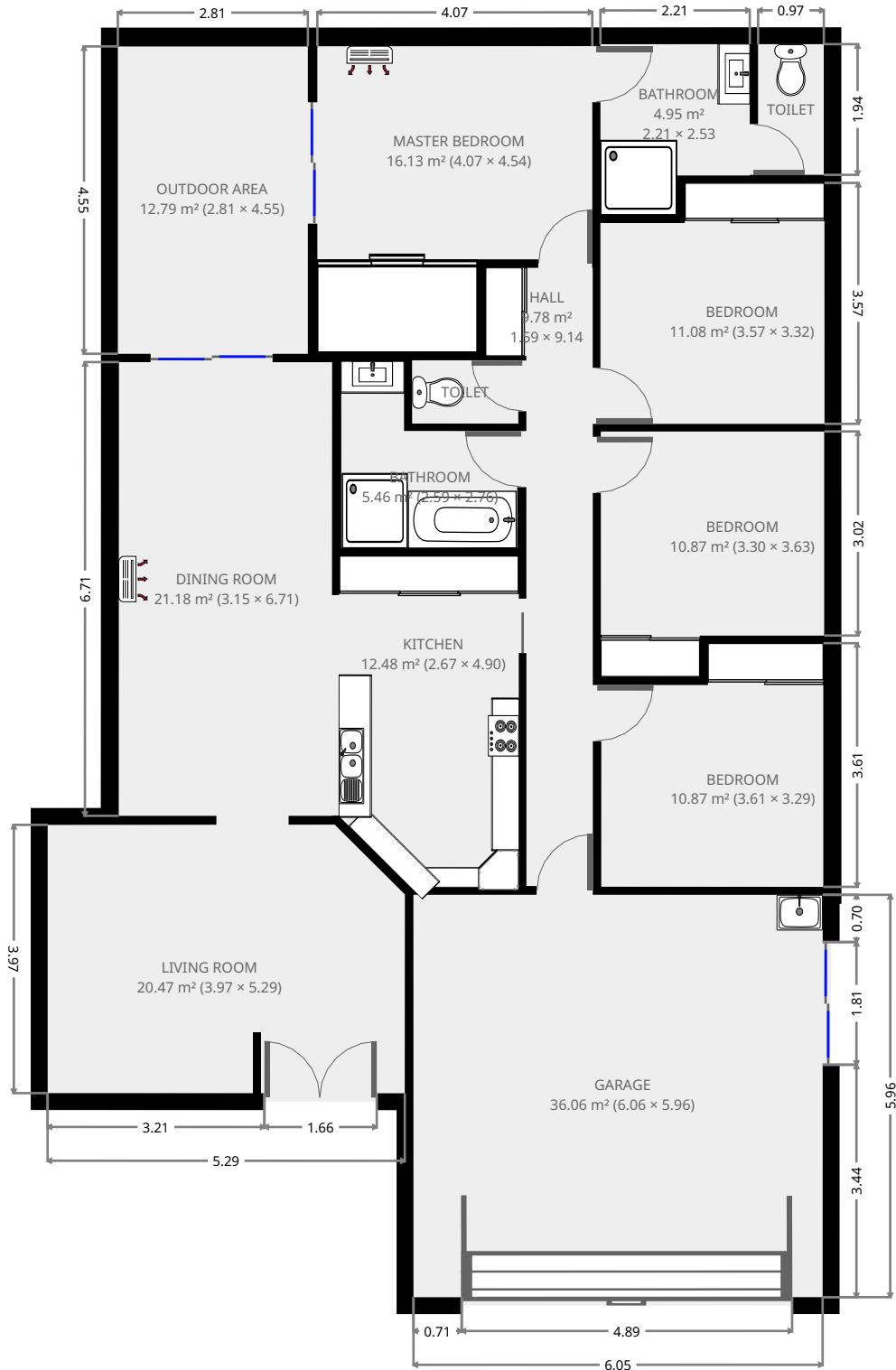

THIS FLOORPLAN IS PROVIDED WITHOUT WARRANTY OF ANY KIND. SENSOPIA DISCLAIMS ANY WARRANTY INCLUDING, WITHOUT LIMITATION, SATISFACTORY QUALITY OR ACCURACY OF DIMENSIONS.



5 Thomas Street

Living Room

Width: 3.97 m
 Length: 5.29 m
 Area: 20.47 m²
 Perimeter: 17.91 m
 Ceiling Height: 2.17 m

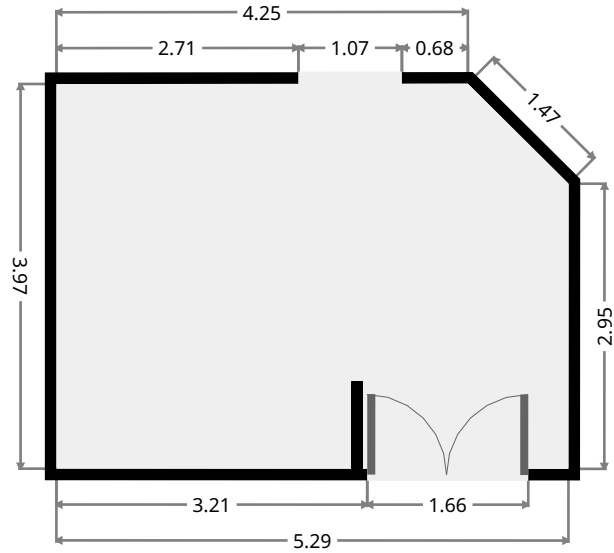
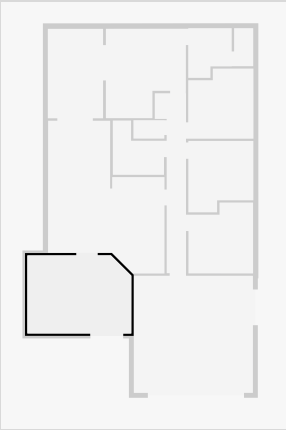

Dining Room

Width: 3.15 m
 Length: 6.71 m
 Area: 21.18 m²
 Perimeter: 19.74 m

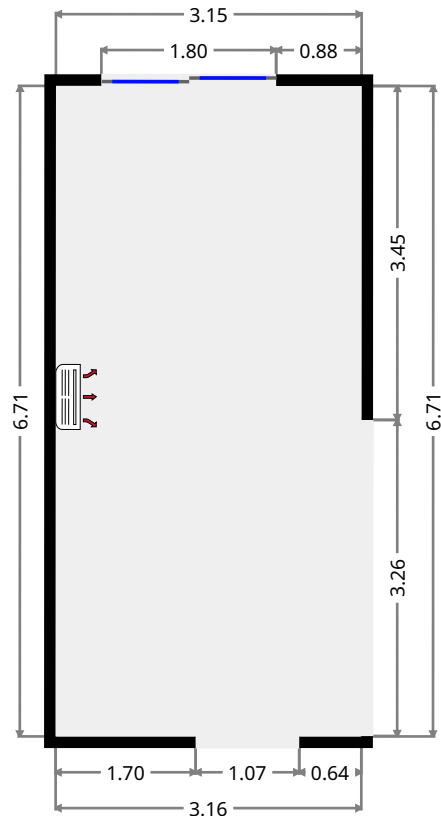
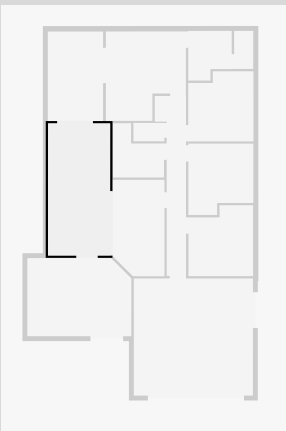

THIS FLOORPLAN IS PROVIDED WITHOUT WARRANTY OF ANY KIND. SENSOPIA DISCLAIMS ANY WARRANTY INCLUDING, WITHOUT LIMITATION, SATISFACTORY QUALITY OR ACCURACY OF DIMENSIONS.

5 Thomas Street

Kitchen

Width: 2.67 m
 Length: 4.90 m
 Area: 12.48 m²
 Perimeter: 14.51 m

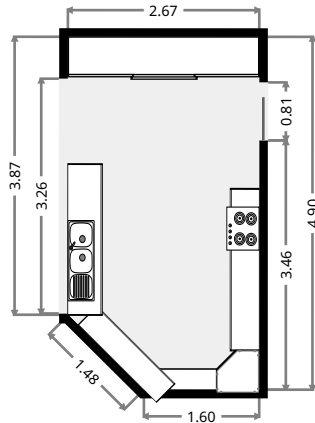
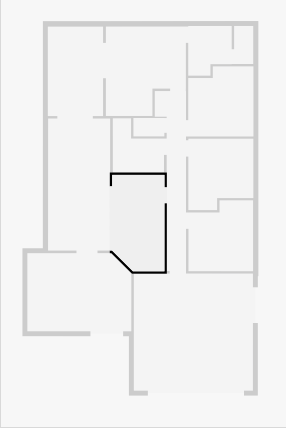

Hall

Width: 1.59 m
 Length: 9.14 m
 Area: 9.78 m²
 Perimeter: 21.47 m

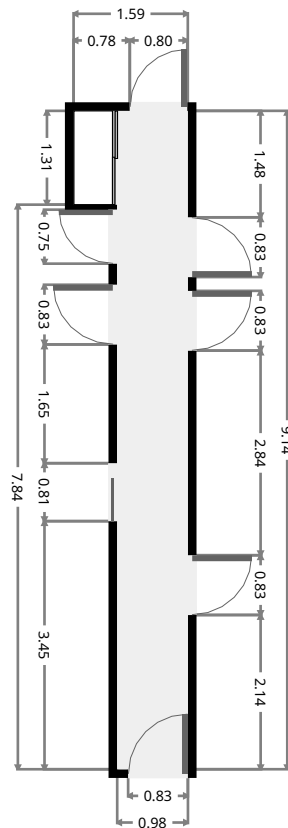
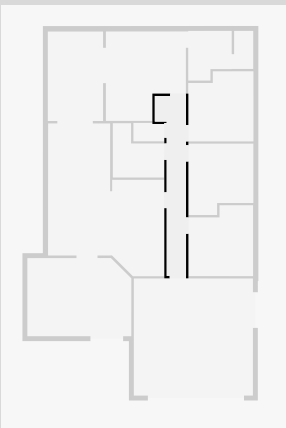

5 Thomas Street

Garage

Width: 5.96 m
 Length: 6.06 m
 Area: 36.06 m²
 Perimeter: 24.02 m

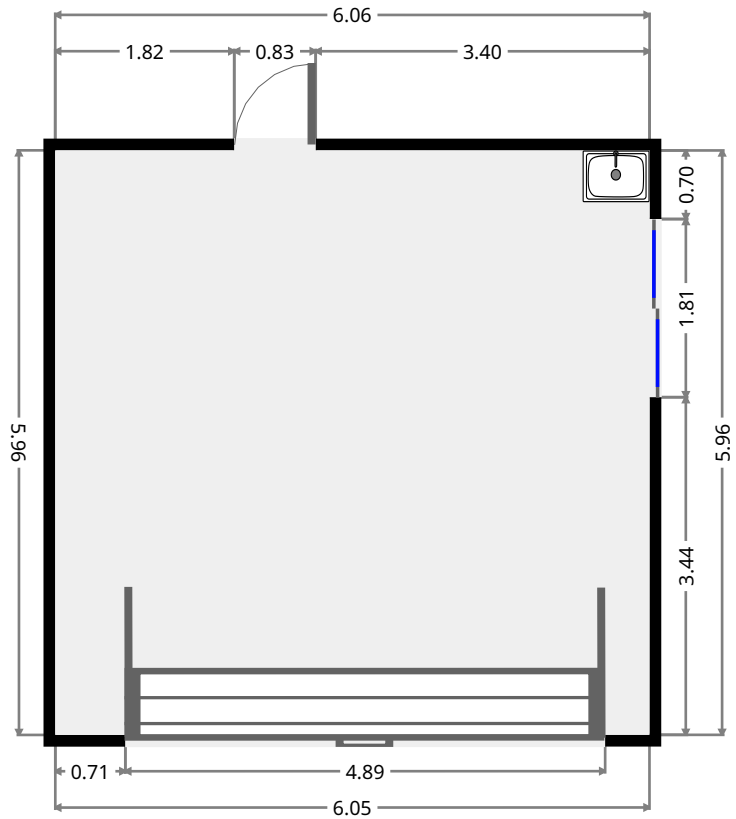
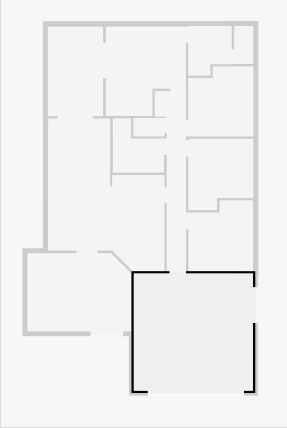

Bedroom

Width: 3.29 m
 Length: 3.61 m
 Area: 10.87 m²
 Perimeter: 13.78 m

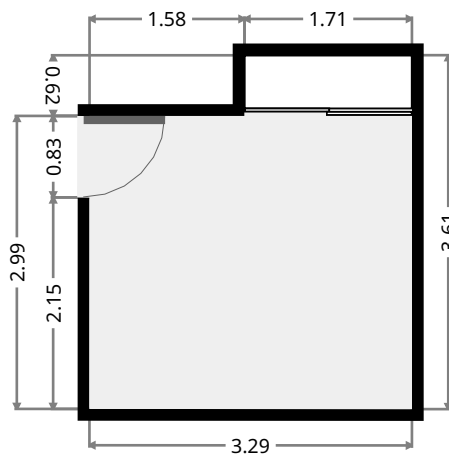
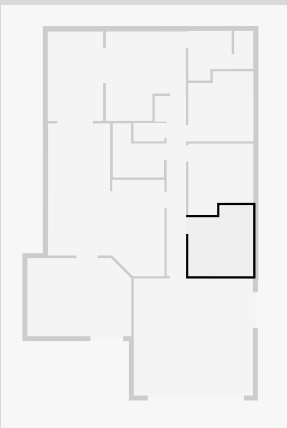

THIS FLOORPLAN IS PROVIDED WITHOUT WARRANTY OF ANY KIND. SENSOPIA DISCLAIMS ANY WARRANTY INCLUDING, WITHOUT LIMITATION, SATISFACTORY QUALITY OR ACCURACY OF DIMENSIONS.



5 Thomas Street

Bedroom

Width: 3.30 m
Length: 3.63 m
Area: 10.87 m²
Perimeter: 13.87 m

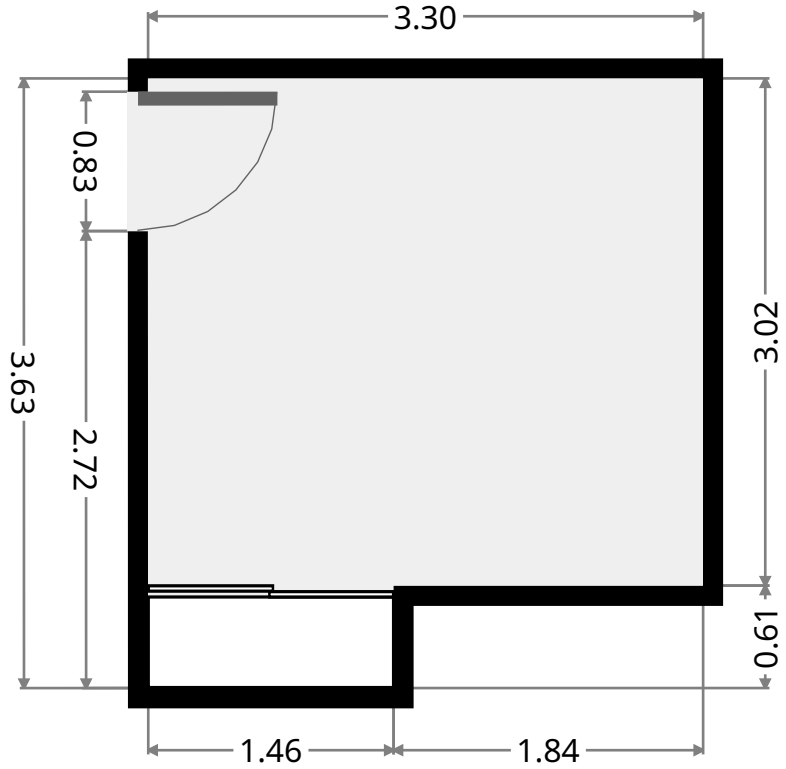
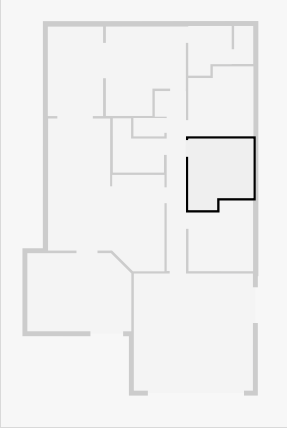

Bathroom

Width: 2.59 m
Length: 2.76 m
Area: 5.46 m²
Perimeter: 10.72 m

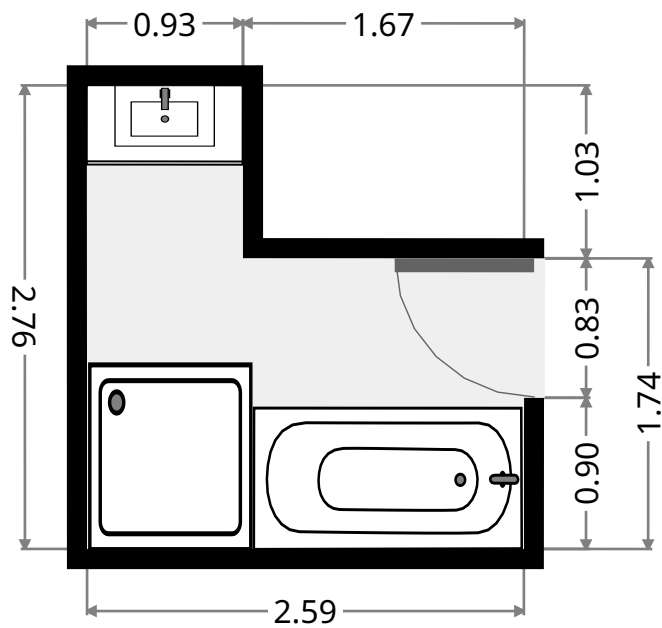
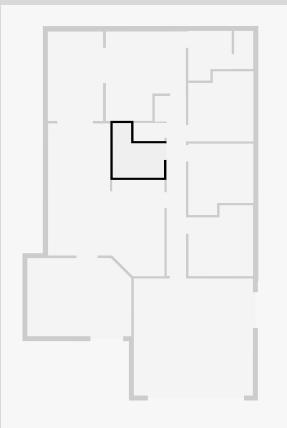

5 Thomas Street

Toilet

Width: 0.94 m
Length: 1.57 m
Area: 1.47 m²
Perimeter: 5.02 m

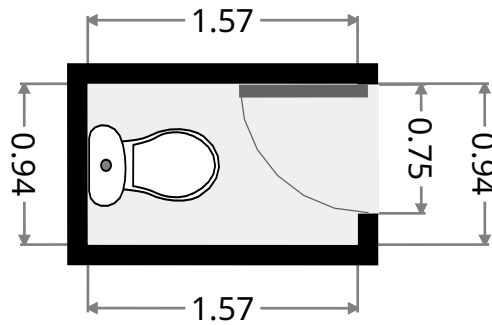
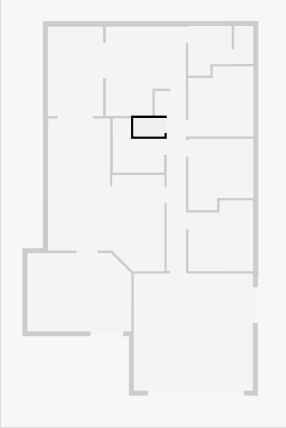

Bedroom

Width: 3.32 m
Length: 3.57 m
Area: 11.08 m²
Perimeter: 13.76 m

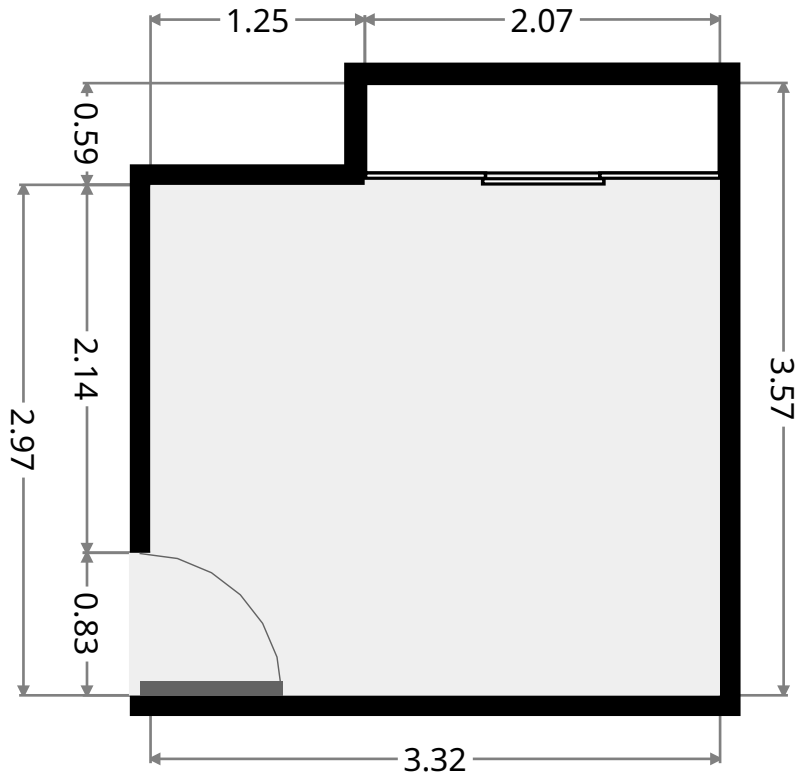
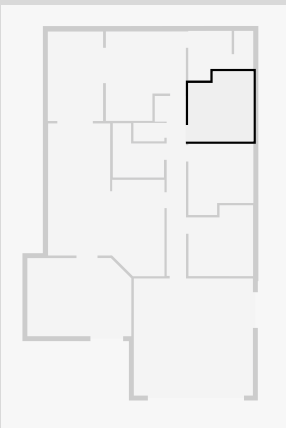

5 Thomas Street

Master Bedroom

Width: 4.07 m
 Length: 4.54 m
 Area: 16.13 m²
 Perimeter: 17.23 m

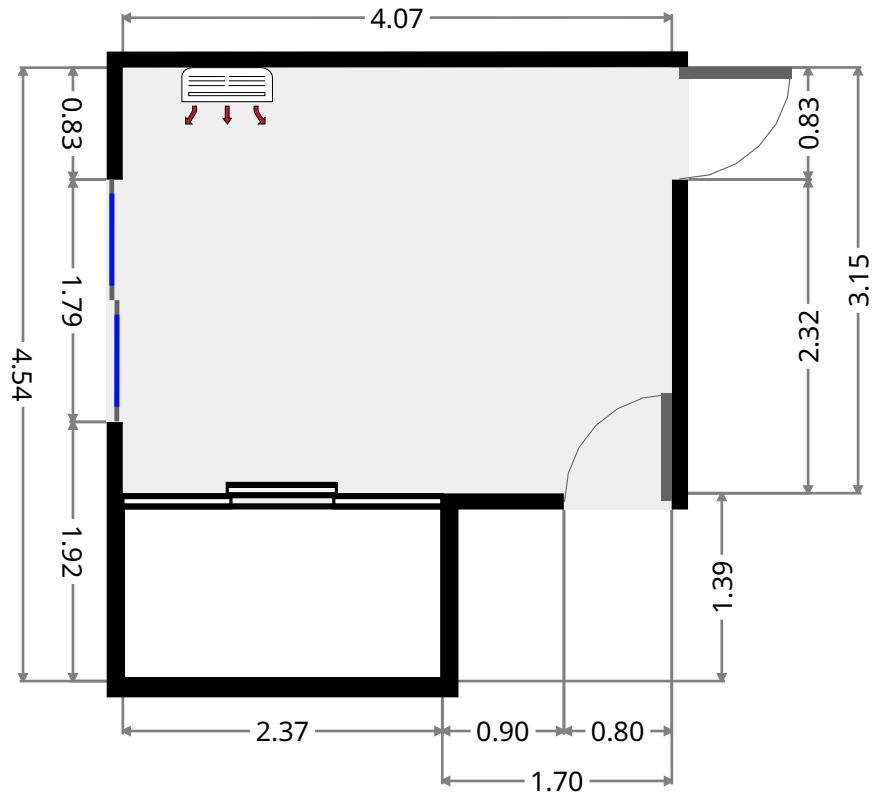
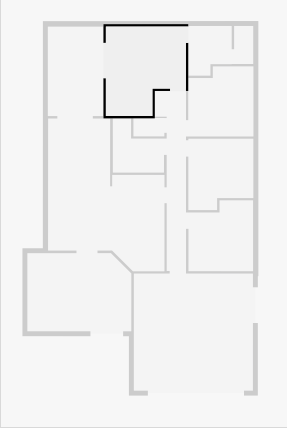

Bathroom

Width: 2.21 m
 Length: 2.53 m
 Area: 4.95 m²
 Perimeter: 9.47 m

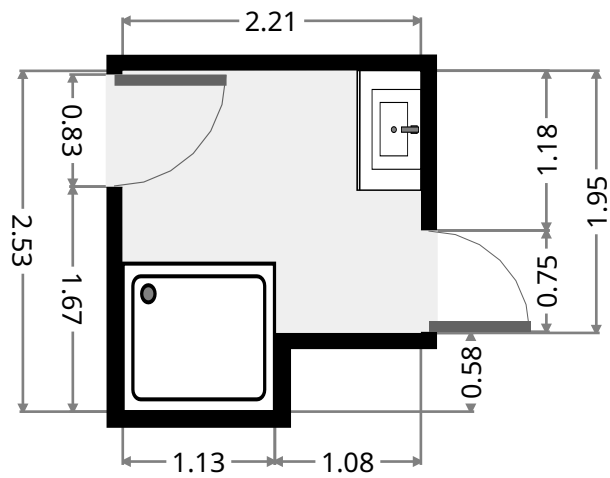
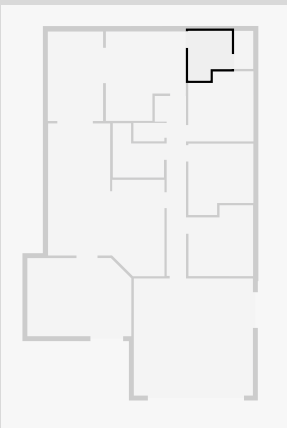

5 Thomas Street

Toilet

Width: 0.97 m
Length: 1.94 m
Area: 1.88 m²
Perimeter: 5.81 m

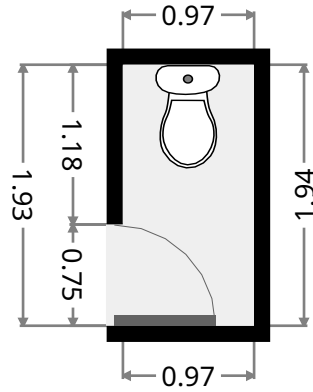
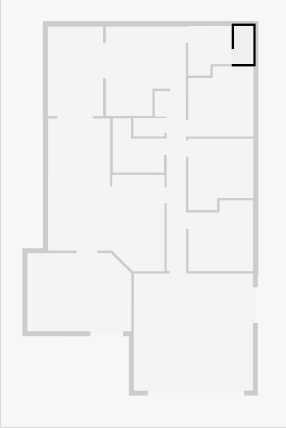

Outdoor Area

Width: 2.81 m
Length: 4.55 m
Area: 12.79 m²
Perimeter: 14.72 m

