

5 Riverwood Grove

Created on
2021-03-02

Floors
1

▼ Ground Floor

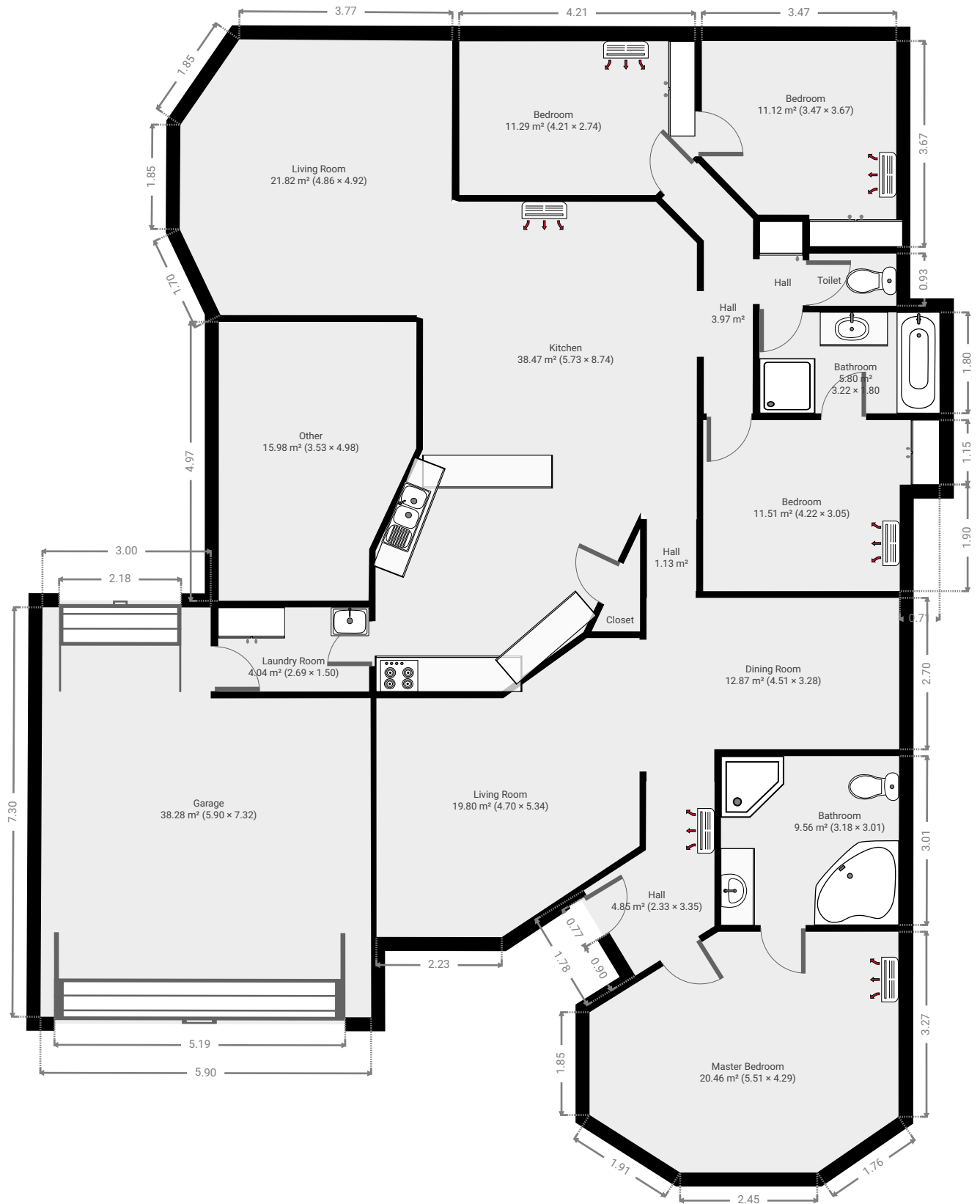

▼ **Hall**
Ground Floor

WIDTH: 1.63 m • LENGTH: 4.47 m
AREA: 3.97 m² • PERIMETER: 10.79 m

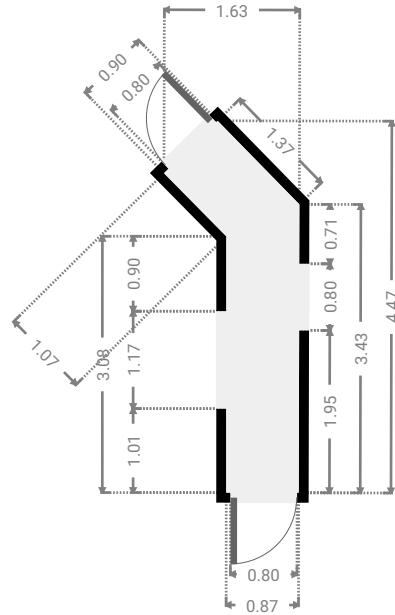
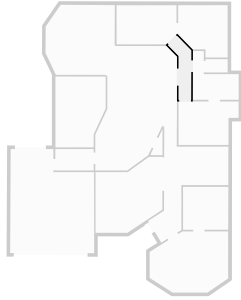

▼ **Garage**
Ground Floor

WIDTH: 5.90 m • LENGTH: 7.32 m
AREA: 38.28 m² • PERIMETER: 26.36 m

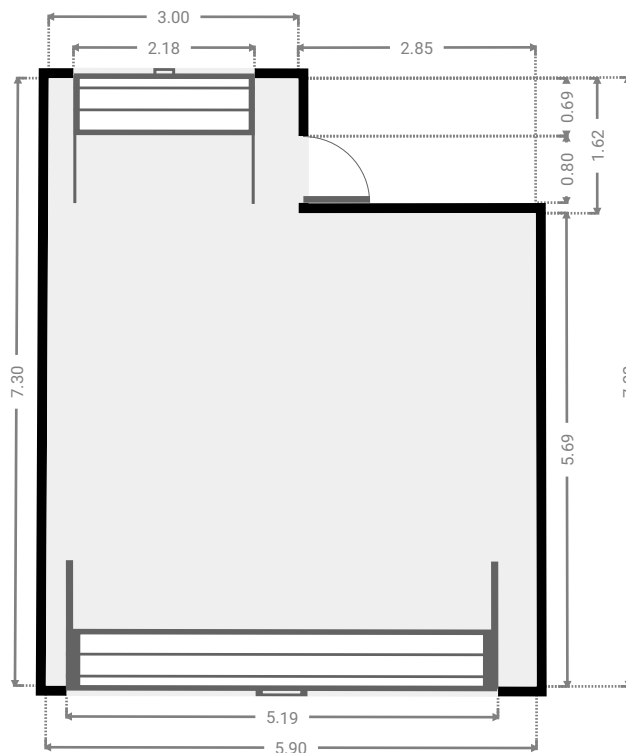
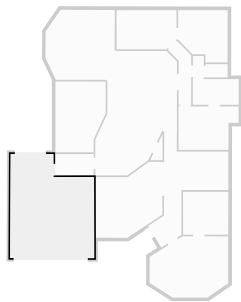

▼ Laundry Room
Ground Floor

WIDTH: 2.69 m • LENGTH: 1.50 m
AREA: 4.04 m² • PERIMETER: 8.38 m

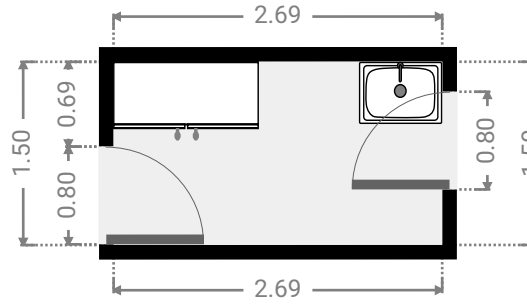
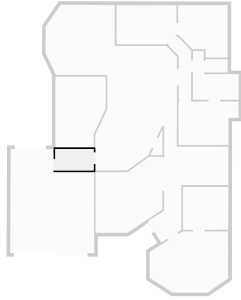

▼ Other
Ground Floor

WIDTH: 3.53 m • LENGTH: 4.98 m
AREA: 15.98 m² • PERIMETER: 16.33 m

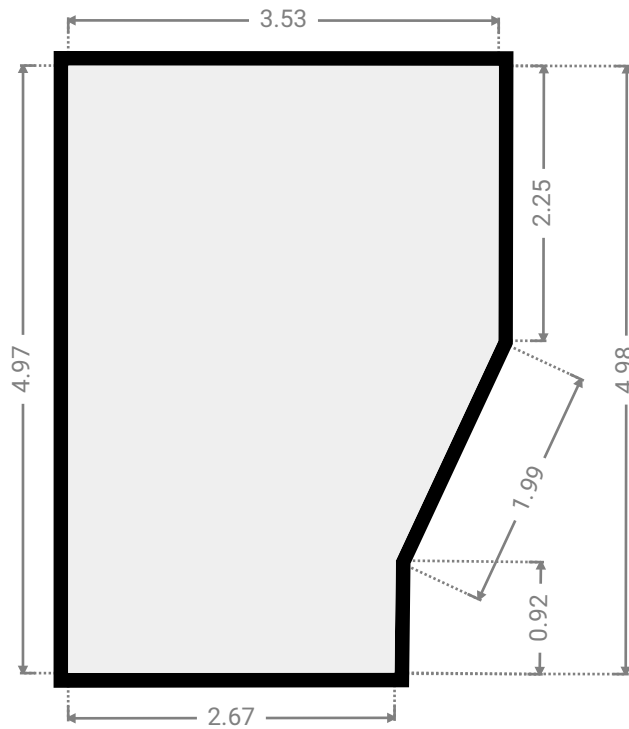
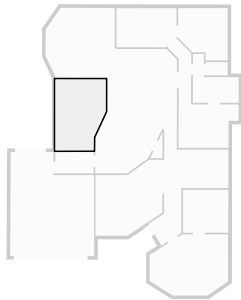

▼ Bedroom Ground Floor

WIDTH: 4.22 m • LENGTH: 3.05 m
AREA: 11.51 m² • PERIMETER: 14.54 m

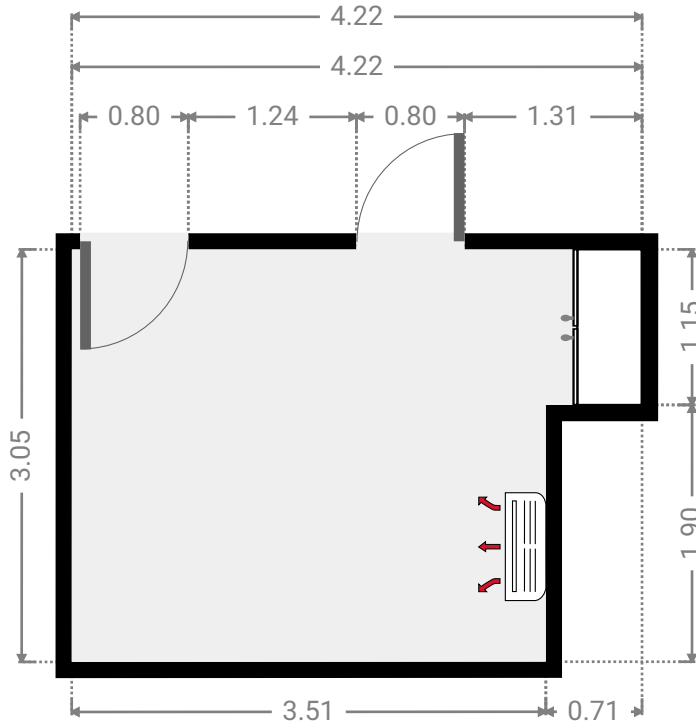
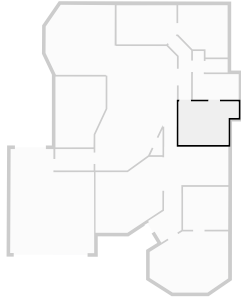

▼ Bathroom Ground Floor

WIDTH: 3.22 m • LENGTH: 1.80 m
AREA: 5.80 m² • PERIMETER: 10.04 m

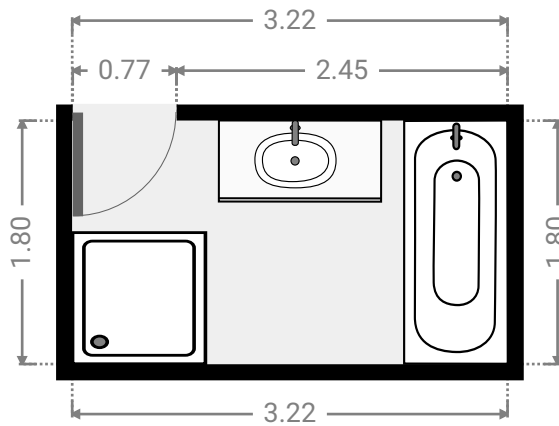
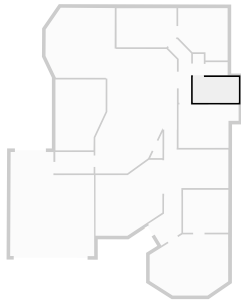

▼ Toilet
Ground Floor

WIDTH: 1.55 m • LENGTH: 0.93 m
AREA: 1.45 m² • PERIMETER: 4.97 m

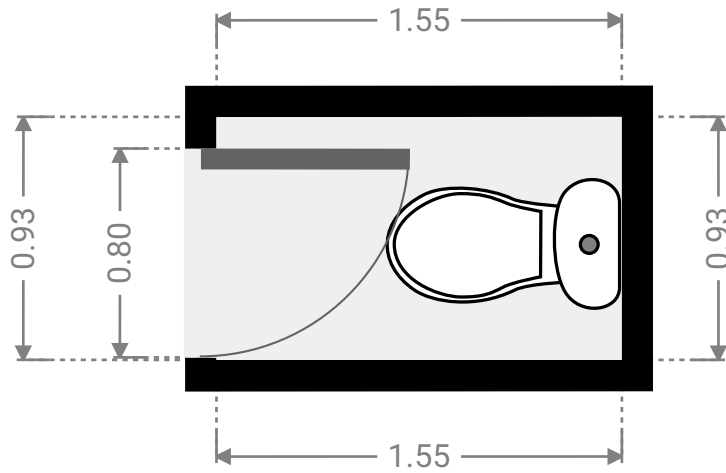
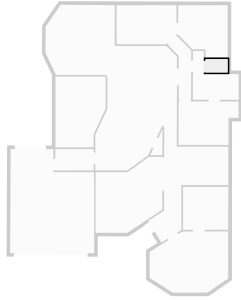

▼ Hall
Ground Floor

WIDTH: 0.77 m • LENGTH: 1.50 m
AREA: 1.15 m² • PERIMETER: 4.53 m

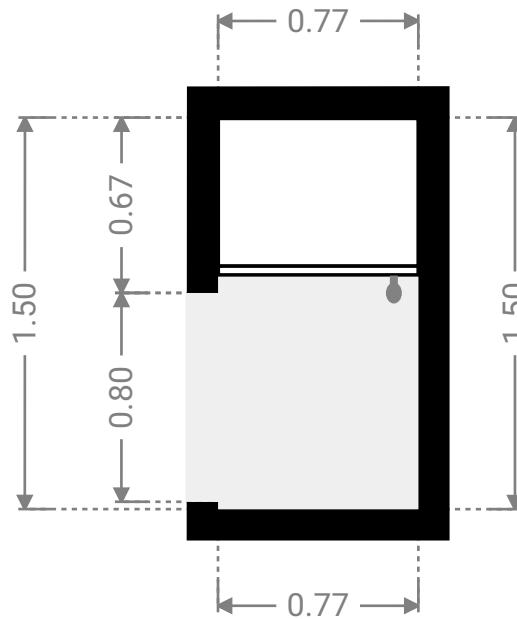
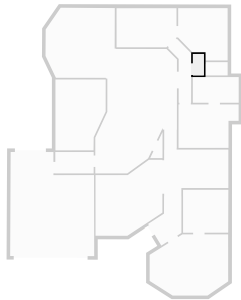

▼ **Bedroom**
Ground Floor

WIDTH: 3.47 m • LENGTH: 3.67 m
AREA: 11.12 m² • PERIMETER: 13.68 m

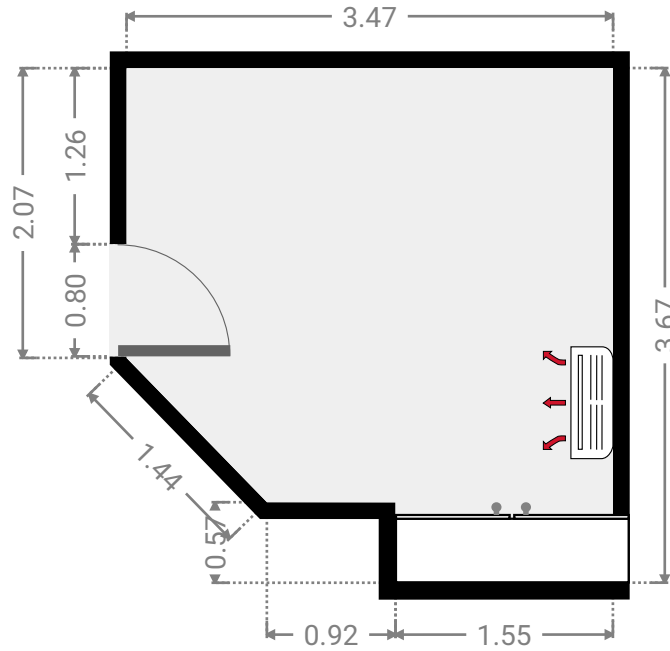
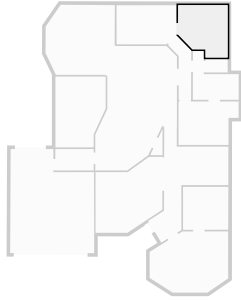

▼ **Bedroom**
Ground Floor

WIDTH: 4.21 m • LENGTH: 2.74 m
AREA: 11.29 m² • PERIMETER: 13.49 m

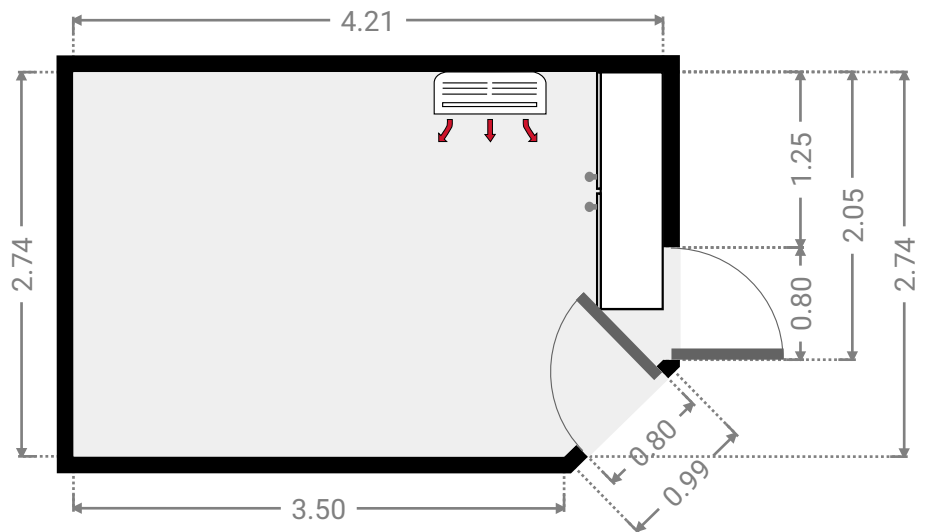
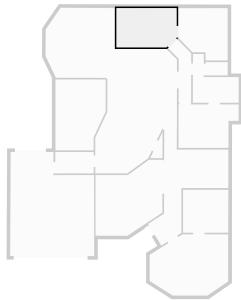

▼ Hall Ground Floor

WIDTH: 2.33 m • LENGTH: 3.35 m
AREA: 4.85 m² • PERIMETER: 9.55 m

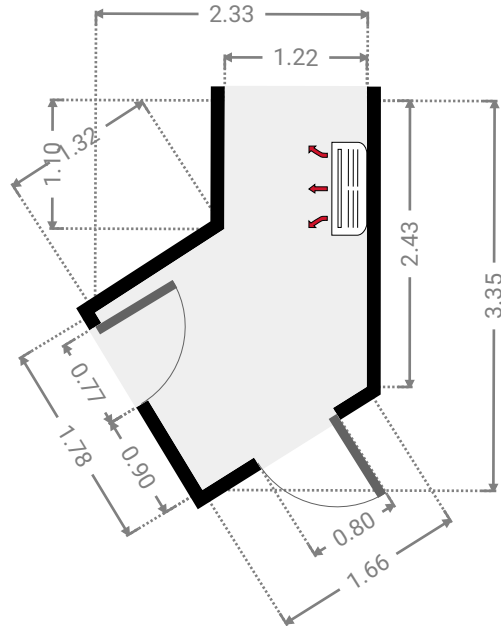
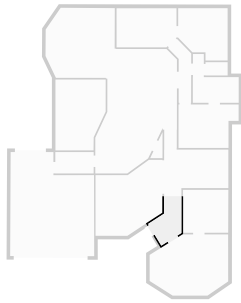

▼ Living Room Ground Floor

WIDTH: 4.86 m • LENGTH: 4.92 m
AREA: 21.82 m² • PERIMETER: 17.70 m

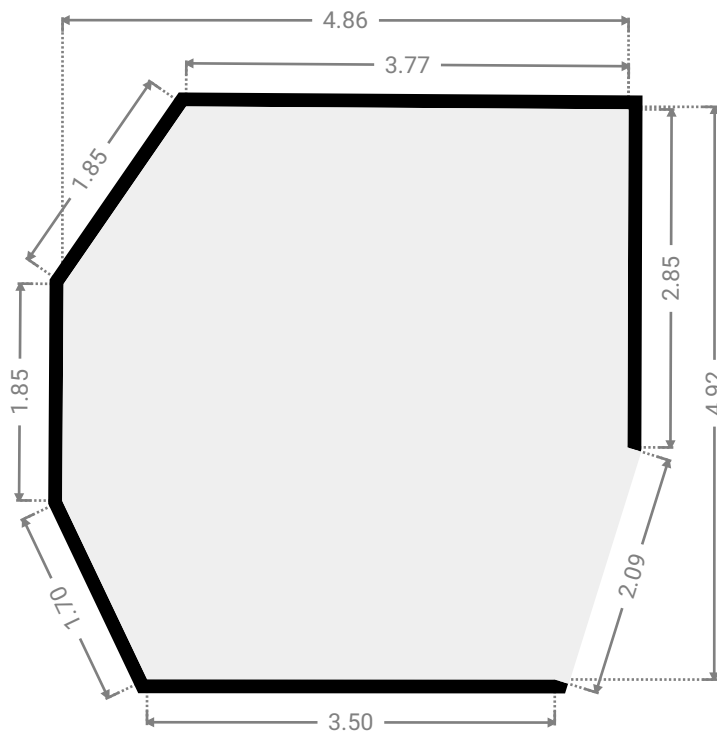
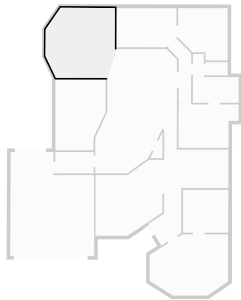

▼ **Closet**
Ground Floor

WIDTH: 0.86 m • LENGTH: 1.83 m
AREA: 0.79 m² • PERIMETER: 4.72 m

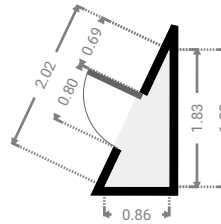
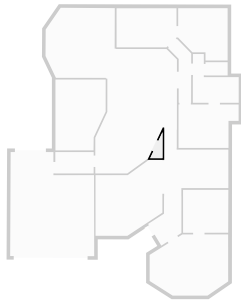

▼ **Kitchen**
Ground Floor

WIDTH: 5.73 m • LENGTH: 8.74 m
AREA: 38.47 m² • PERIMETER: 25.80 m

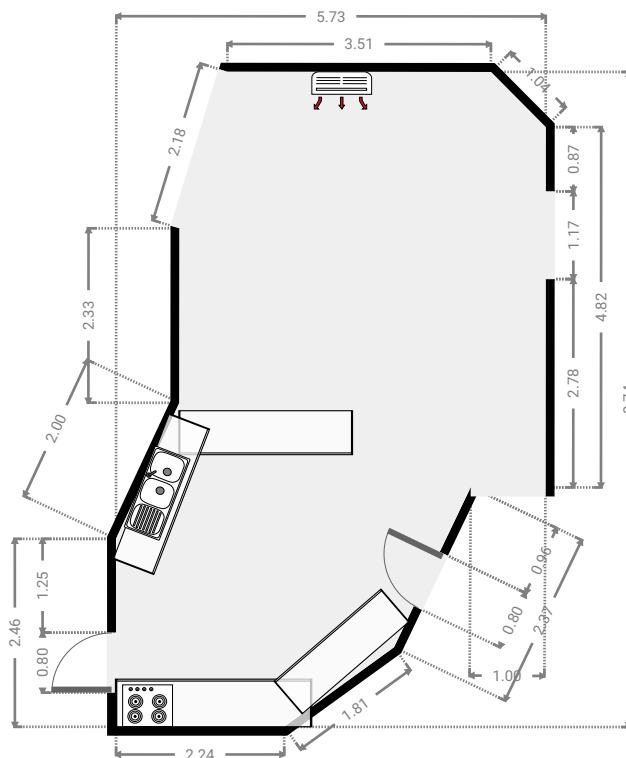
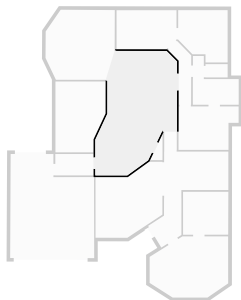

▼ **Hall**
Ground Floor

WIDTH: 0.88 m • LENGTH: 1.28 m
AREA: 1.13 m² • PERIMETER: 4.32 m

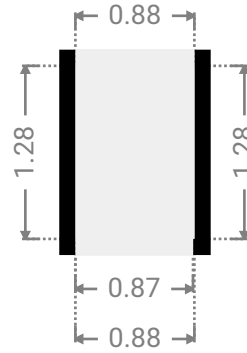
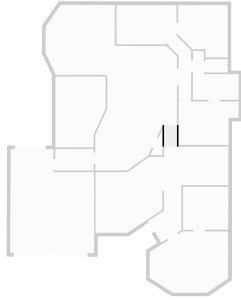

▼ **Bathroom**
Ground Floor

WIDTH: 3.18 m • LENGTH: 3.01 m
AREA: 9.56 m² • PERIMETER: 12.37 m

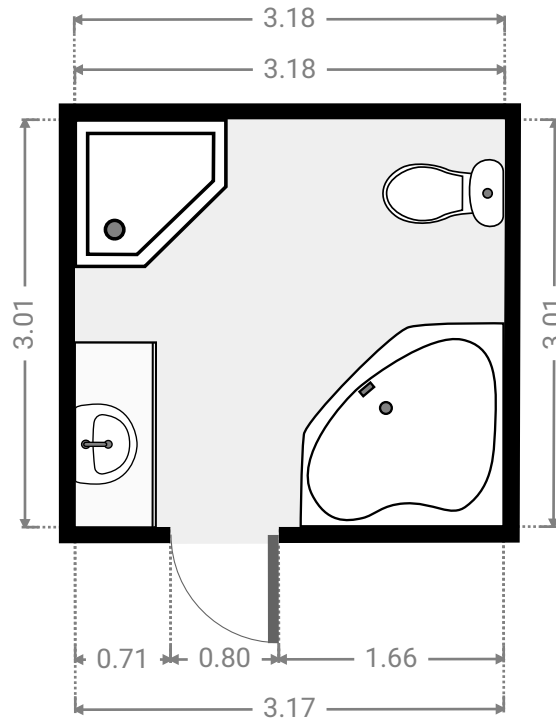
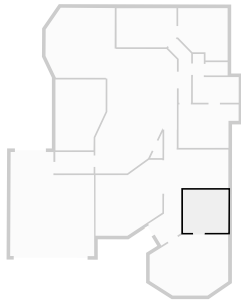

▼ **Master Bedroom**
Ground Floor

WIDTH: 5.51 m • LENGTH: 4.29 m
AREA: 20.46 m² • PERIMETER: 17.17 m

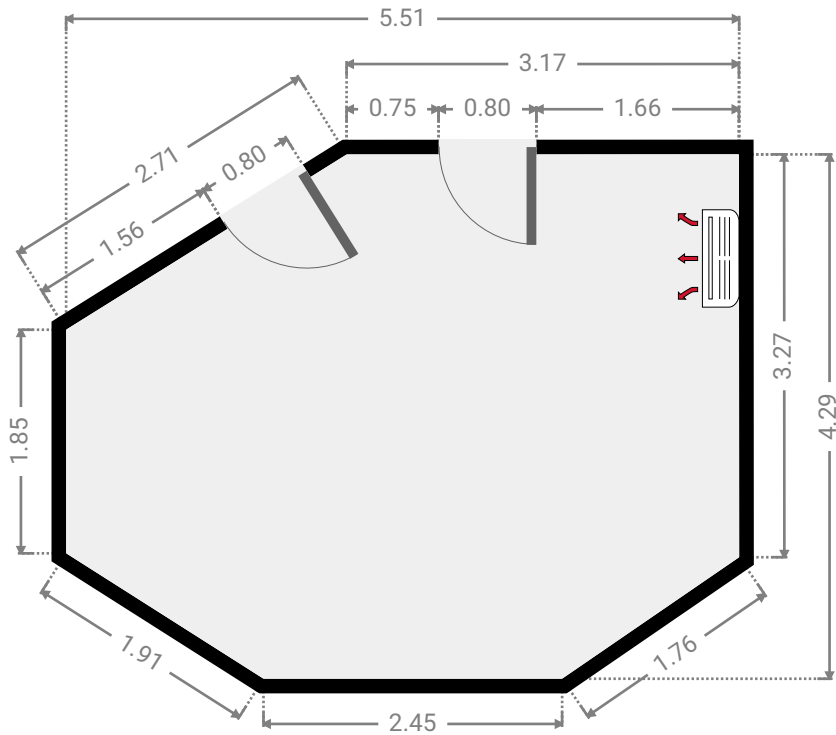
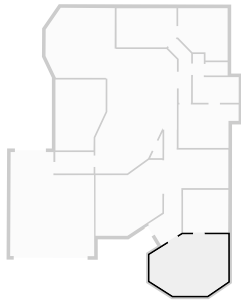

▼ **Dining Room**
Ground Floor

WIDTH: 4.51 m • LENGTH: 3.28 m
AREA: 12.87 m² • PERIMETER: 15.57 m

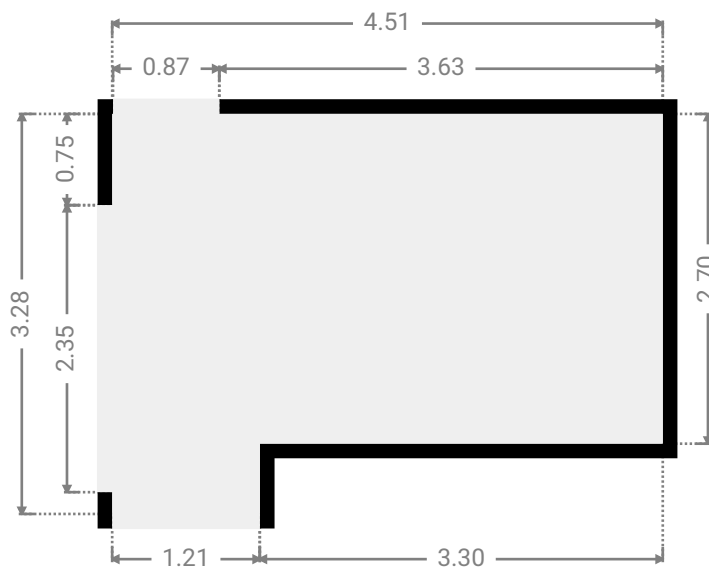
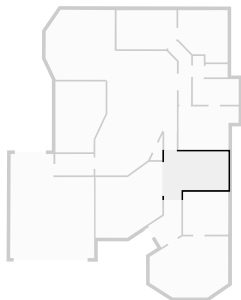

▼ Living Room Ground Floor

WIDTH: 4.70 m • LENGTH: 5.34 m
AREA: 19.80 m² • PERIMETER: 18.18 m

