

# 5 Pearson Street

Created on  
2021-03-25

Floors  
2

▼ Ground Floor

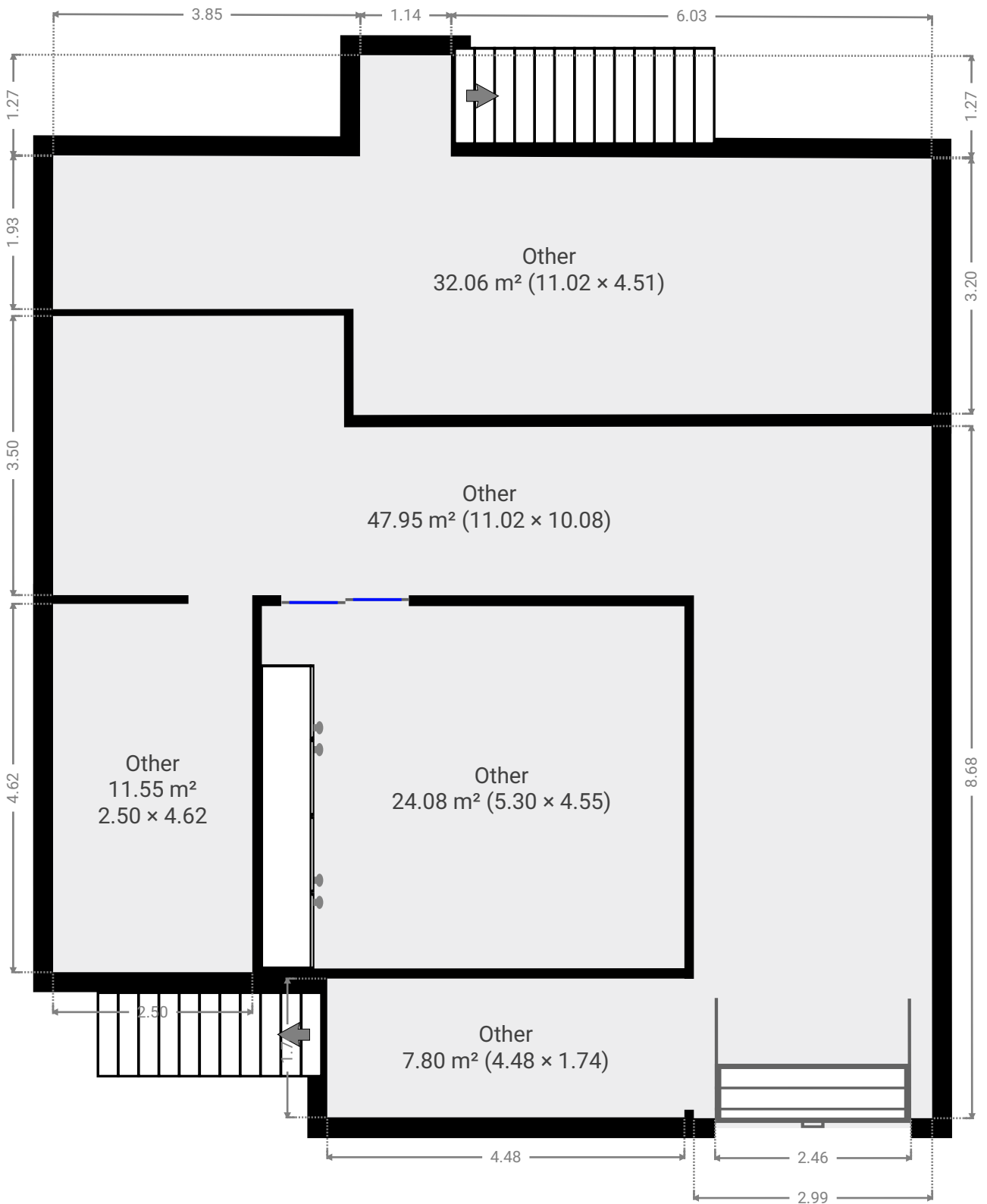

▼ Other  
Ground Floor

WIDTH: 2.50 m • LENGTH: 4.62 m  
AREA: 11.55 m<sup>2</sup> • PERIMETER: 14.24 m

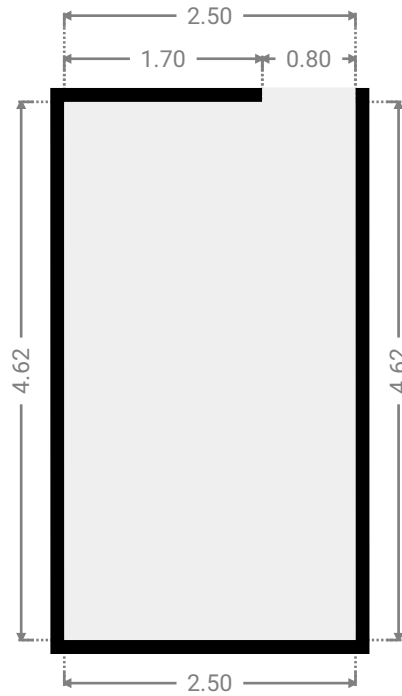
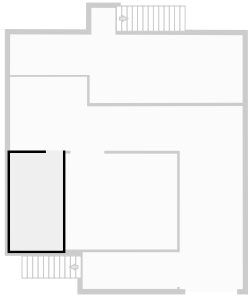

▼ Other  
Ground Floor

WIDTH: 5.30 m • LENGTH: 4.55 m  
AREA: 24.08 m<sup>2</sup> • PERIMETER: 19.69 m

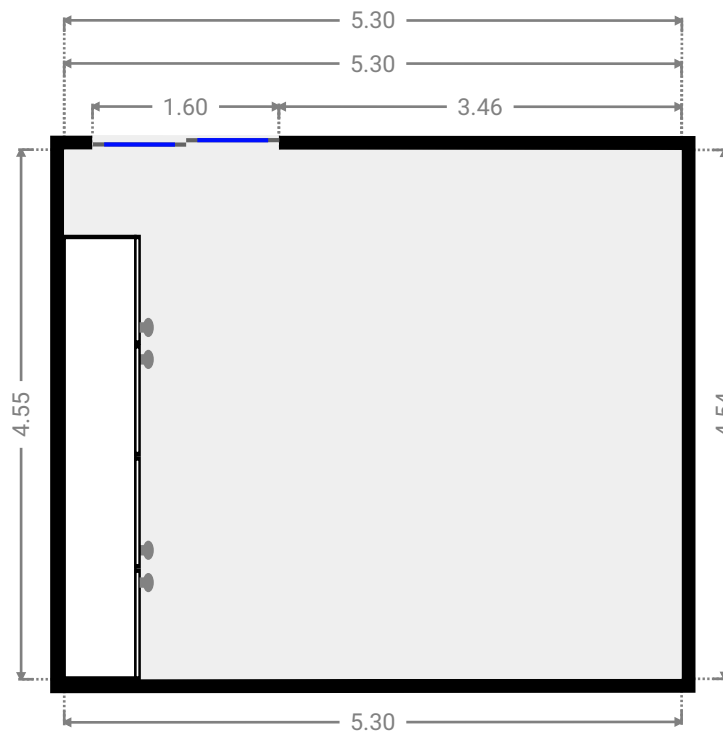
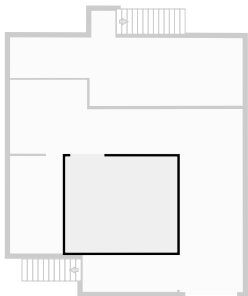

▼ Other  
Ground Floor

WIDTH: 11.02 m • LENGTH: 10.08 m  
AREA: 47.95 m<sup>2</sup> • PERIMETER: 42.19 m

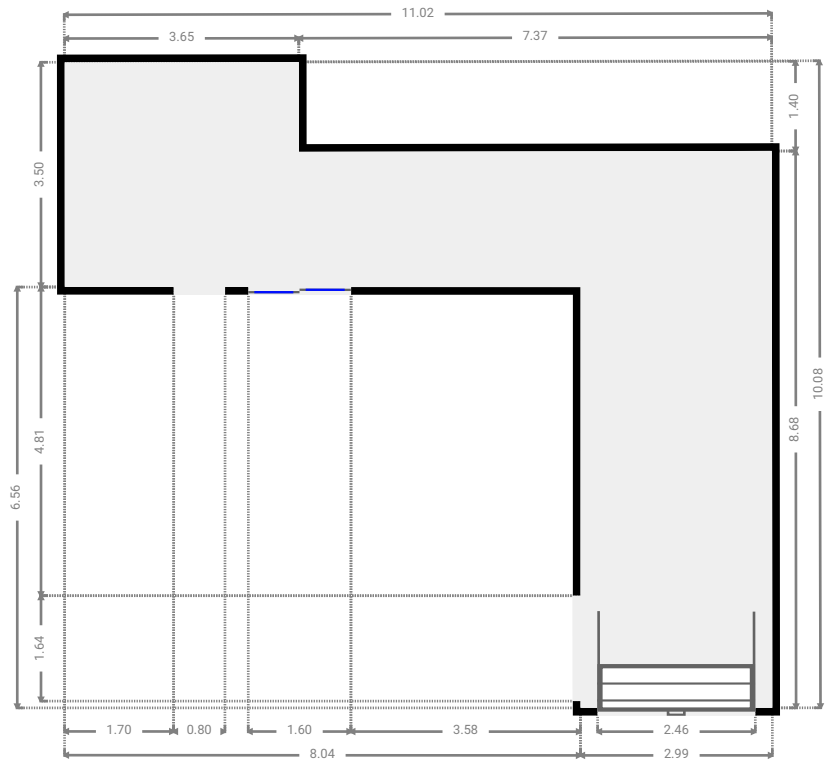
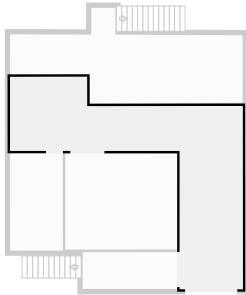

▼ Other  
Ground Floor

WIDTH: 4.48 m • LENGTH: 1.74 m  
AREA: 7.80 m<sup>2</sup> • PERIMETER: 12.44 m

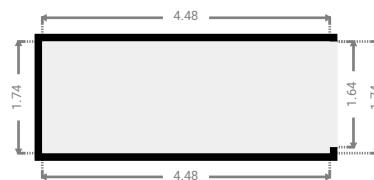
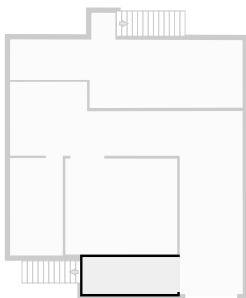

▼ Other  
Ground Floor

WIDTH: 11.02 m • LENGTH: 4.51 m  
AREA: 32.06 m<sup>2</sup> • PERIMETER: 31.04 m

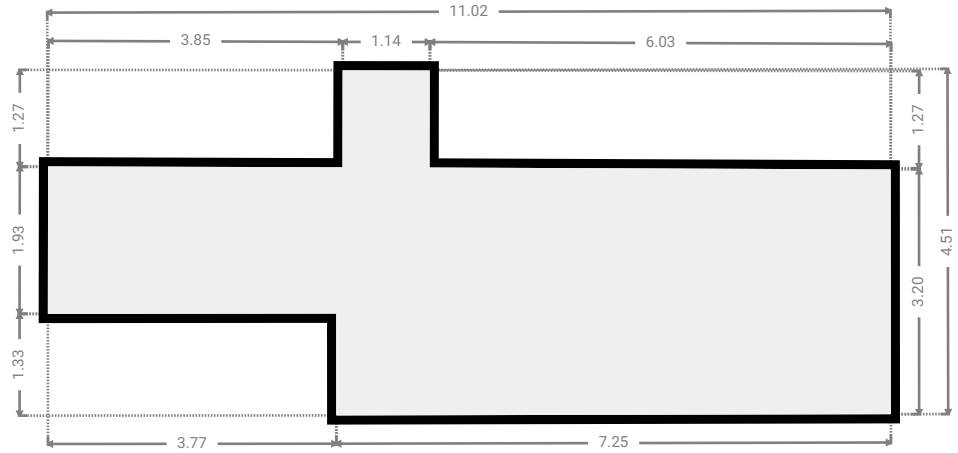
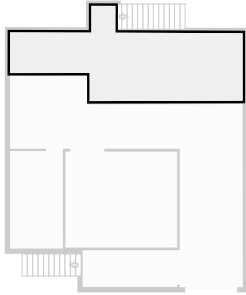

## ▼ 1st Floor



▼ Living Room  
1st Floor

WIDTH: 4.27 m • LENGTH: 4.33 m  
AREA: 18.49 m<sup>2</sup> • PERIMETER: 17.20 m

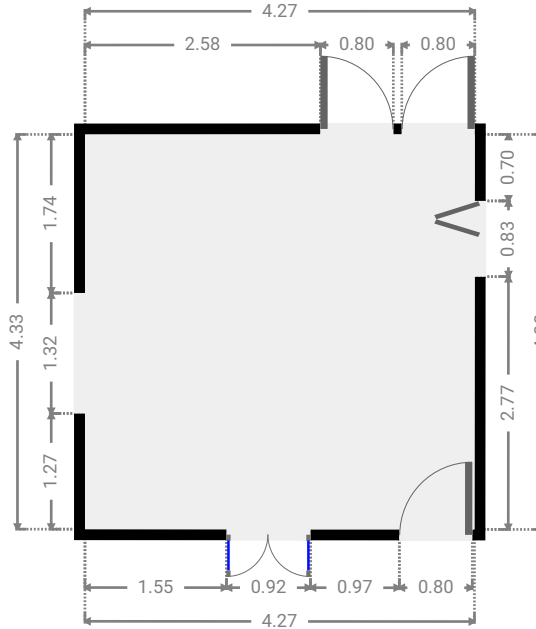
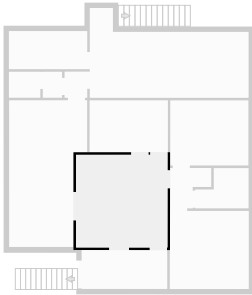

▼ Kitchen  
1st Floor

WIDTH: 3.65 m • LENGTH: 6.85 m  
AREA: 22.13 m<sup>2</sup> • PERIMETER: 20.99 m

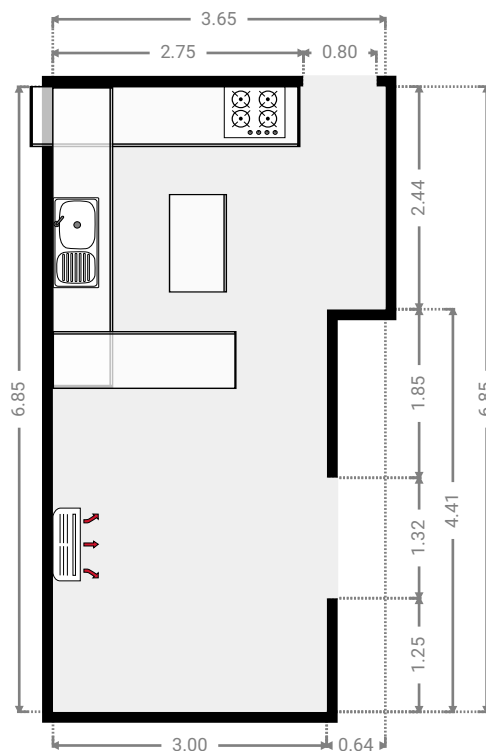
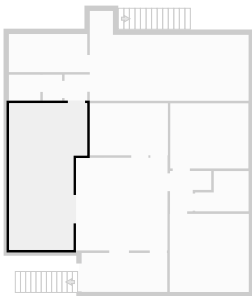

▼ **Hall**  
1st Floor

WIDTH: 1.06 m • LENGTH: 1.22 m  
AREA: 1.29 m<sup>2</sup> • PERIMETER: 4.56 m

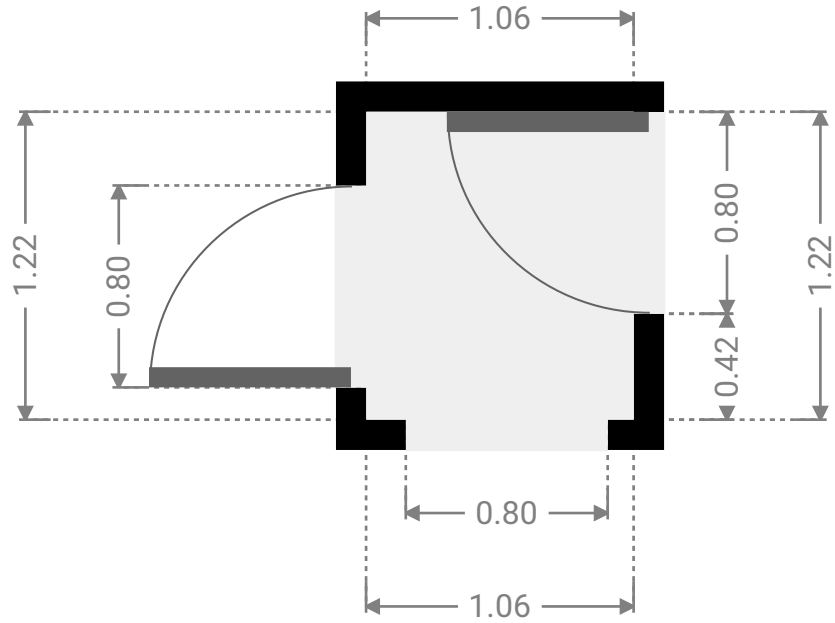
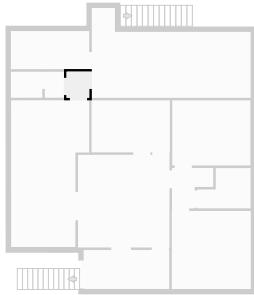

▼ **Hall**  
1st Floor

WIDTH: 0.90 m • LENGTH: 1.21 m  
AREA: 1.09 m<sup>2</sup> • PERIMETER: 4.23 m

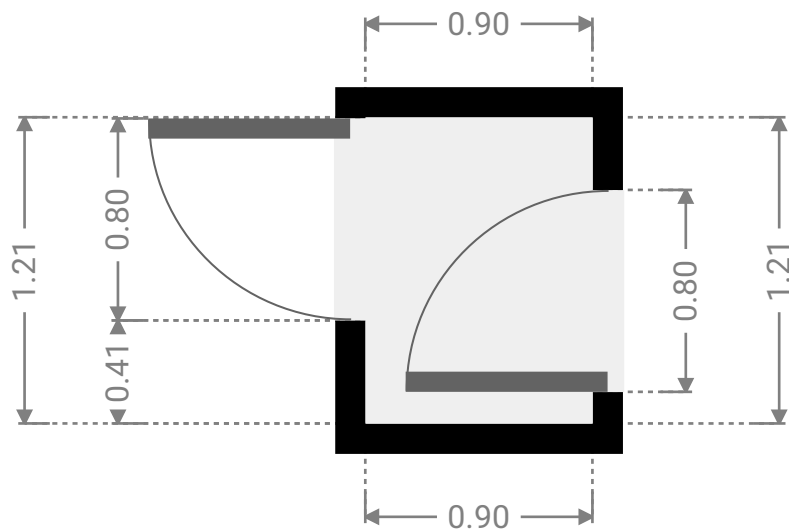
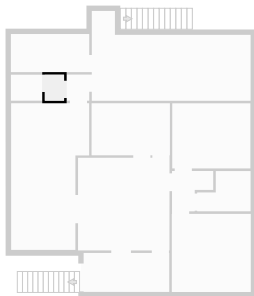



▼ **Toilet**  
1st Floor

WIDTH: 1.47 m • LENGTH: 1.21 m  
AREA: 1.78 m<sup>2</sup> • PERIMETER: 5.36 m

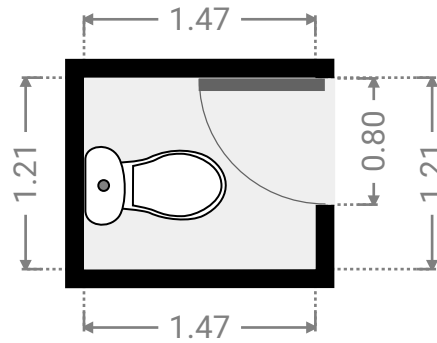
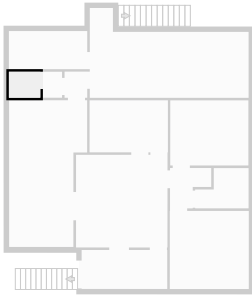

▼ **Hall**  
1st Floor

WIDTH: 1.92 m • LENGTH: 1.88 m  
AREA: 2.76 m<sup>2</sup> • PERIMETER: 7.62 m

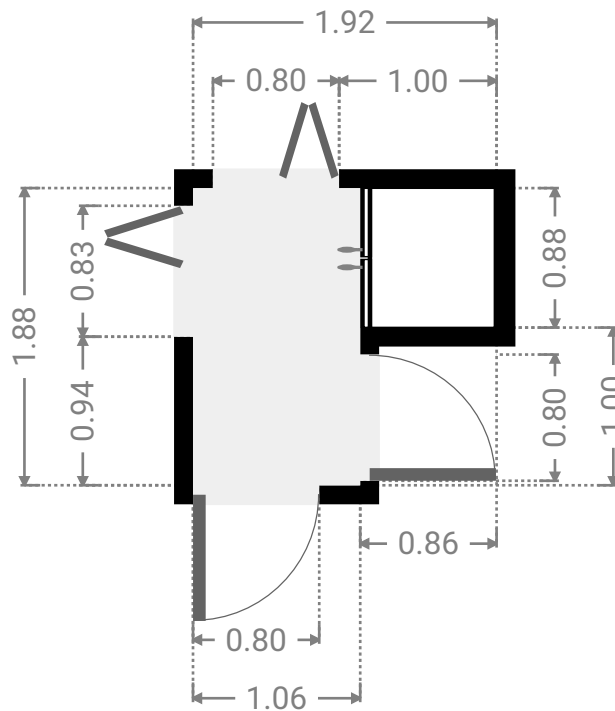
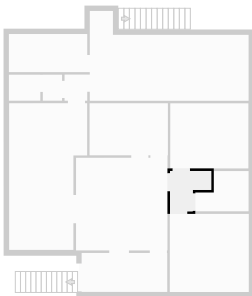

▼ Master Bedroom  
1st Floor

WIDTH: 3.69 m • LENGTH: 3.65 m  
AREA: 13.47 m<sup>2</sup> • PERIMETER: 14.68 m

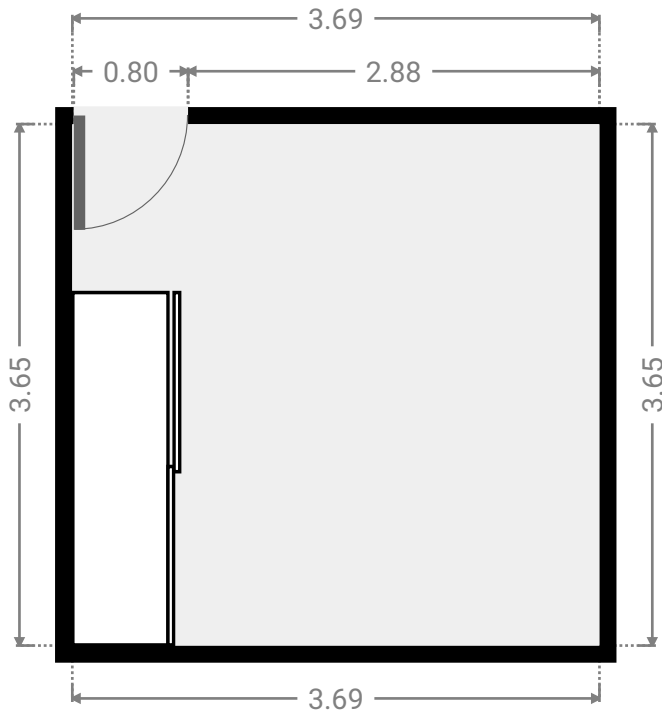
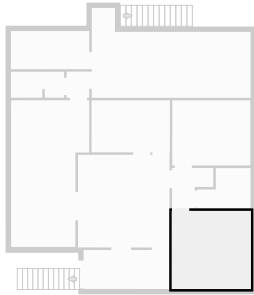

▼ Bathroom  
1st Floor

WIDTH: 2.50 m • LENGTH: 1.88 m  
AREA: 3.82 m<sup>2</sup> • PERIMETER: 8.75 m

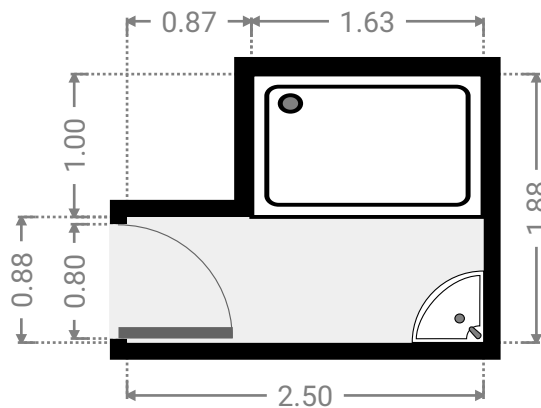
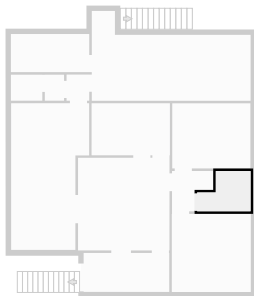

▼ **Bedroom**  
1st Floor

WIDTH: 3.65 m • LENGTH: 3.04 m  
AREA: 11.10 m<sup>2</sup> • PERIMETER: 13.38 m

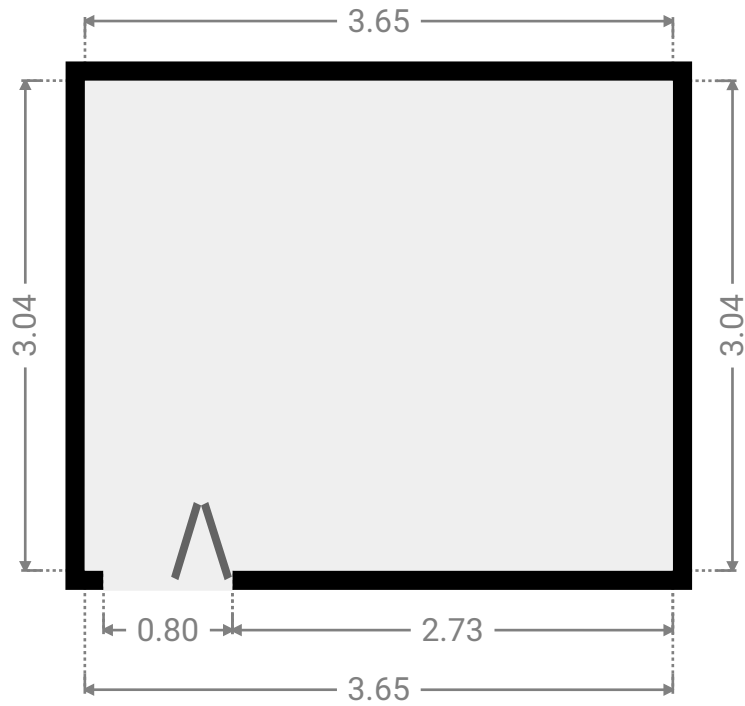
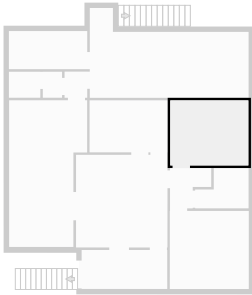

▼ **Bedroom**  
1st Floor

WIDTH: 3.66 m • LENGTH: 2.43 m  
AREA: 8.89 m<sup>2</sup> • PERIMETER: 12.18 m

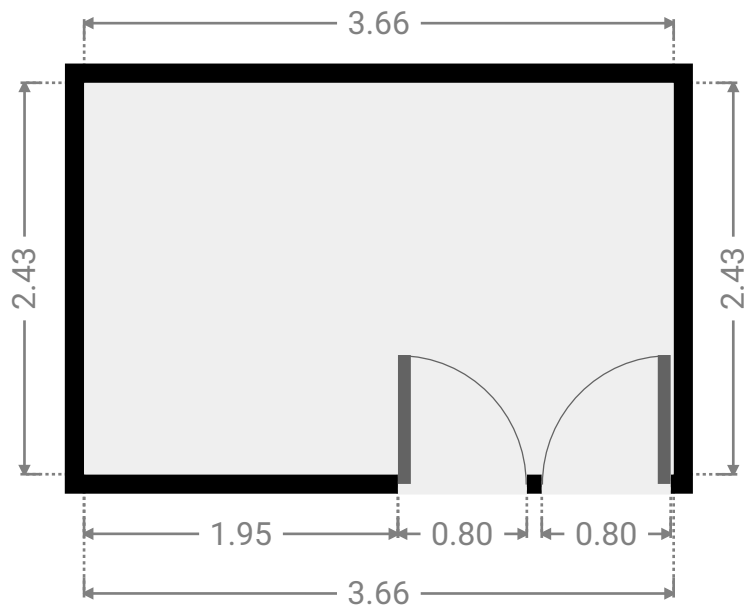
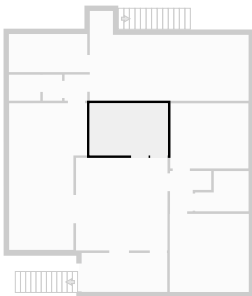

## ▼ Other 1st Floor

WIDTH: 7.42 m • LENGTH: 4.20 m  
AREA: 24.06 m<sup>2</sup> • PERIMETER: 23.23 m

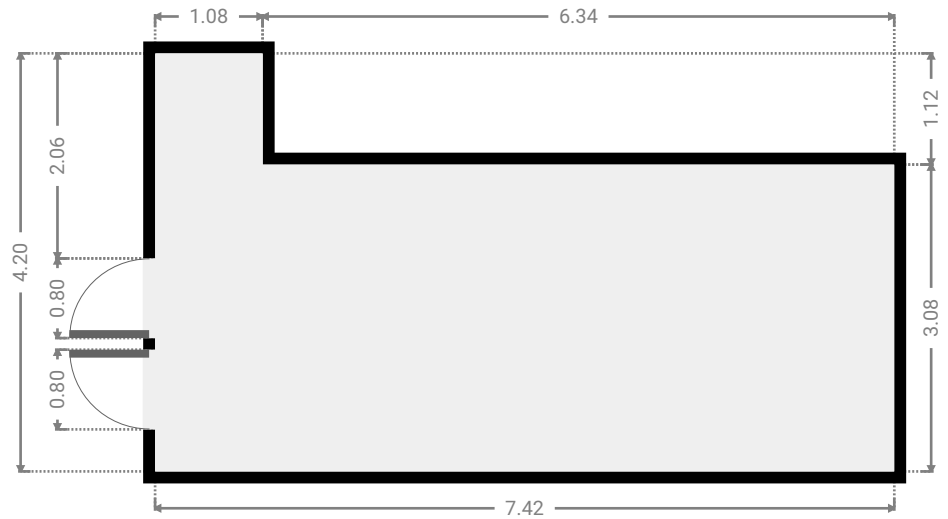
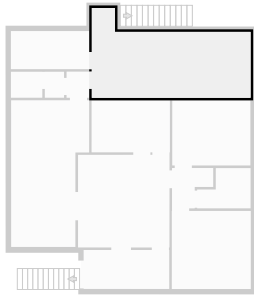

## ▼ Other 1st Floor

WIDTH: 3.66 m • LENGTH: 1.78 m  
AREA: 6.51 m<sup>2</sup> • PERIMETER: 10.88 m

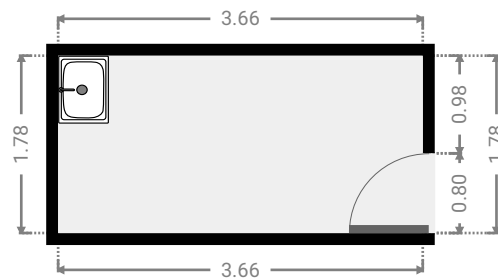
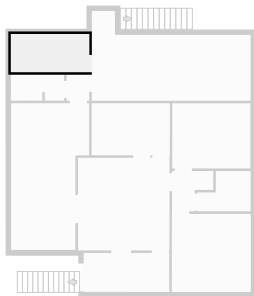

▼ Other  
1st Floor

WIDTH: 4.00 m • LENGTH: 1.82 m  
AREA: 7.28 m<sup>2</sup> • PERIMETER: 11.64 m

