

# 5 Moss Court

**SUBMITTED BY**  
Ray White Rockhampton Casey  
stockers@cqoz.com

---

**CREATED ON**  
2022-11-08

---

**Floors**  
1

---

## ▼ Ground Floor

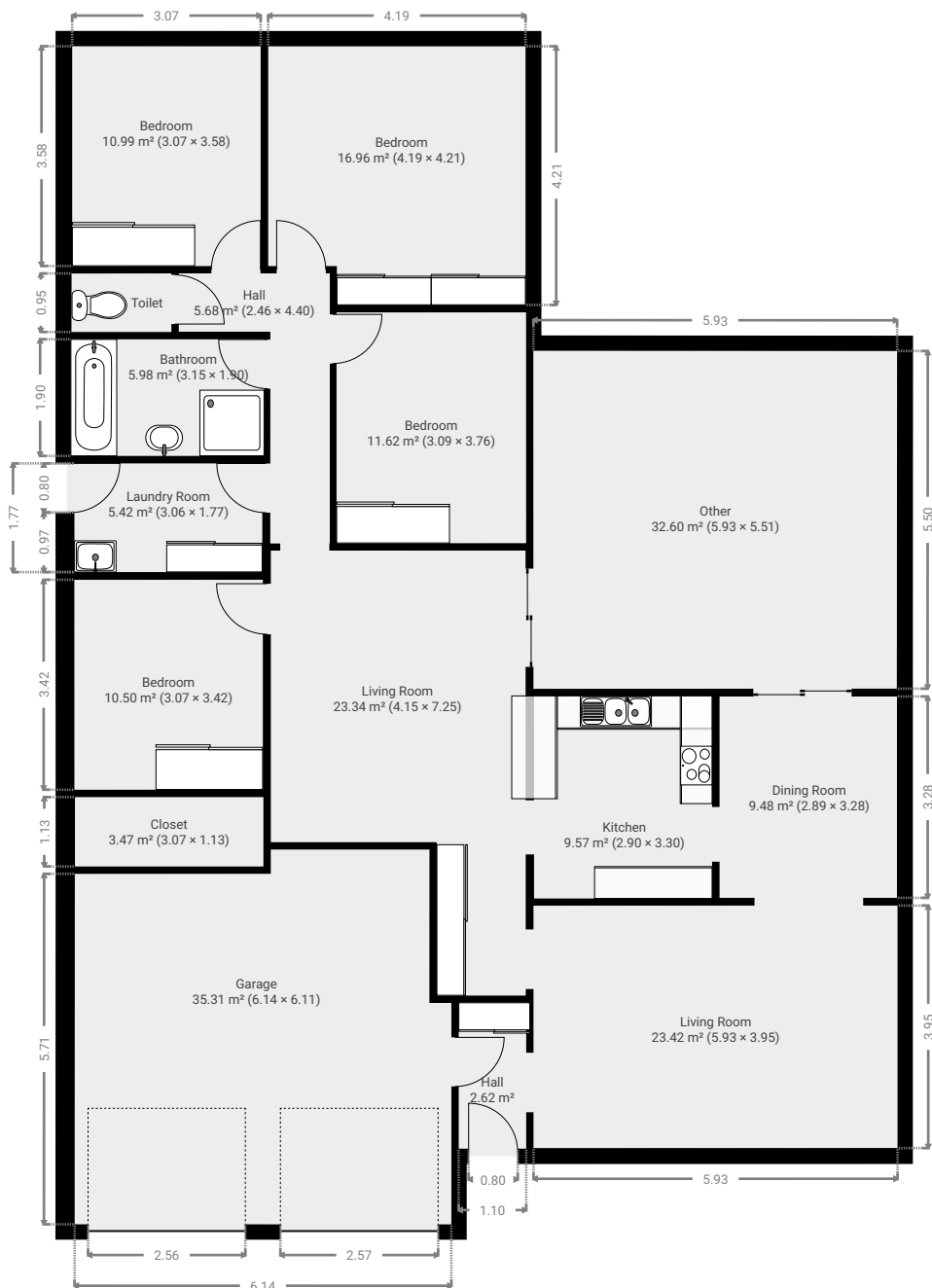
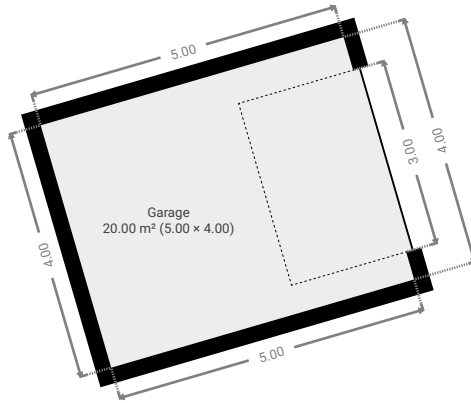

## ▼ Bathroom Ground Floor

WIDTH: 3.15 m • LENGTH: 1.90 m  
AREA: 5.98 m<sup>2</sup> • PERIMETER: 10.10 m

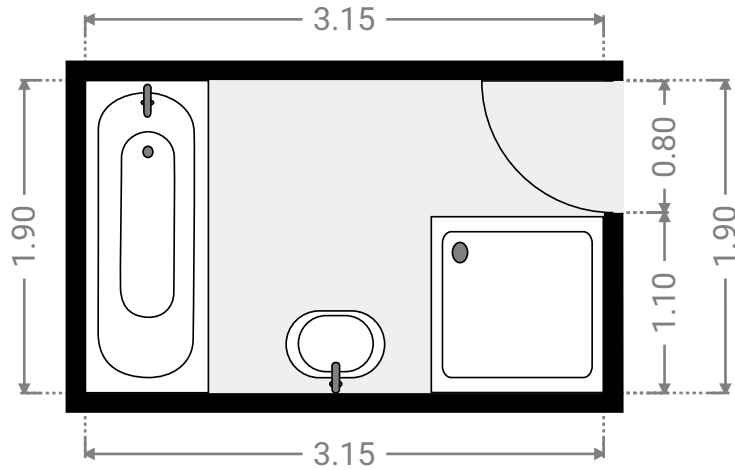
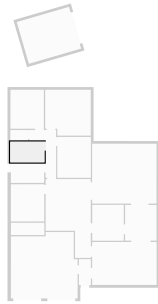

## ▼ Bedroom Ground Floor

WIDTH: 3.07 m • LENGTH: 3.42 m  
AREA: 10.50 m<sup>2</sup> • PERIMETER: 12.98 m

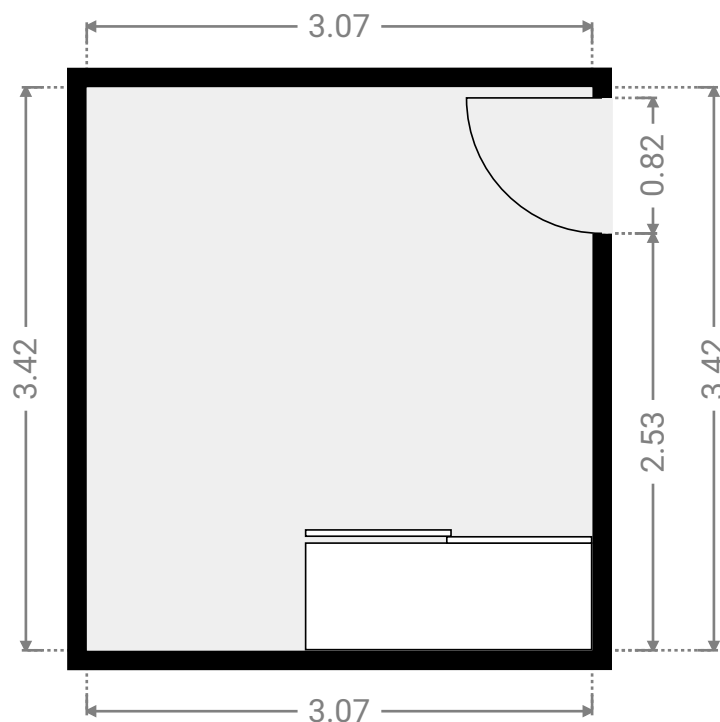
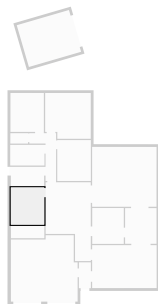

▼ **Bedroom**  
Ground Floor

WIDTH: 3.09 m • LENGTH: 3.76 m  
AREA: 11.62 m<sup>2</sup> • PERIMETER: 13.70 m

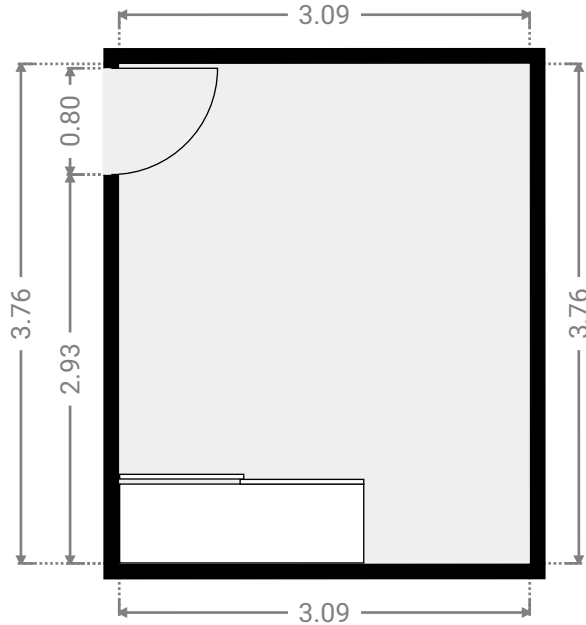
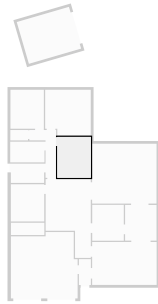

▼ **Bedroom**  
Ground Floor

WIDTH: 4.19 m • LENGTH: 4.21 m  
AREA: 16.96 m<sup>2</sup> • PERIMETER: 16.81 m

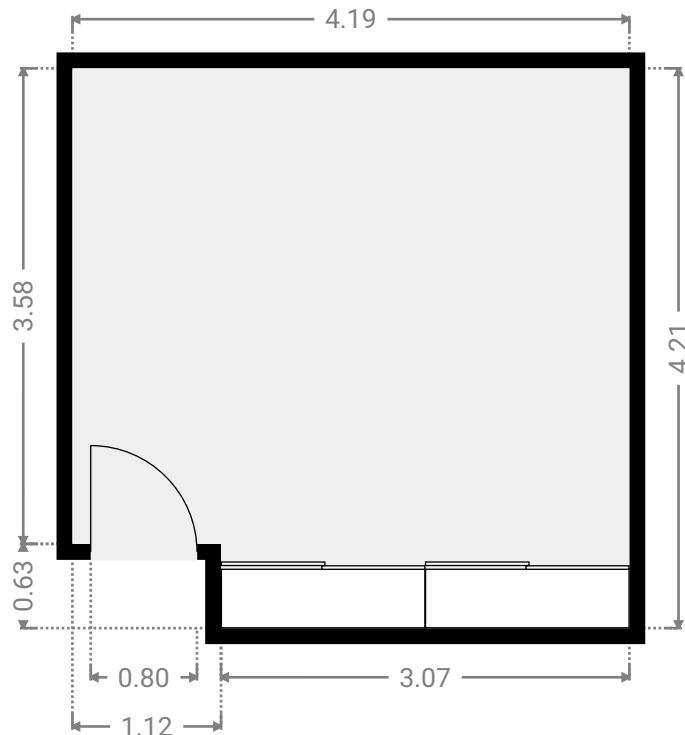
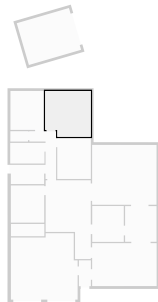

▼ **Bedroom**  
Ground Floor

WIDTH: 3.07 m • LENGTH: 3.58 m  
AREA: 10.99 m<sup>2</sup> • PERIMETER: 13.30 m

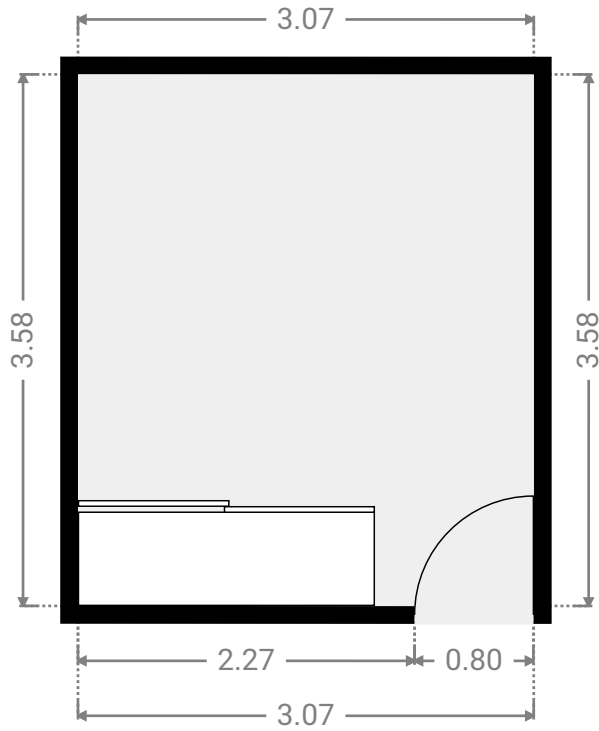
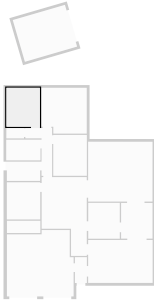

▼ **Closet**  
Ground Floor

WIDTH: 3.07 m • LENGTH: 1.13 m  
AREA: 3.47 m<sup>2</sup> • PERIMETER: 8.40 m

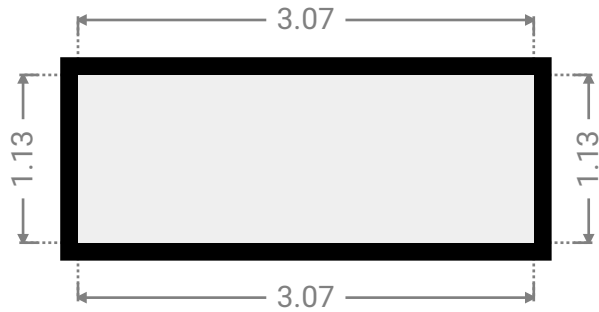
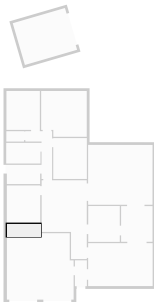

# 5 Moss Court

FLOORS: 1



## ▼ Dining Room Ground Floor

WIDTH: 2.89 m • LENGTH: 3.28 m  
AREA: 9.48 m<sup>2</sup> • PERIMETER: 12.34 m

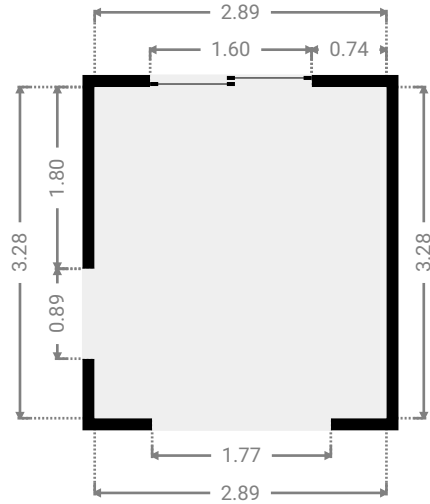
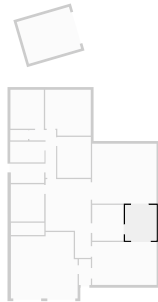

## ▼ Garage Ground Floor

WIDTH: 6.14 m • LENGTH: 6.11 m  
AREA: 35.31 m<sup>2</sup> • PERIMETER: 24.48 m

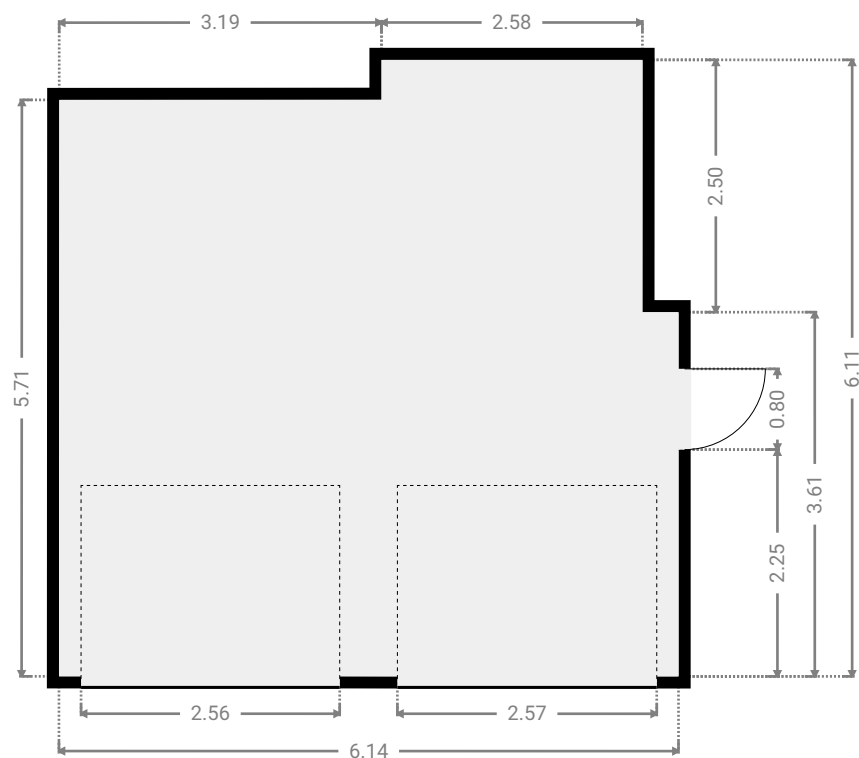
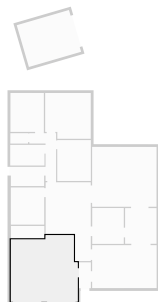

# 5 Moss Court

FLOORS: 1

## ▼ Garage Ground Floor

WIDTH: 5.00 m • LENGTH: 4.00 m  
AREA: 20.00 m<sup>2</sup> • PERIMETER: 18.00 m

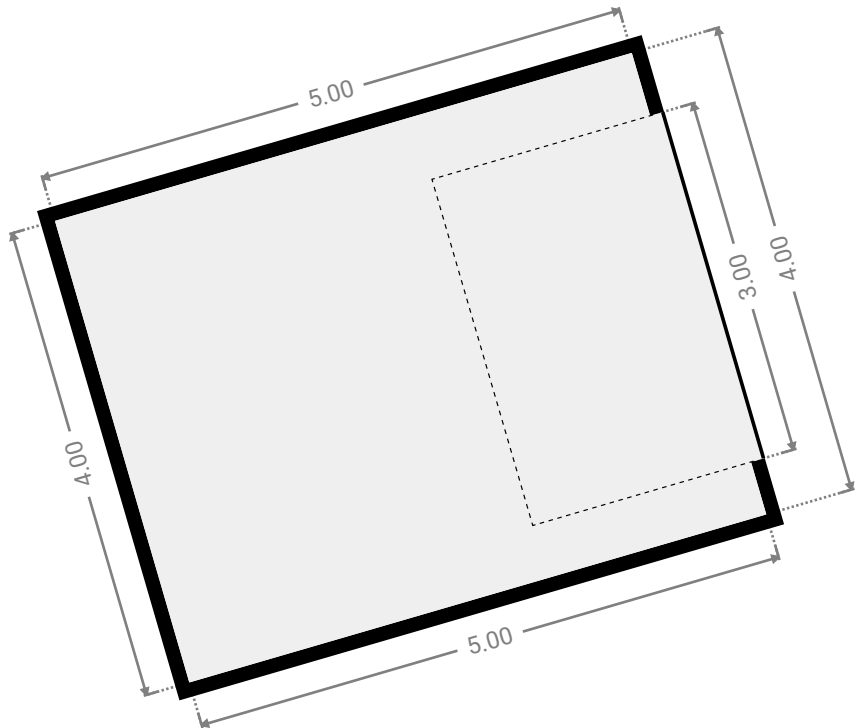
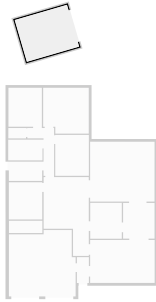

## ▼ Hall Ground Floor

WIDTH: 1.10 m • LENGTH: 2.38 m  
AREA: 2.62 m<sup>2</sup> • PERIMETER: 6.96 m

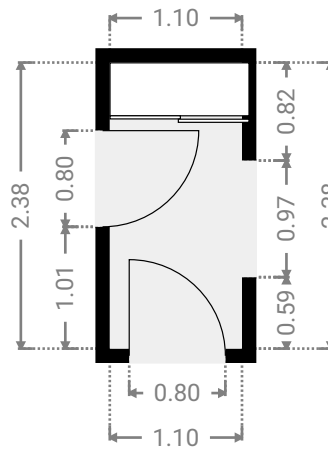
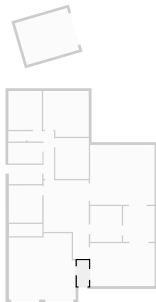

▼ **Hall**  
Ground Floor

WIDTH: 2.46 m • LENGTH: 4.40 m  
AREA: 5.68 m<sup>2</sup> • PERIMETER: 13.72 m

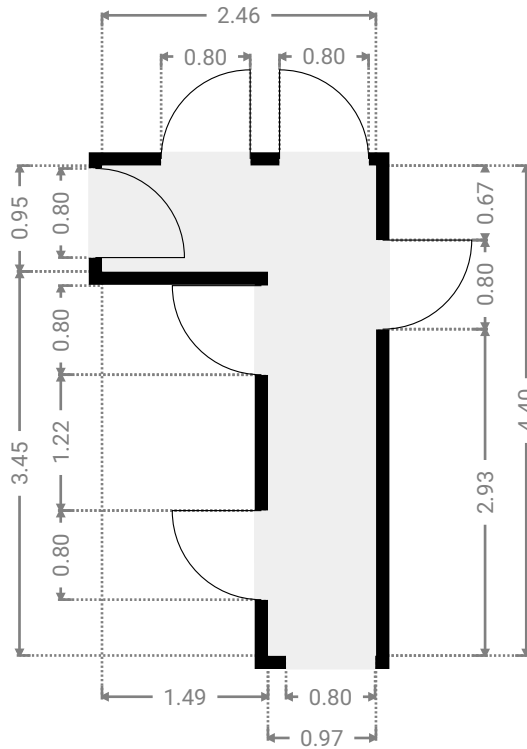
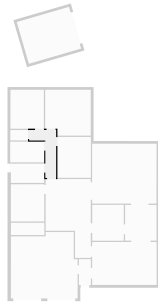

▼ **Kitchen**  
Ground Floor

WIDTH: 2.90 m • LENGTH: 3.30 m  
AREA: 9.57 m<sup>2</sup> • PERIMETER: 12.40 m

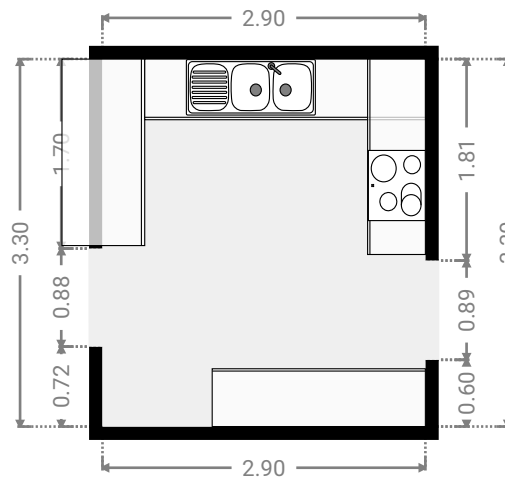
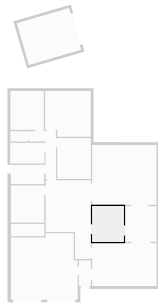



# 5 Moss Court

FLOORS: 1



## ▼ Laundry Room Ground Floor

WIDTH: 3.06 m • LENGTH: 1.77 m  
AREA: 5.42 m<sup>2</sup> • PERIMETER: 9.66 m

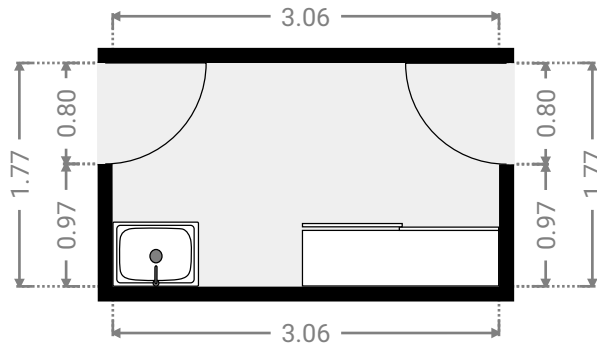

## ▼ Living Room Ground Floor

WIDTH: 5.93 m • LENGTH: 3.95 m  
AREA: 23.42 m<sup>2</sup> • PERIMETER: 19.76 m

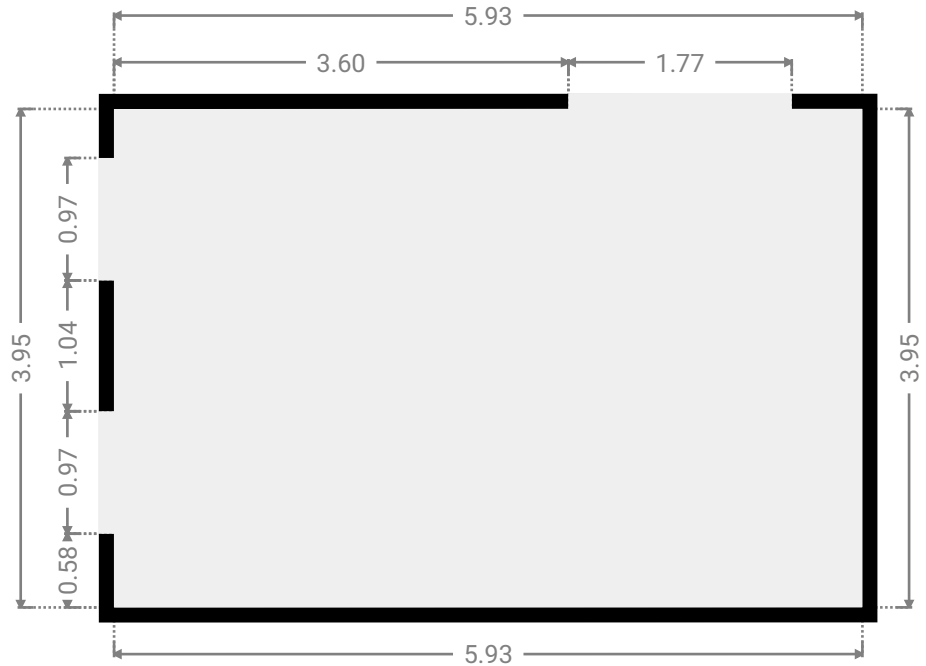
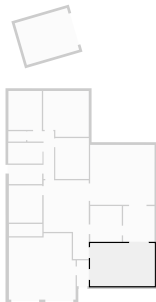

# 5 Moss Court

FLOORS: 1

## ▼ Living Room Ground Floor

WIDTH: 4.15 m • LENGTH: 7.25 m  
AREA: 23.34 m<sup>2</sup> • PERIMETER: 22.80 m

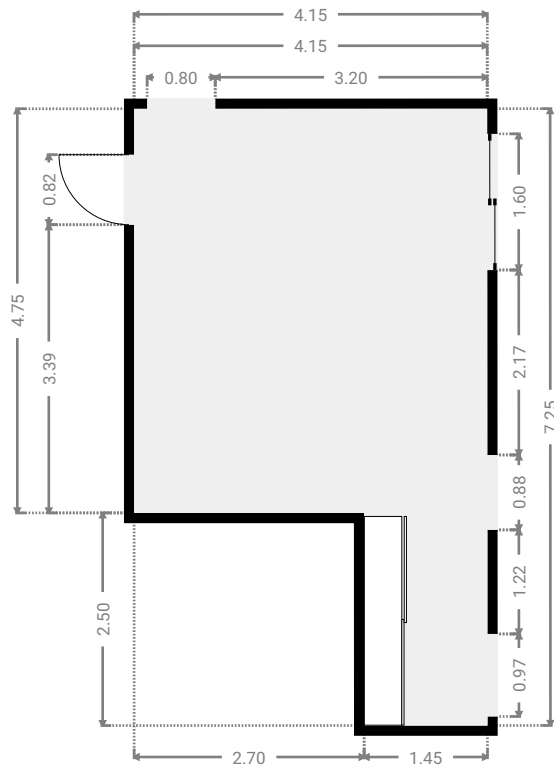
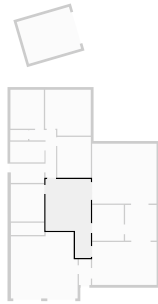

## ▼ Other Ground Floor

WIDTH: 5.93 m • LENGTH: 5.51 m  
AREA: 32.60 m<sup>2</sup> • PERIMETER: 22.85 m

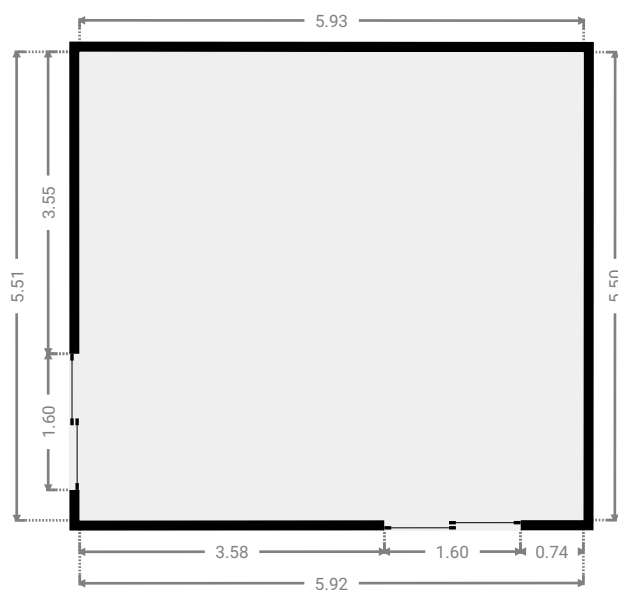
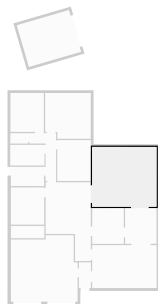

## ▼ Toilet Ground Floor

WIDTH: 1.63 m • LENGTH: 0.96 m  
AREA: 1.55 m<sup>2</sup> • PERIMETER: 5.16 m

