

5 Mcgrath Street

Ground Floor

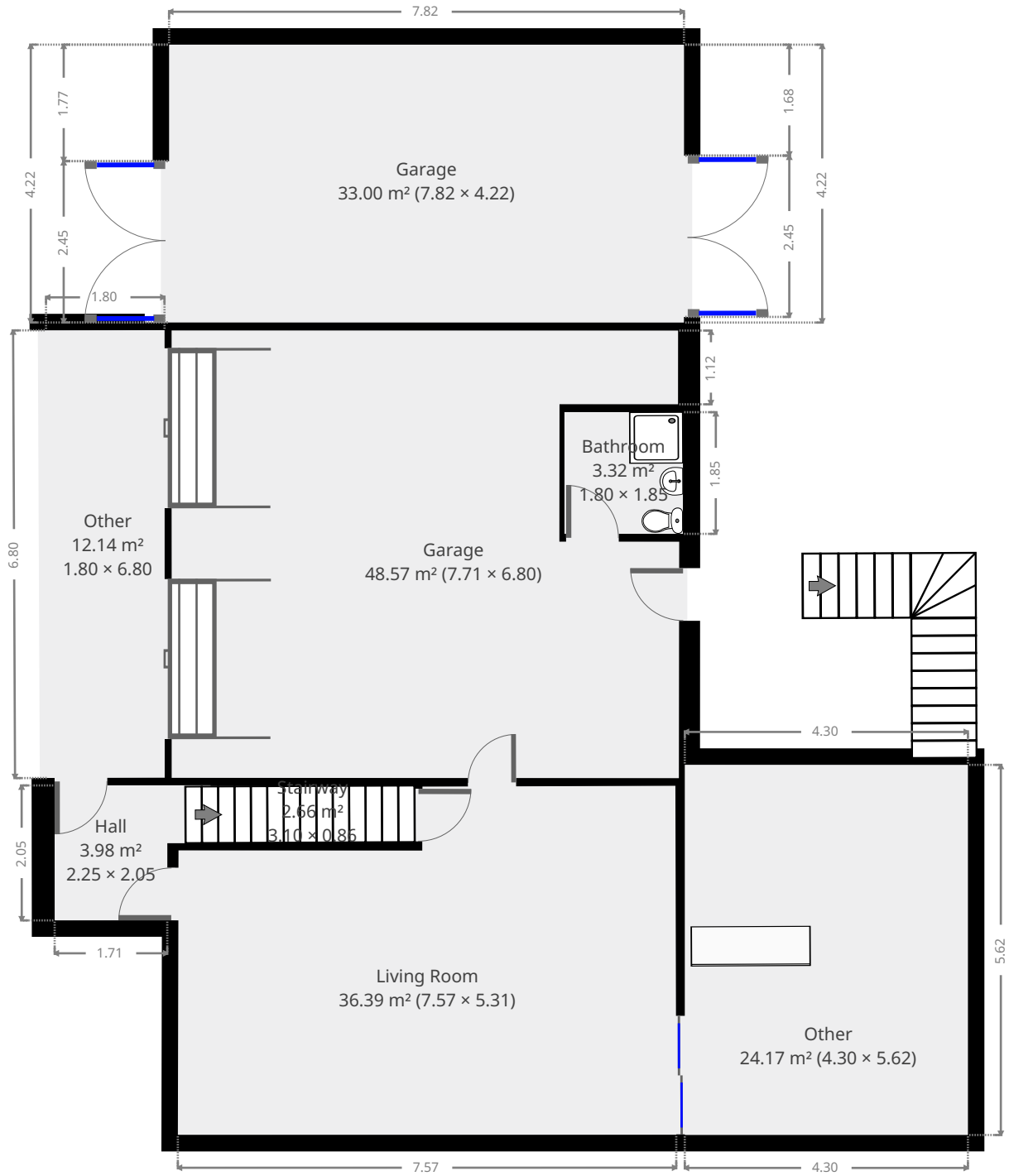

THIS FLOORPLAN IS PROVIDED WITHOUT WARRANTY OF ANY KIND. SENSOPIA DISCLAIMS ANY WARRANTY INCLUDING, WITHOUT LIMITATION, SATISFACTORY QUALITY OR ACCURACY OF DIMENSIONS.



5 Mcgrath Street

Hall

Width: 2.05 m
 Length: 2.25 m
 Area: 3.98 m²
 Perimeter: 8.60 m

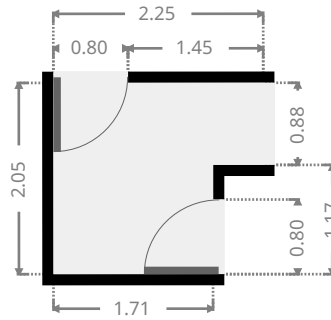
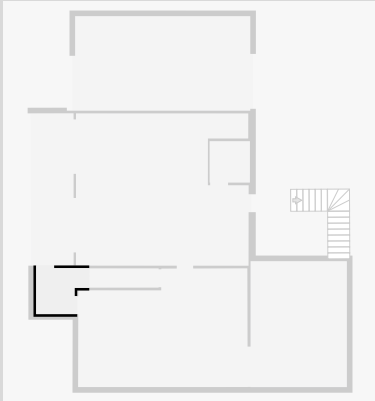

Living Room

Width: 5.31 m
 Length: 7.57 m
 Area: 36.39 m²
 Perimeter: 25.70 m

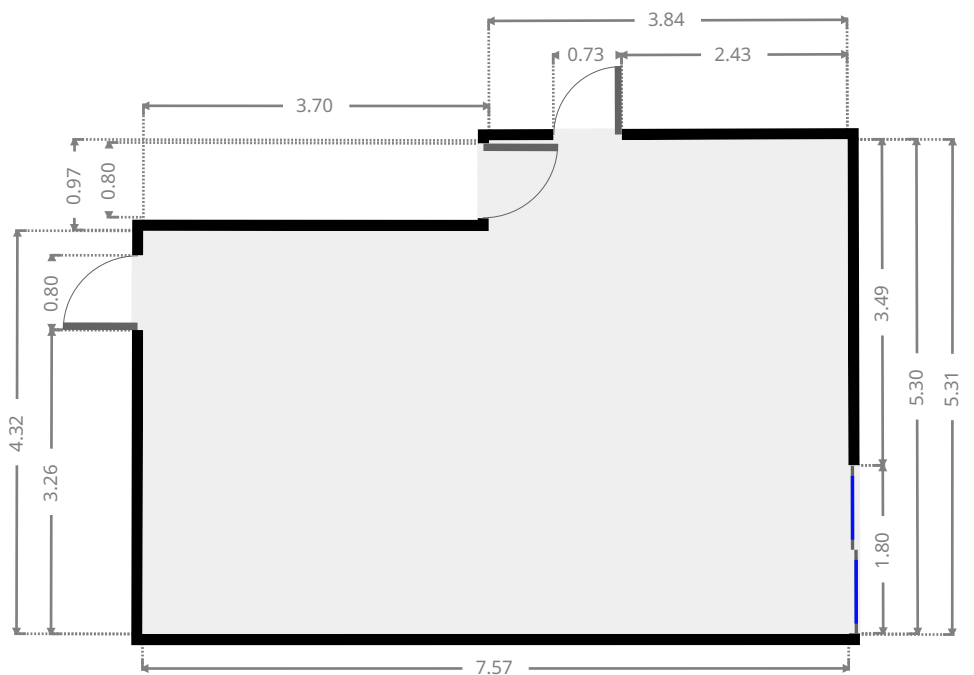
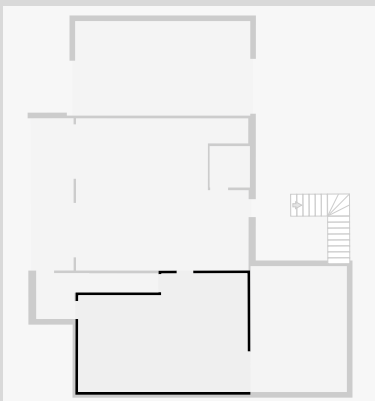

THIS FLOORPLAN IS PROVIDED WITHOUT WARRANTY OF ANY KIND. SENSOPIA DISCLAIMS ANY WARRANTY INCLUDING, WITHOUT LIMITATION, SATISFACTORY QUALITY OR ACCURACY OF DIMENSIONS.



5 Mcgrath Street

Stairway

Width: 0.86 m
 Length: 3.10 m
 Area: 2.66 m²
 Perimeter: 7.91 m

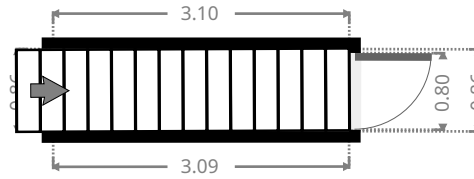
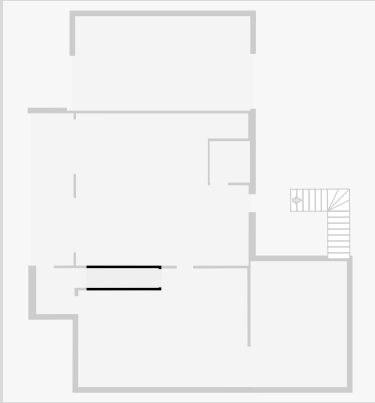

Garage

Width: 6.80 m
 Length: 7.71 m
 Area: 48.57 m²
 Perimeter: 32.61 m

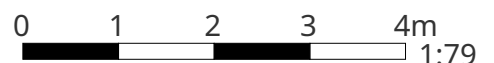
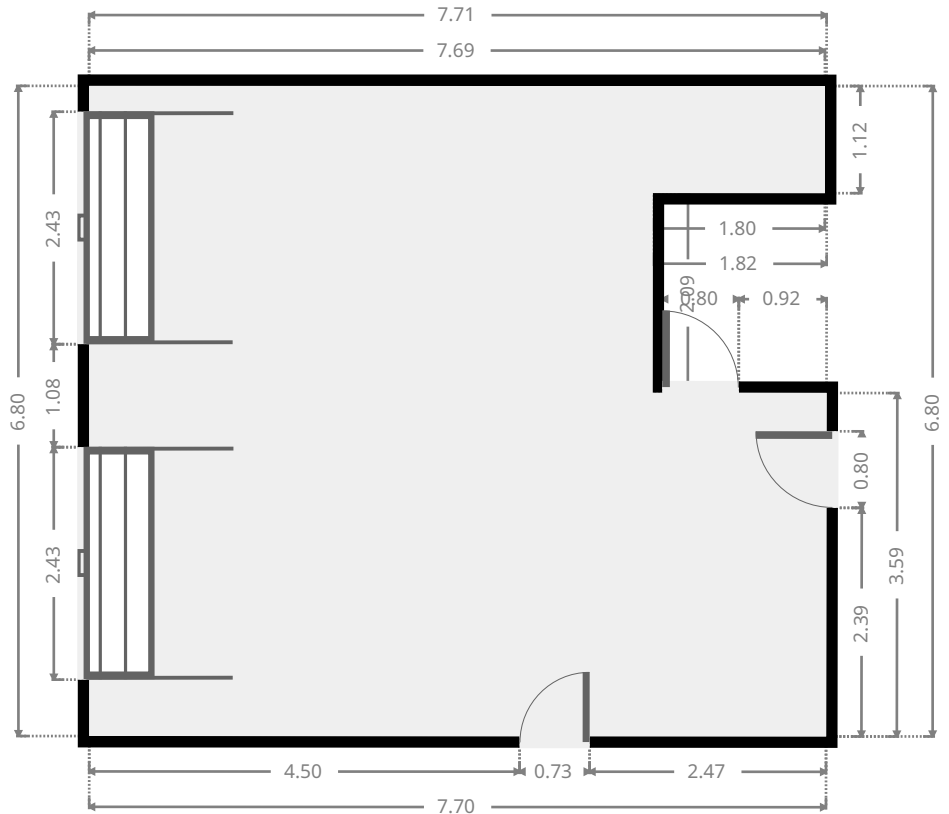
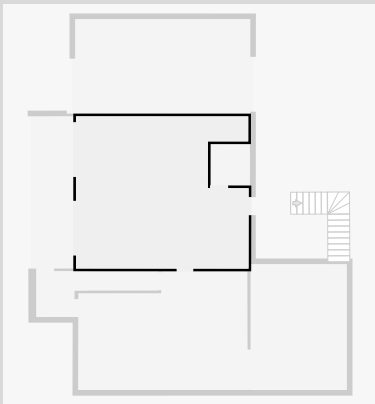

THIS FLOORPLAN IS PROVIDED WITHOUT WARRANTY OF ANY KIND. SENSOPIA DISCLAIMS ANY WARRANTY INCLUDING, WITHOUT LIMITATION, SATISFACTORY QUALITY OR ACCURACY OF DIMENSIONS.

5 Mcgrath Street

Bathroom

Width: 1.80 m
Length: 1.85 m
Area: 3.32 m²
Perimeter: 7.29 m

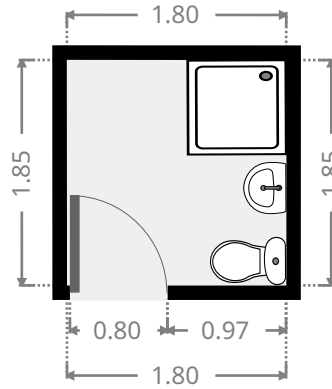
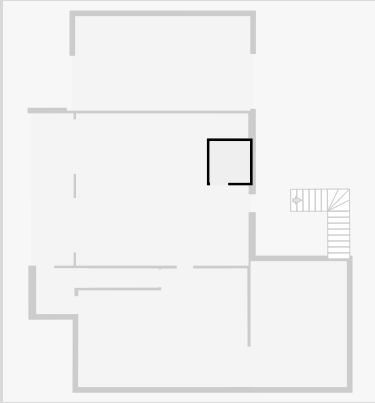

Other

Width: 4.30 m
Length: 5.62 m
Area: 24.17 m²
Perimeter: 19.84 m

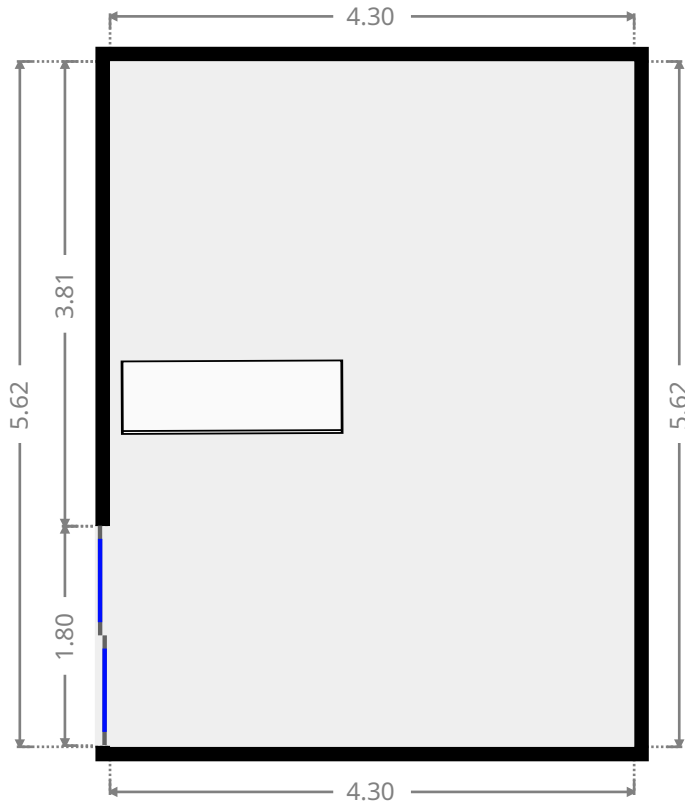
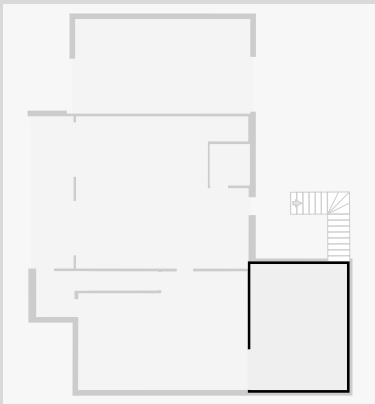

THIS FLOORPLAN IS PROVIDED WITHOUT WARRANTY OF ANY KIND. SENSOPIA DISCLAIMS ANY WARRANTY INCLUDING, WITHOUT LIMITATION, SATISFACTORY QUALITY OR ACCURACY OF DIMENSIONS.

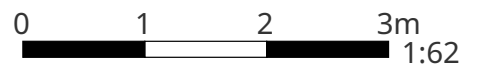

5 Mcgrath Street

Garage

Width: 4.22 m
 Length: 7.82 m
 Area: 33.00 m²
 Perimeter: 24.08 m

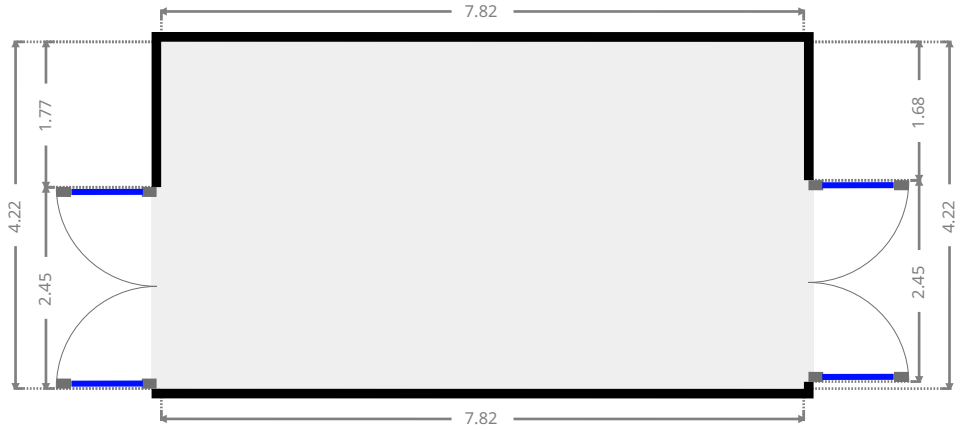
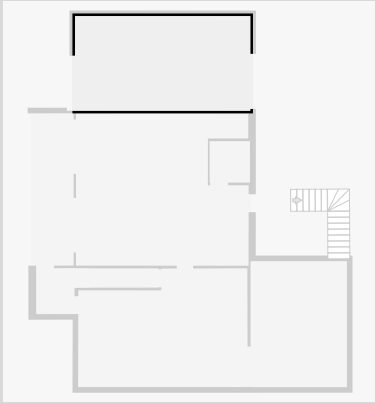

Other

Width: 1.80 m
 Length: 6.80 m
 Area: 12.14 m²
 Perimeter: 17.17 m

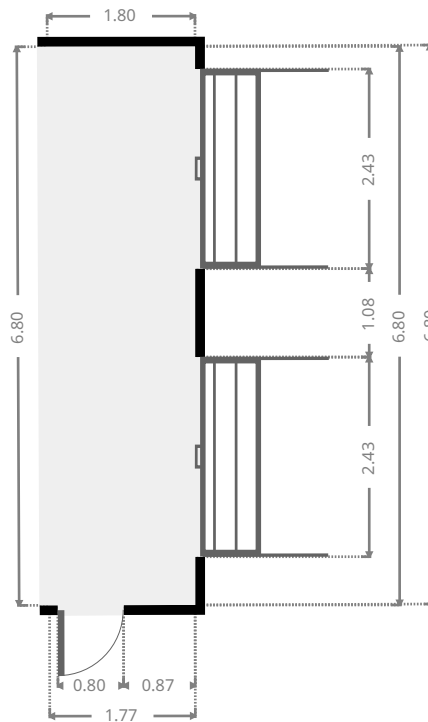
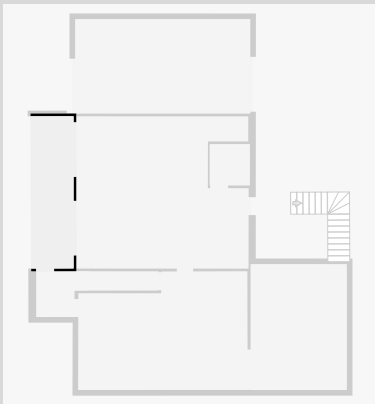

THIS FLOORPLAN IS PROVIDED WITHOUT WARRANTY OF ANY KIND. SENSOPIA DISCLAIMS ANY WARRANTY INCLUDING, WITHOUT LIMITATION, SATISFACTORY QUALITY OR ACCURACY OF DIMENSIONS.

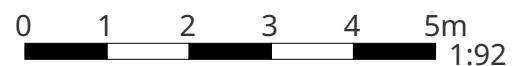

5 Mcgrath Street

1st Floor

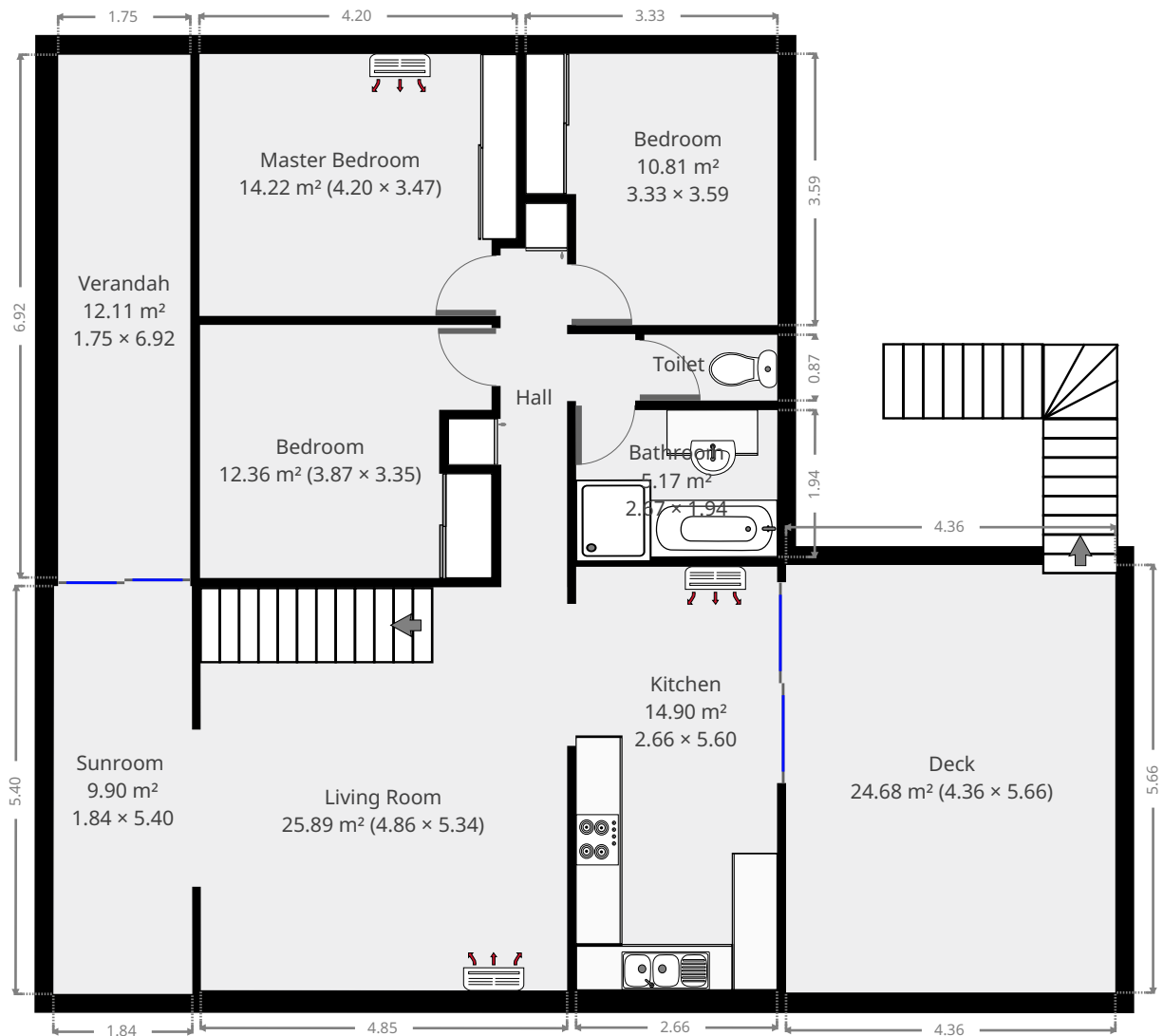

THIS FLOORPLAN IS PROVIDED WITHOUT WARRANTY OF ANY KIND. SENSOPIA DISCLAIMS ANY WARRANTY INCLUDING, WITHOUT LIMITATION, SATISFACTORY QUALITY OR ACCURACY OF DIMENSIONS.

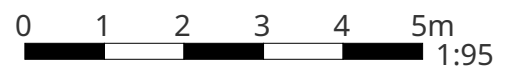

5 Mcgrath Street

Living Room

Width: 4.86 m
 Length: 5.34 m
 Area: 25.89 m²
 Perimeter: 20.37 m

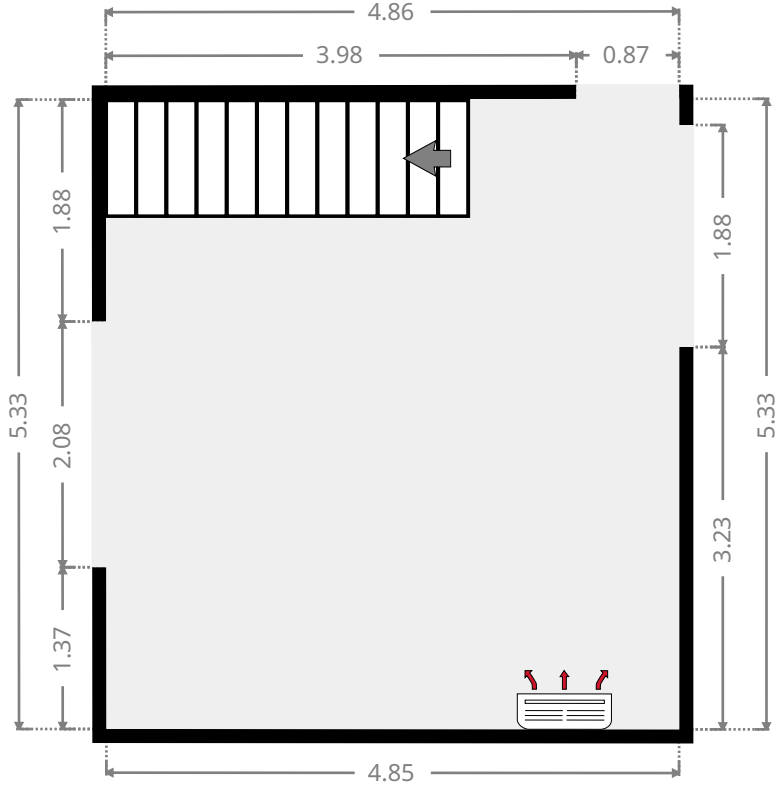
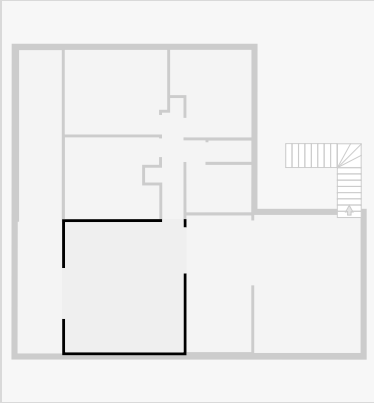

Sunroom

Width: 1.84 m
 Length: 5.40 m
 Area: 9.90 m²
 Perimeter: 14.46 m

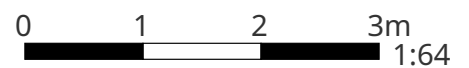
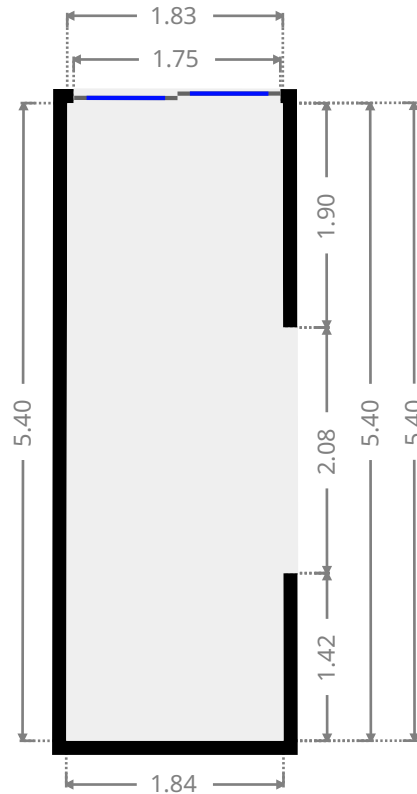
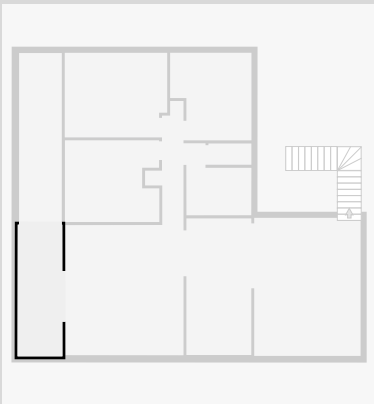

THIS FLOORPLAN IS PROVIDED WITHOUT WARRANTY OF ANY KIND. SENSOPIA DISCLAIMS ANY WARRANTY INCLUDING, WITHOUT LIMITATION, SATISFACTORY QUALITY OR ACCURACY OF DIMENSIONS.

5 Mcgrath Street

Verandah

Width: 1.75 m
Length: 6.92 m
Area: 12.11 m²
Perimeter: 17.34 m

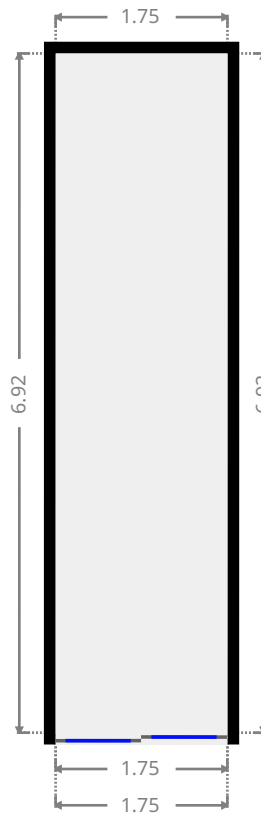
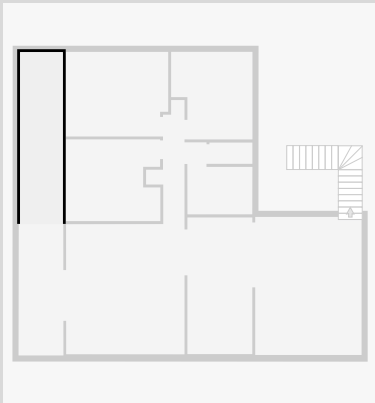

Kitchen

Width: 2.66 m
Length: 5.60 m
Area: 14.90 m²
Perimeter: 16.52 m

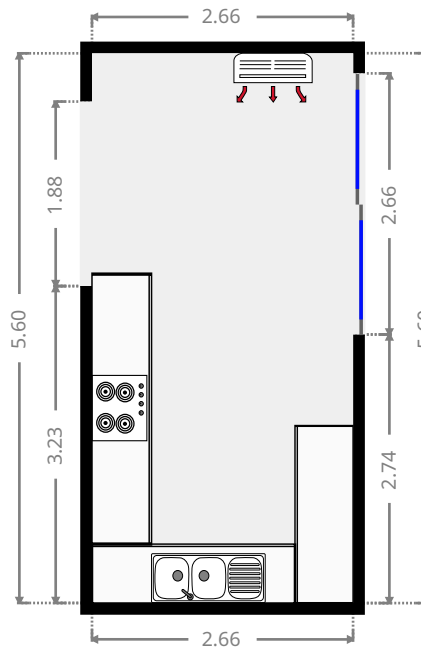
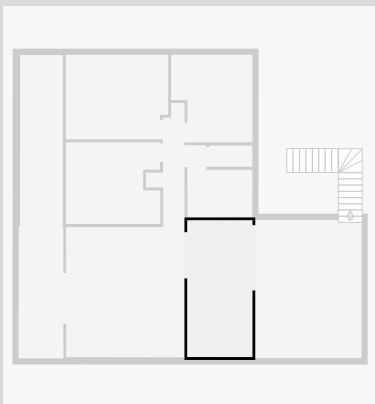

THIS FLOORPLAN IS PROVIDED WITHOUT WARRANTY OF ANY KIND. SENSOPIA DISCLAIMS ANY WARRANTY INCLUDING, WITHOUT LIMITATION, SATISFACTORY QUALITY OR ACCURACY OF DIMENSIONS.



5 Mcgrath Street

Deck

Width: 4.36 m
 Length: 5.66 m
 Area: 24.68 m²
 Perimeter: 20.04 m

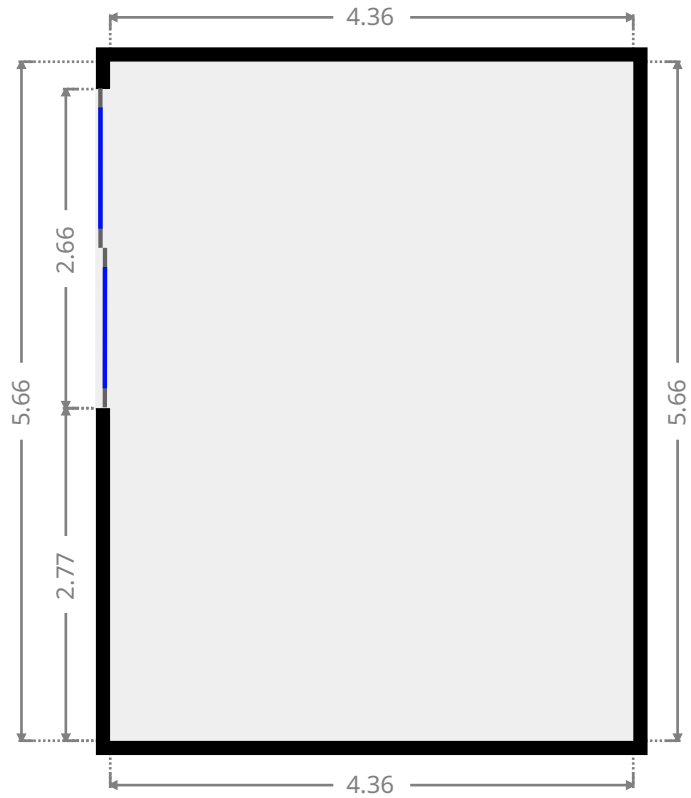
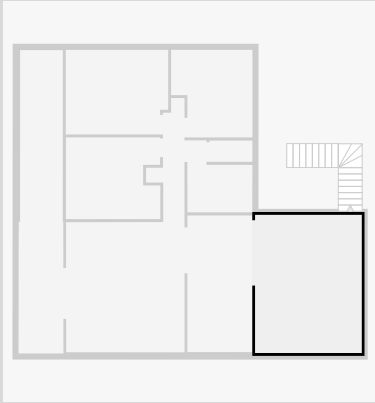

Hall

Width: 2.48 m
 Length: 4.96 m
 Area: 5.37 m²
 Perimeter: 14.88 m

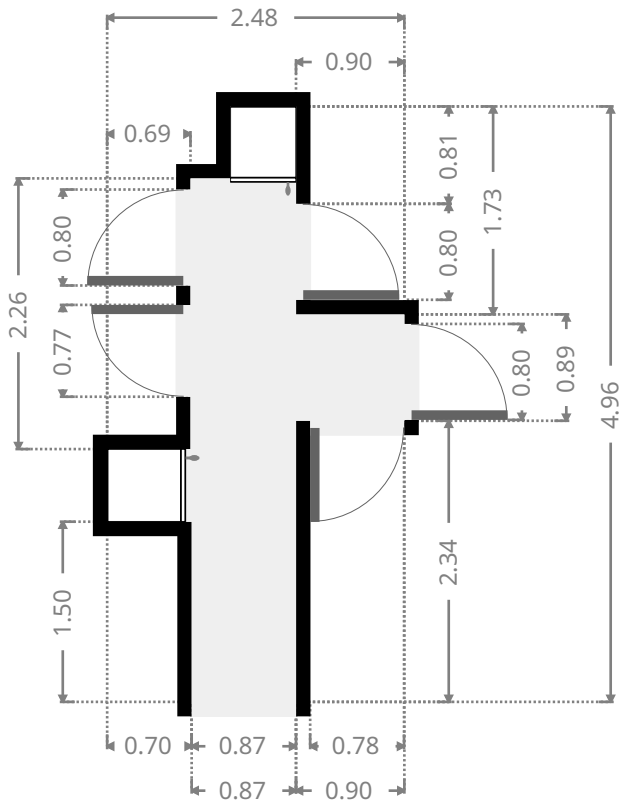
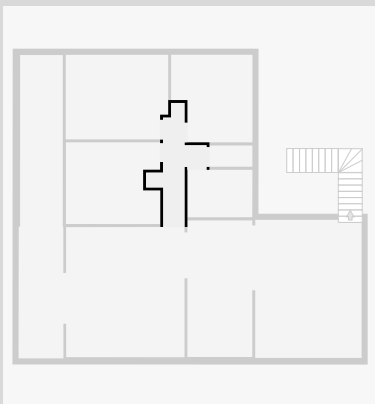

THIS FLOORPLAN IS PROVIDED WITHOUT WARRANTY OF ANY KIND. SENSOPIA DISCLAIMS ANY WARRANTY INCLUDING, WITHOUT LIMITATION, SATISFACTORY QUALITY OR ACCURACY OF DIMENSIONS.

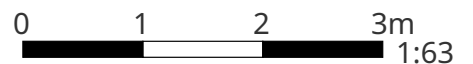

5 Mcgrath Street

Bedroom

Width: 3.35 m
 Length: 3.87 m
 Area: 12.36 m²
 Perimeter: 15.83 m

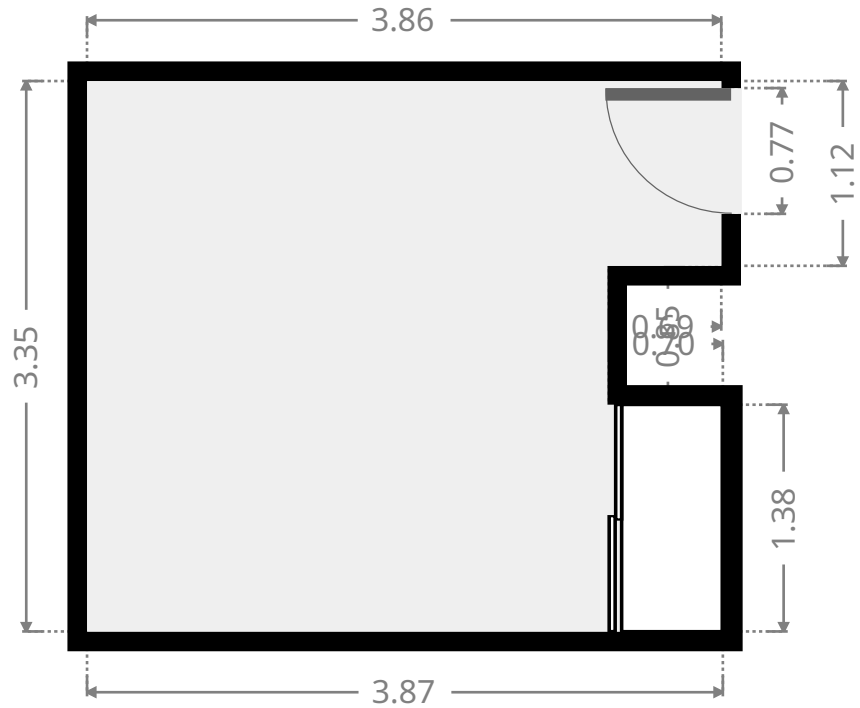
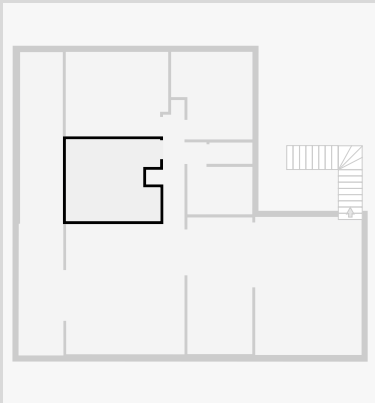

Master Bedroom

Width: 3.47 m
 Length: 4.20 m
 Area: 14.22 m²
 Perimeter: 15.33 m

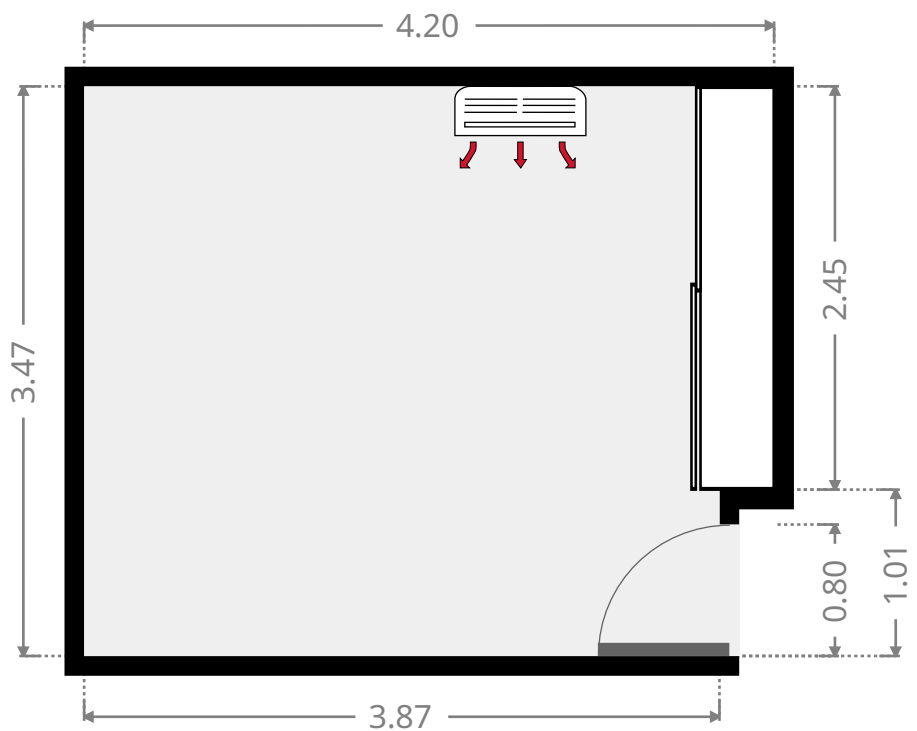
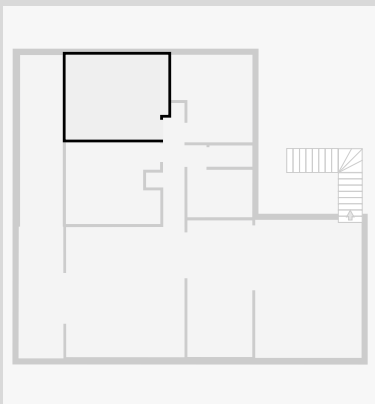

THIS FLOORPLAN IS PROVIDED WITHOUT WARRANTY OF ANY KIND. SENSOPIA DISCLAIMS ANY WARRANTY INCLUDING, WITHOUT LIMITATION, SATISFACTORY QUALITY OR ACCURACY OF DIMENSIONS.

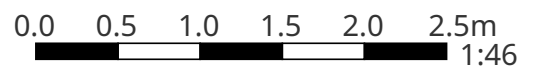

5 Mcgrath Street

Bedroom

Width: 3.33 m
Length: 3.59 m
Area: 10.81 m²
Perimeter: 13.85 m

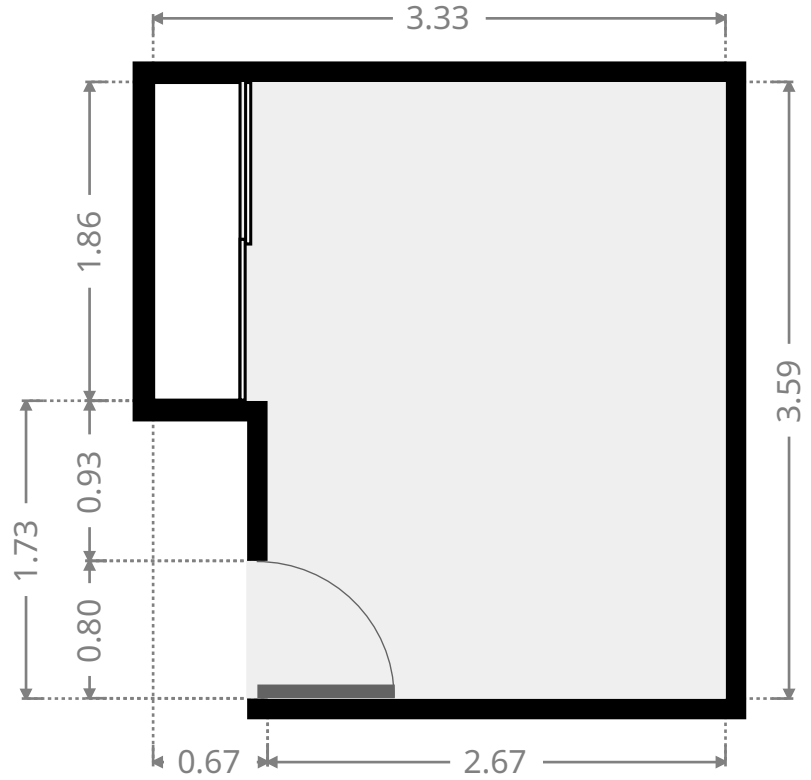
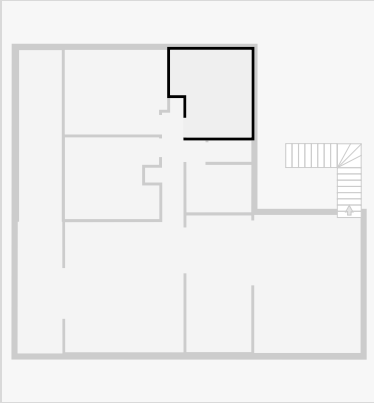

Toilet / Half Bath

Width: 0.87 m
Length: 1.76 m
Area: 1.53 m²
Perimeter: 5.26 m

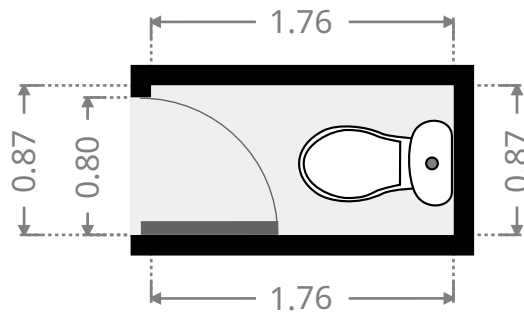
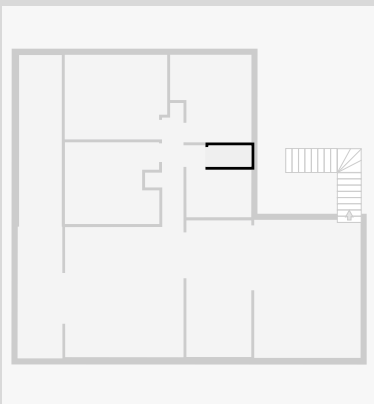

5 Mcgrath Street

Bathroom

Width: 1.94 m
Length: 2.67 m
Area: 5.17 m²
Perimeter: 9.21 m

