

5 Maclyn Avenue

Ground Floor

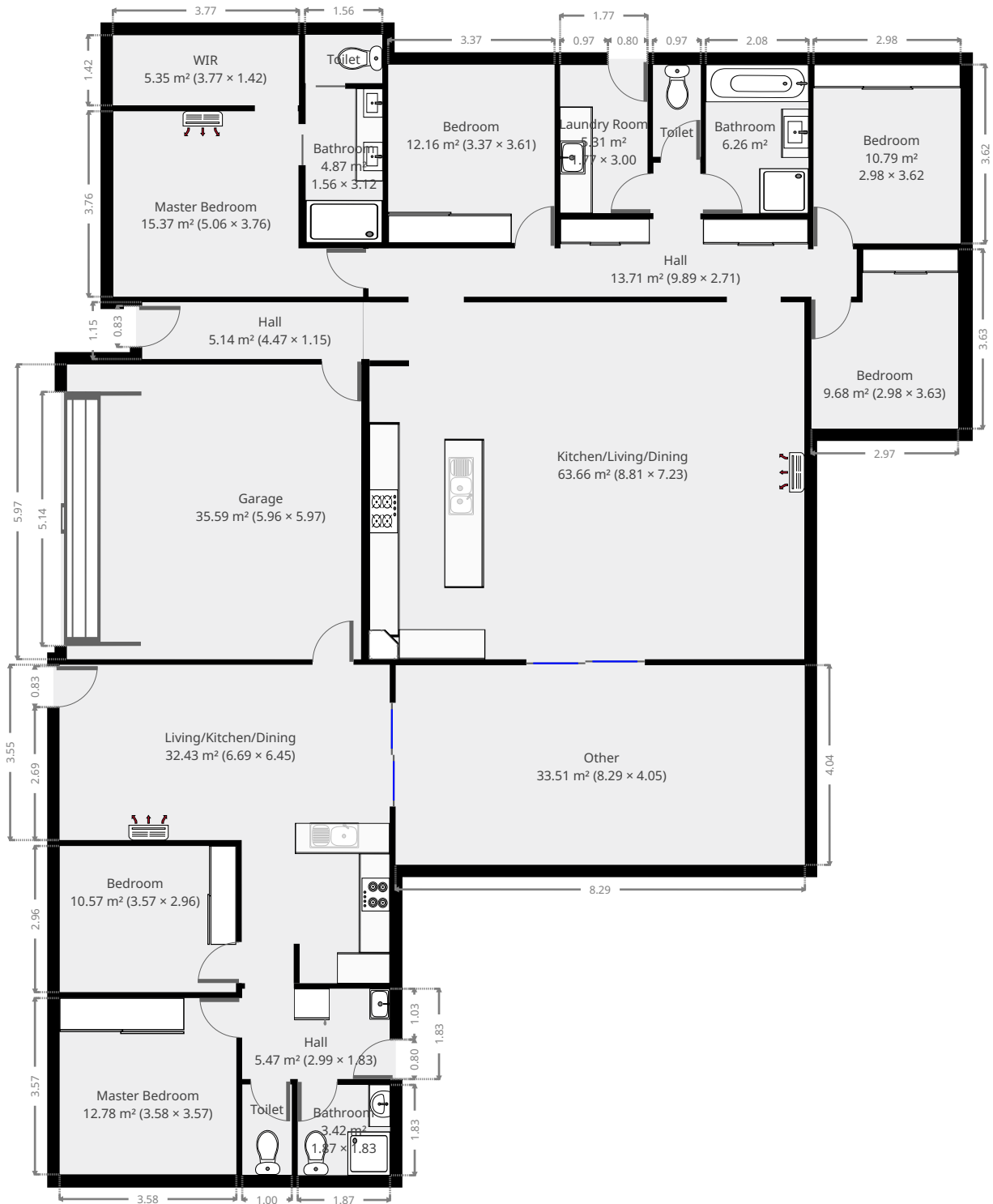

THIS FLOORPLAN IS PROVIDED WITHOUT WARRANTY OF ANY KIND. SENSOPIA DISCLAIMS ANY WARRANTY INCLUDING, WITHOUT LIMITATION, SATISFACTORY QUALITY OR ACCURACY OF DIMENSIONS.



5 Maclyn Avenue

Master Bedroom

Width: 3.76 m
 Length: 5.06 m
 Area: 15.37 m²
 Perimeter: 17.63 m

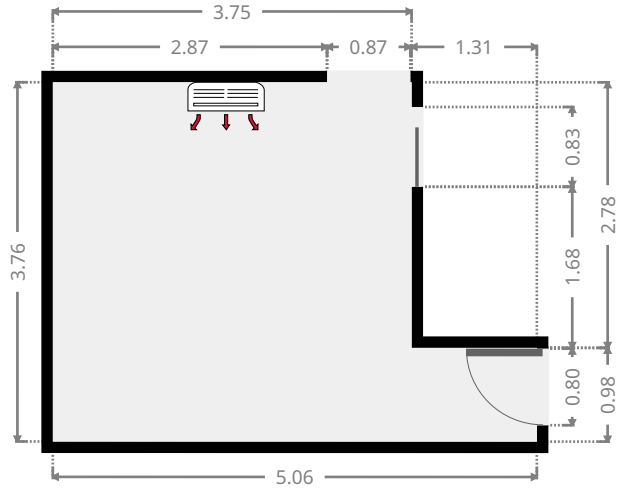
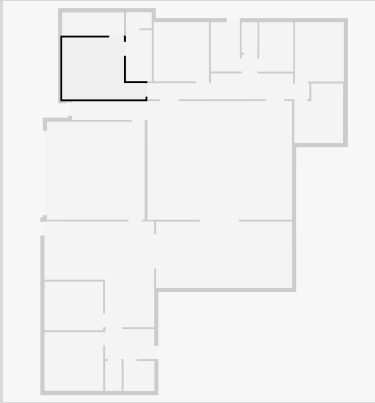

Other

Width: 4.05 m
 Length: 8.29 m
 Area: 33.51 m²
 Perimeter: 24.66 m

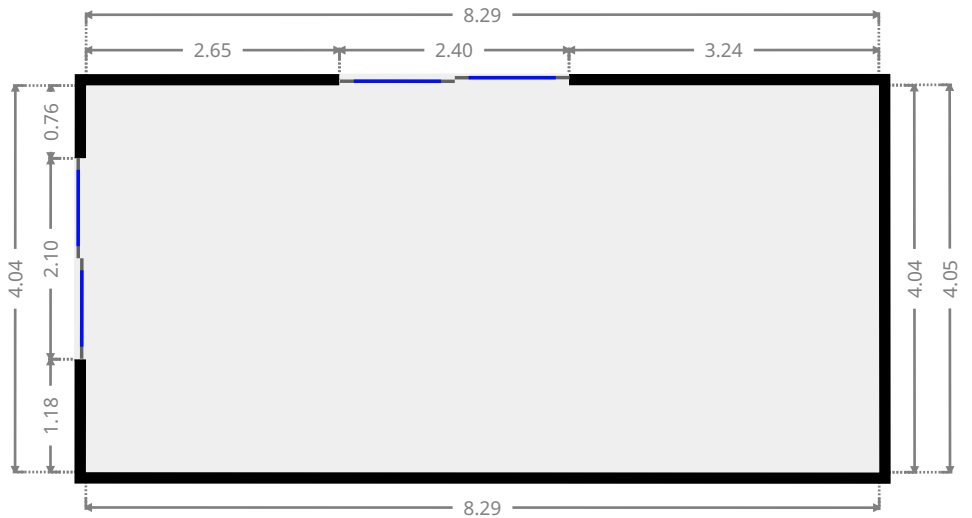
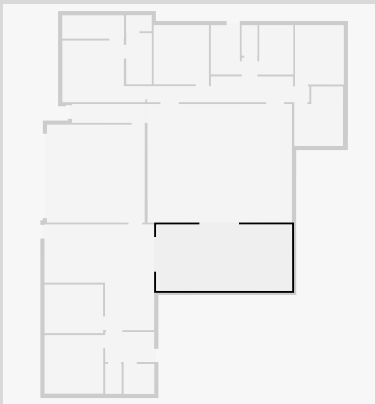

5 Maclyn Avenue

Bedroom

Width: 2.98 m
 Length: 3.63 m
 Area: 9.68 m²
 Perimeter: 13.21 m

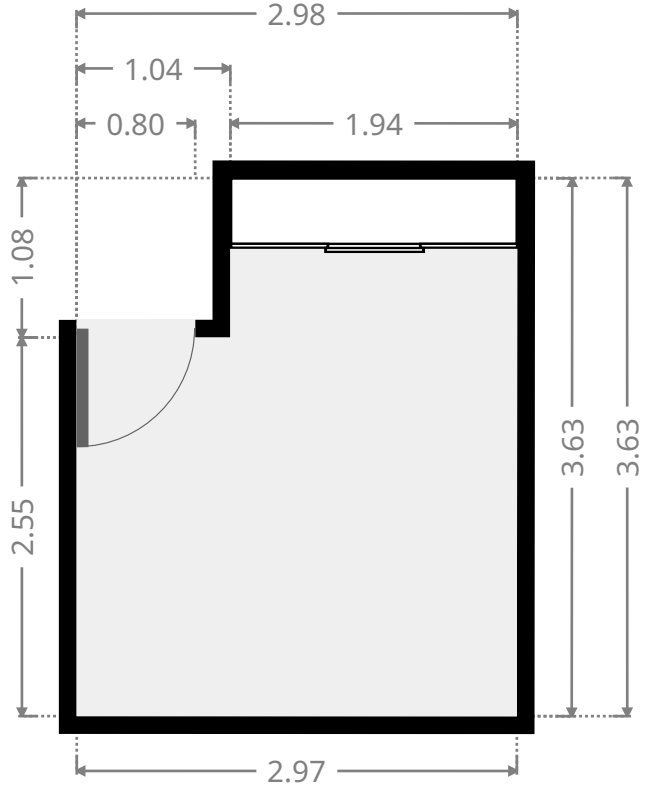
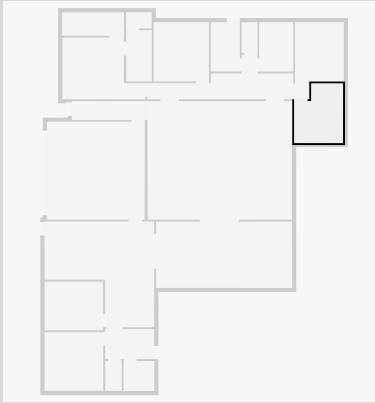

Bedroom

Width: 2.98 m
 Length: 3.62 m
 Area: 10.79 m²
 Perimeter: 13.20 m

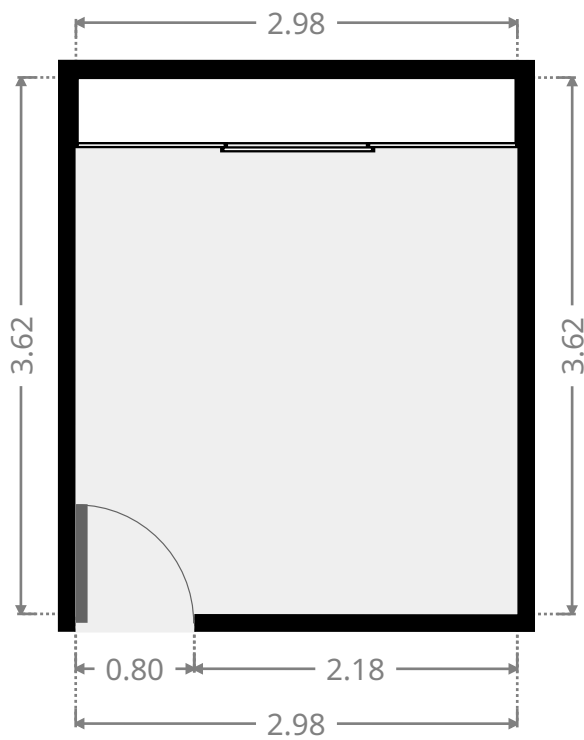
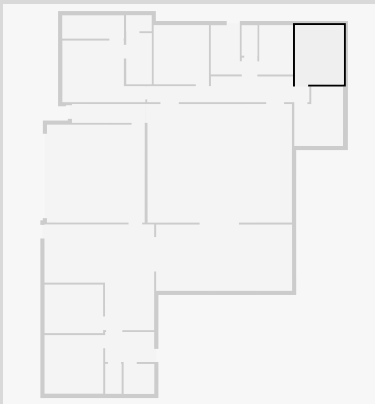

5 Maclyn Avenue

Bathroom

Width: 2.08 m
Length: 3.01 m
Area: 6.26 m²
Perimeter: 10.18 m

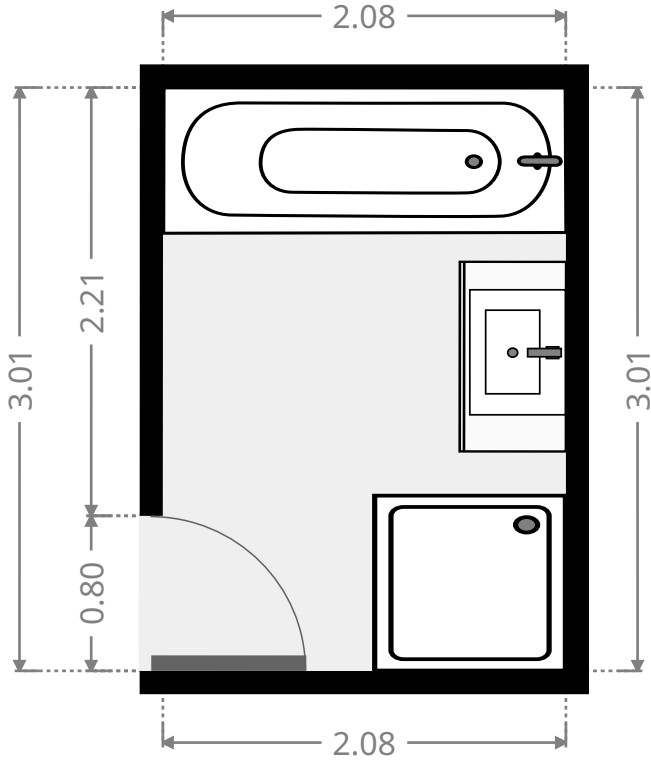

Toilet / Half Bath

Width: 0.97 m
Length: 1.86 m
Area: 1.80 m²
Perimeter: 5.66 m

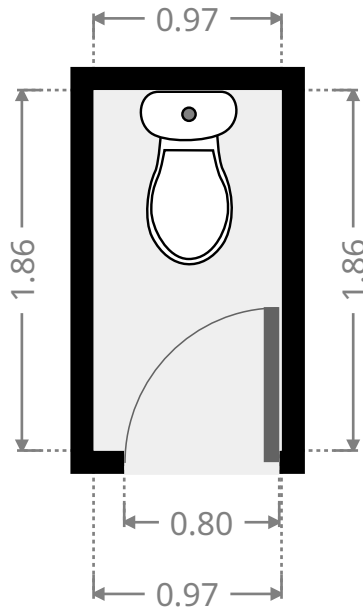

5 Maclyn Avenue

Laundry Room

Width: 1.77 m
Length: 3.00 m
Area: 5.31 m²
Perimeter: 9.54 m

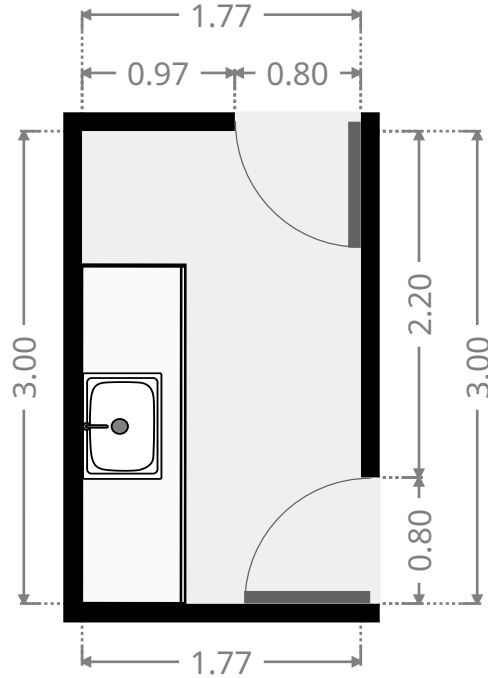
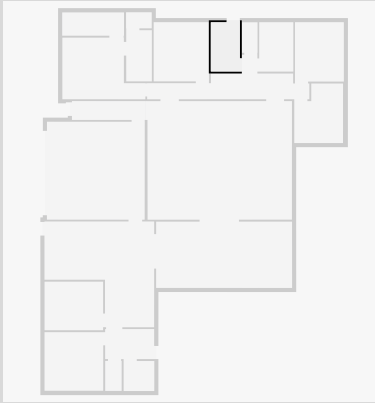

Bedroom

Width: 3.37 m
Length: 3.61 m
Area: 12.16 m²
Perimeter: 13.96 m

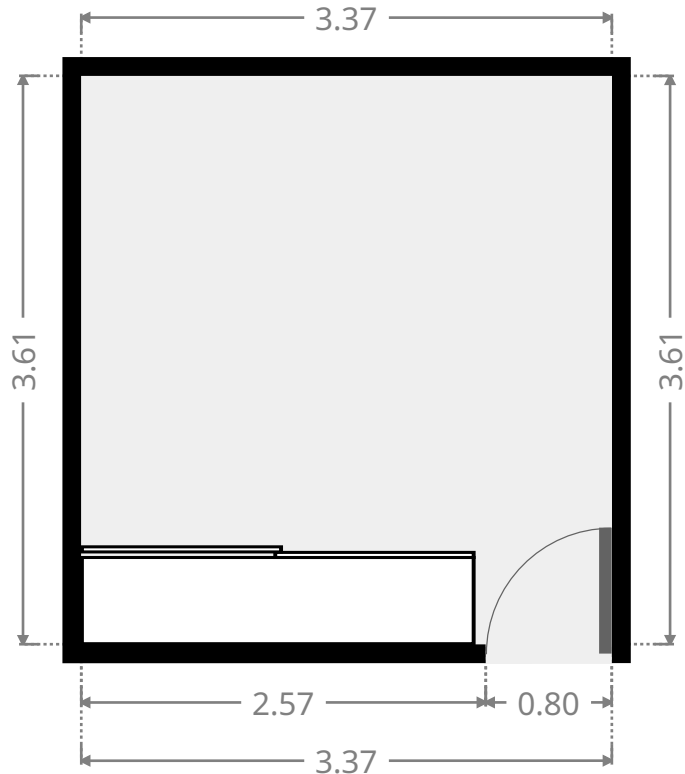
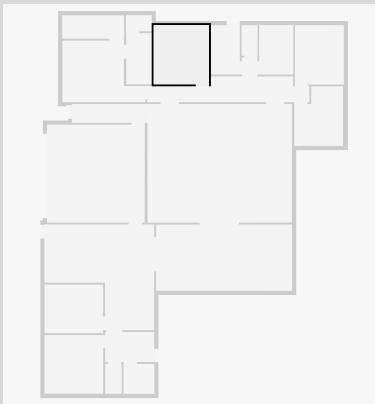

5 Maclyn Avenue

Toilet / Half Bath

Width: 0.98 m
Length: 1.56 m
Area: 1.53 m²
Perimeter: 5.09 m

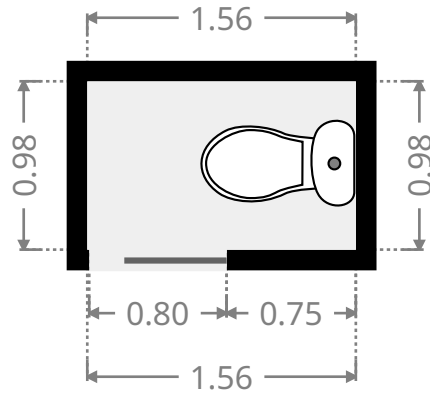

Bathroom

Width: 1.56 m
Length: 3.12 m
Area: 4.87 m²
Perimeter: 9.36 m

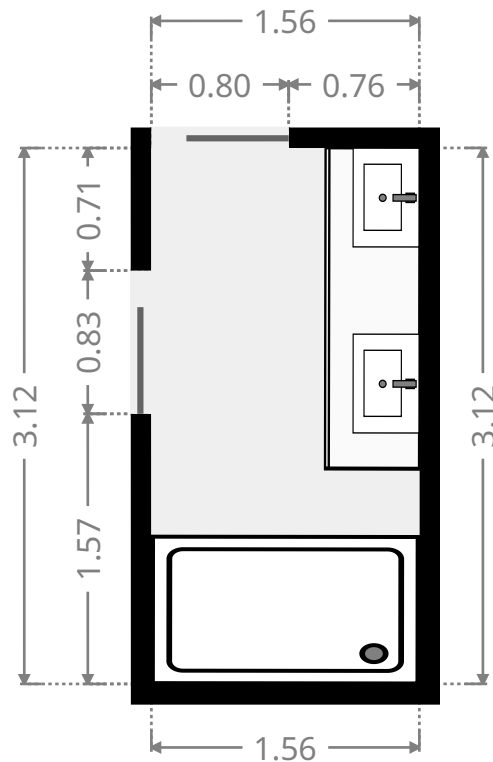
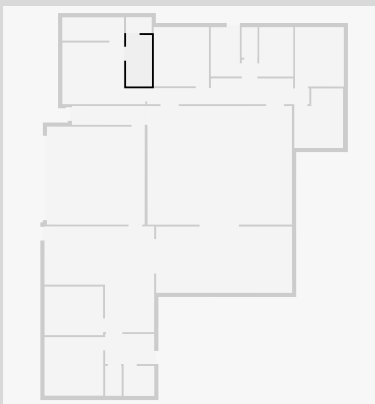

5 Maclyn Avenue

WIR

Width: 1.42 m
 Length: 3.77 m
 Area: 5.35 m²
 Perimeter: 10.38 m

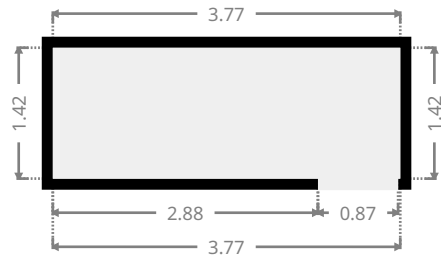

Living/Kitchen/Dining

Width: 6.45 m
 Length: 6.69 m
 Area: 32.43 m²
 Perimeter: 26.28 m

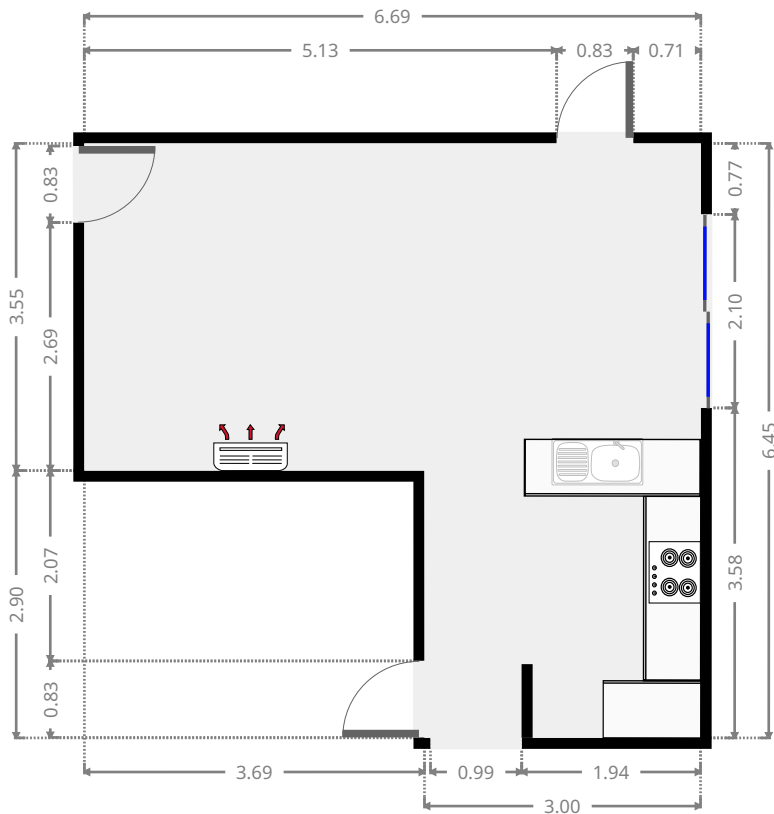

THIS FLOORPLAN IS PROVIDED WITHOUT WARRANTY OF ANY KIND. SENSOPIA DISCLAIMS ANY WARRANTY INCLUDING, WITHOUT LIMITATION, SATISFACTORY QUALITY OR ACCURACY OF DIMENSIONS.

5 Maclyn Avenue

Hall

Width: 2.71 m
 Length: 9.89 m
 Area: 13.71 m²
 Perimeter: 25.21 m

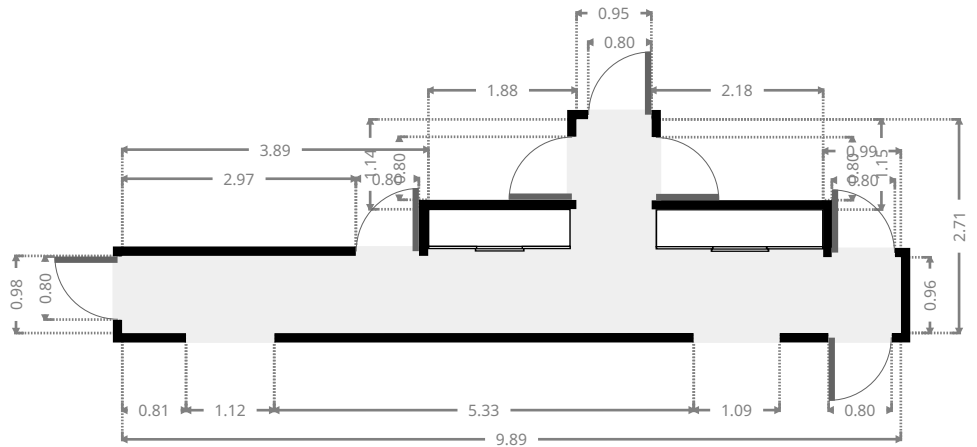
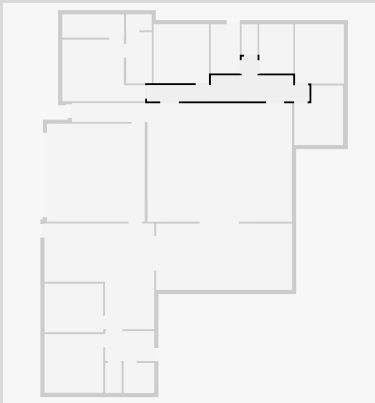

Kitchen/Living/Dining

Width: 7.23 m
 Length: 8.81 m
 Area: 63.66 m²
 Perimeter: 32.07 m

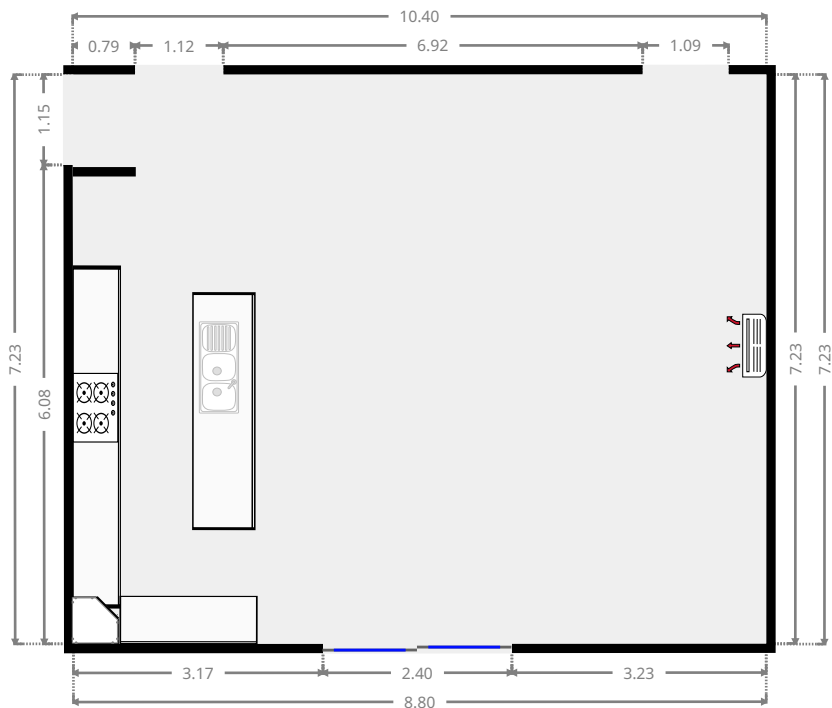
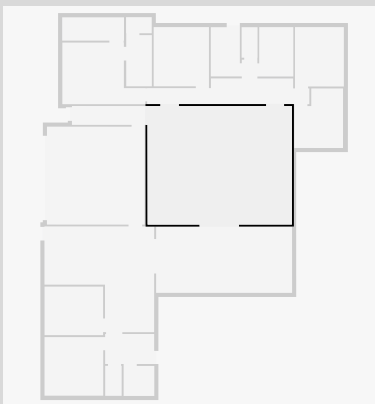

THIS FLOORPLAN IS PROVIDED WITHOUT WARRANTY OF ANY KIND. SENSOPIA DISCLAIMS ANY WARRANTY INCLUDING, WITHOUT LIMITATION, SATISFACTORY QUALITY OR ACCURACY OF DIMENSIONS.

5 Maclyn Avenue

Hall

Width: 1.15 m
Length: 4.47 m
Area: 5.14 m²
Perimeter: 11.24 m

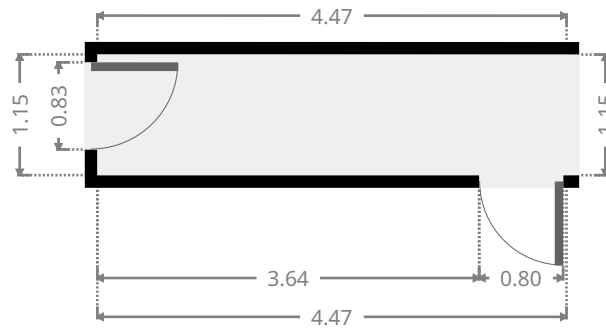

Garage

Width: 5.96 m
Length: 5.97 m
Area: 35.59 m²
Perimeter: 23.86 m

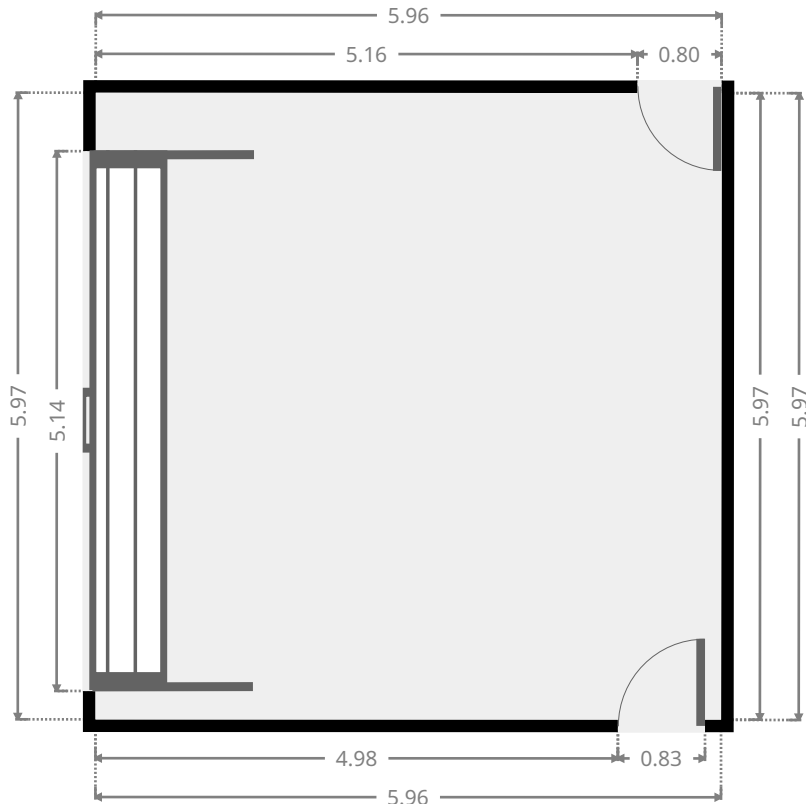
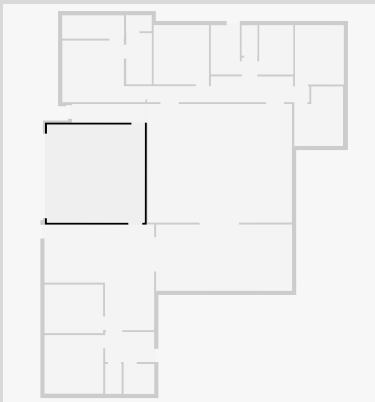

THIS FLOORPLAN IS PROVIDED WITHOUT WARRANTY OF ANY KIND. SENSOPIA DISCLAIMS ANY WARRANTY INCLUDING, WITHOUT LIMITATION, SATISFACTORY QUALITY OR ACCURACY OF DIMENSIONS.

5 Maclyn Avenue

Toilet / Half Bath

Width: 1.00 m
Length: 1.83 m
Area: 1.84 m²
Perimeter: 5.67 m

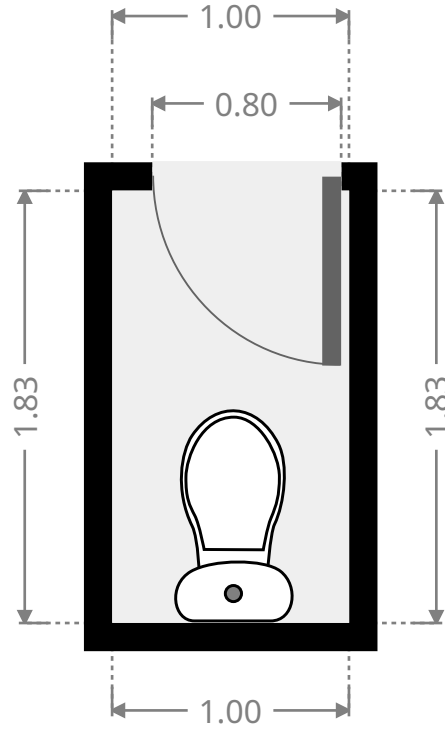
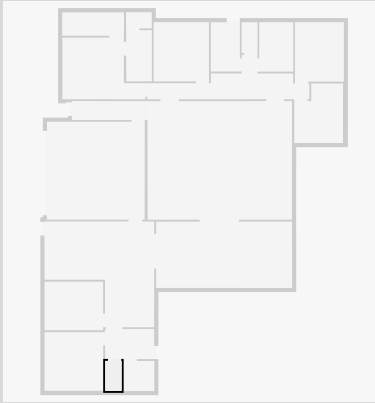

Bathroom

Width: 1.83 m
Length: 1.87 m
Area: 3.42 m²
Perimeter: 7.40 m

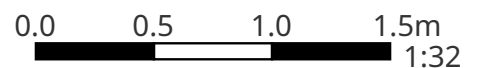
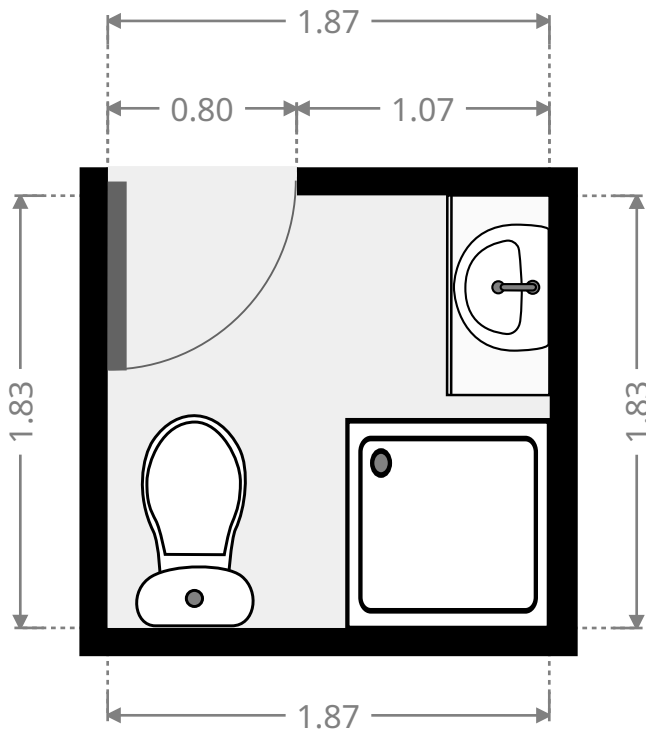

THIS FLOORPLAN IS PROVIDED WITHOUT WARRANTY OF ANY KIND. SENSOPIA DISCLAIMS ANY WARRANTY INCLUDING, WITHOUT LIMITATION, SATISFACTORY QUALITY OR ACCURACY OF DIMENSIONS.

5 Maclyn Avenue

Master Bedroom

Width: 3.57 m
 Length: 3.58 m
 Area: 12.78 m²
 Perimeter: 14.30 m

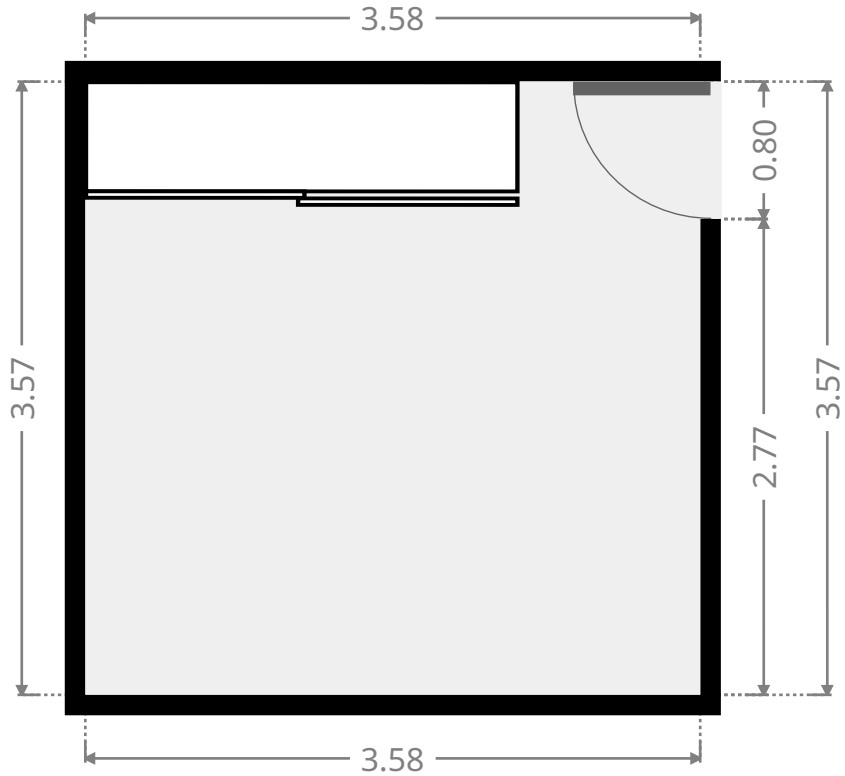

Bedroom

Width: 2.96 m
 Length: 3.57 m
 Area: 10.57 m²
 Perimeter: 13.06 m

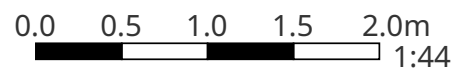
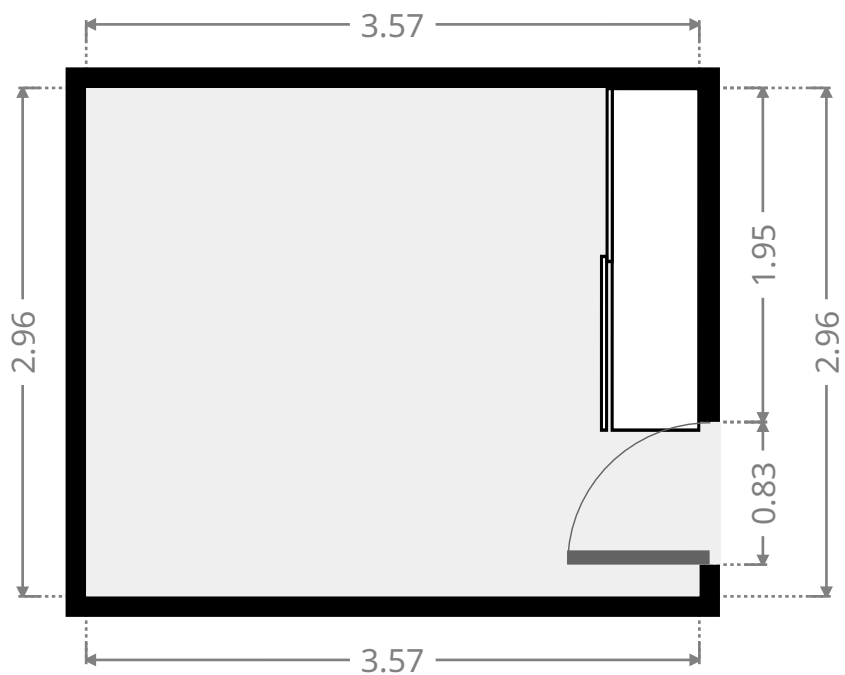

5 Maclyn Avenue

Hall

Width: 1.83 m
Length: 2.99 m
Area: 5.47 m²
Perimeter: 9.64 m

