

5 Lorikeet Court

Created on
2021-01-19

Floors
1

▼ Ground Floor



▼ Living Room
Ground Floor

WIDTH:7.08 m · LENGTH:9.33 m
AREA:44.92 m² · PERIMETER:32.29 m

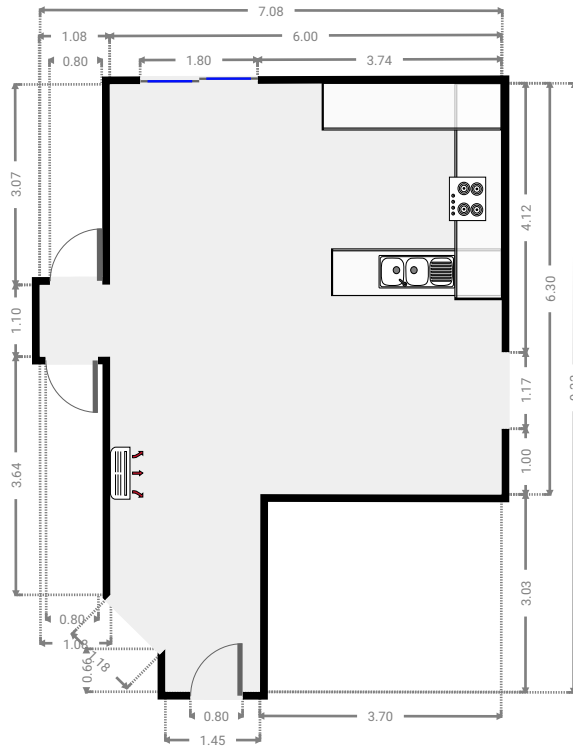
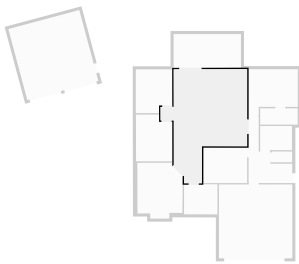

▼ Living Room
Ground Floor

WIDTH:3.71 m · LENGTH:4.56 m
AREA:15.30 m² · PERIMETER:16.00 m

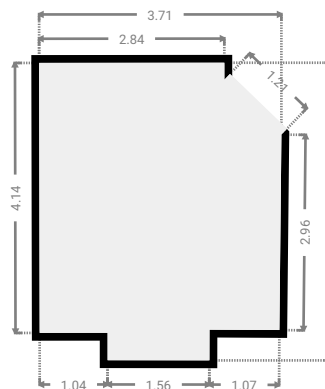
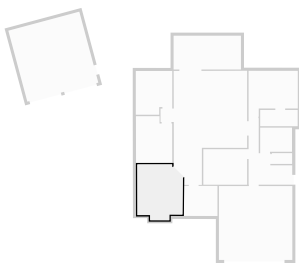

FLOORS:1

▼ Bedroom
Ground Floor

WIDTH:2.96 m · LENGTH:3.82 m
AREA:10.69 m² · PERIMETER:13.56 m

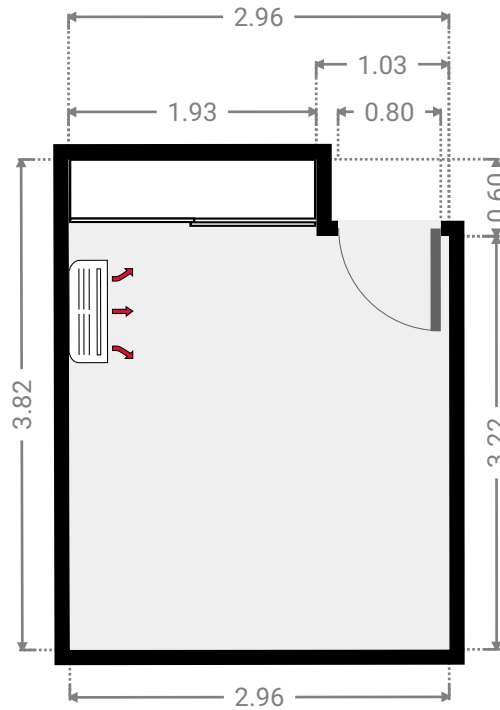
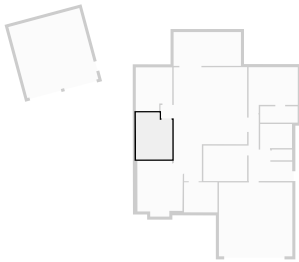

▼ Bedroom
Ground Floor

WIDTH:2.98 m · LENGTH:3.57 m
AREA:9.96 m² · PERIMETER:13.09 m

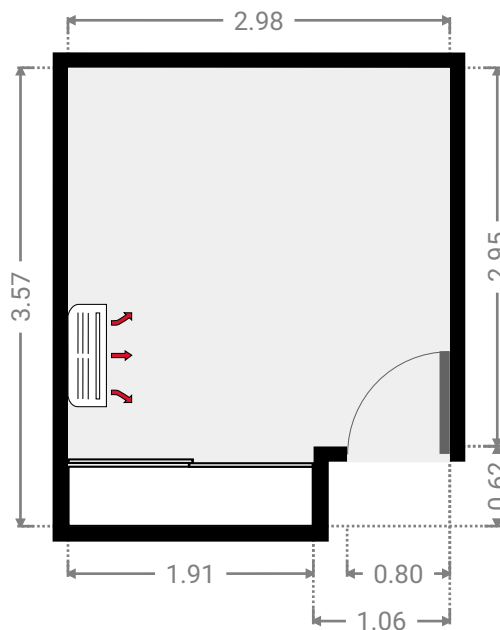
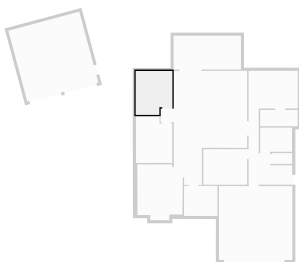

FLOORS:1

▼ Hall
Ground Floor

WIDTH:3.56 m · LENGTH:5.44 m
AREA:9.76 m² · PERIMETER:18.01 m

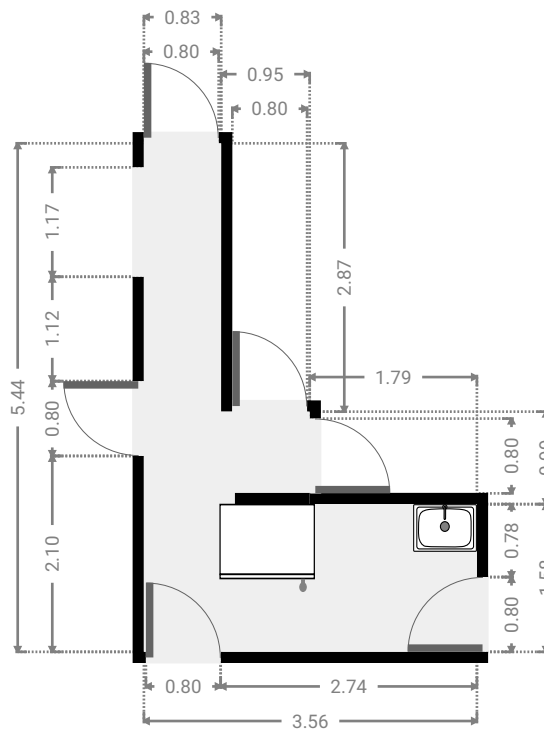
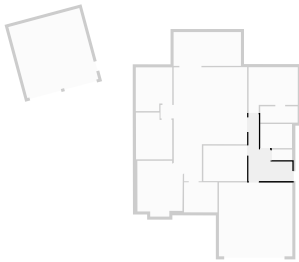

▼ Bedroom
Ground Floor

WIDTH:3.58 m · LENGTH:2.90 m
AREA:10.38 m² · PERIMETER:12.96 m

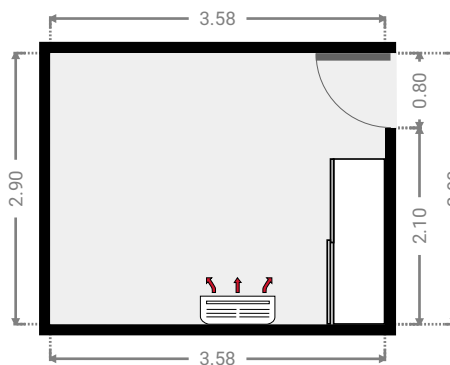
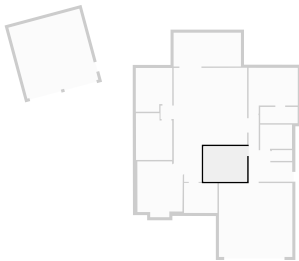

FLOORS:1

▼ **Toilet**
Ground Floor

WIDTH:1.66 m · LENGTH:0.88 m
AREA:1.46 m² · PERIMETER:5.08 m

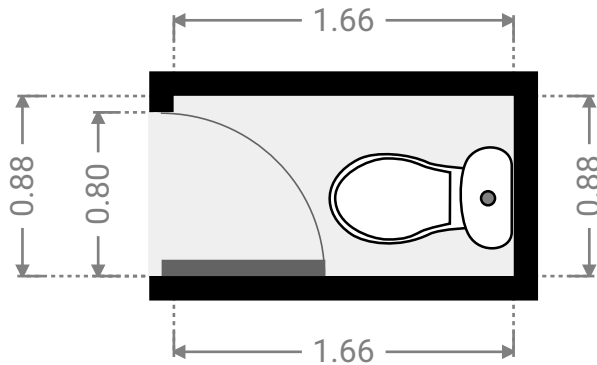
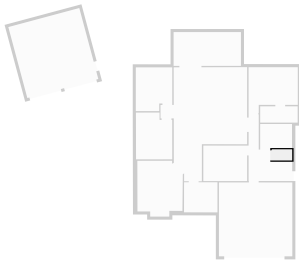

▼ **Bathroom**
Ground Floor

WIDTH:2.60 m · LENGTH:1.97 m
AREA:5.12 m² · PERIMETER:9.14 m

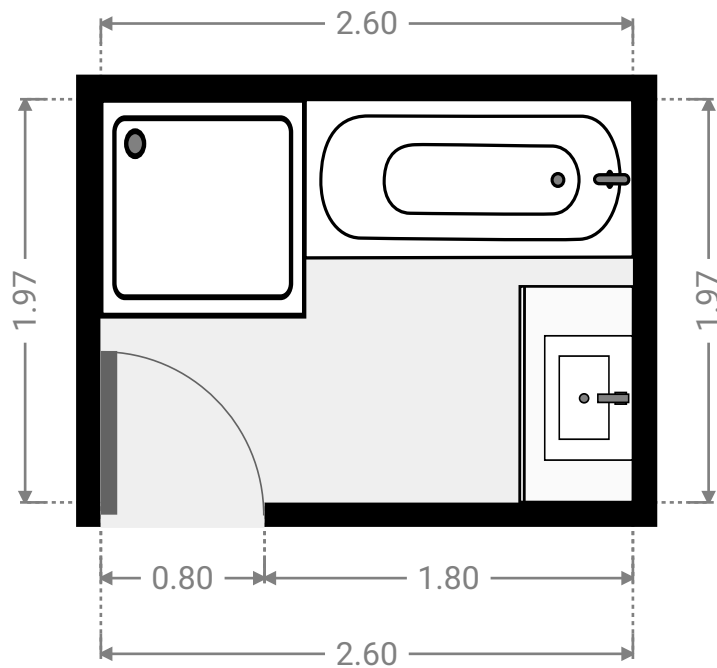
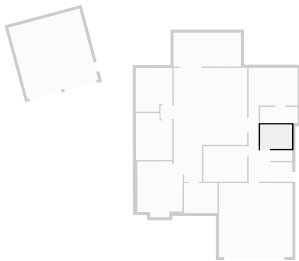

▼ Bathroom Ground Floor

WIDTH:3.06 m · LENGTH:1.33 m
AREA:4.07 m² · PERIMETER:8.78 m

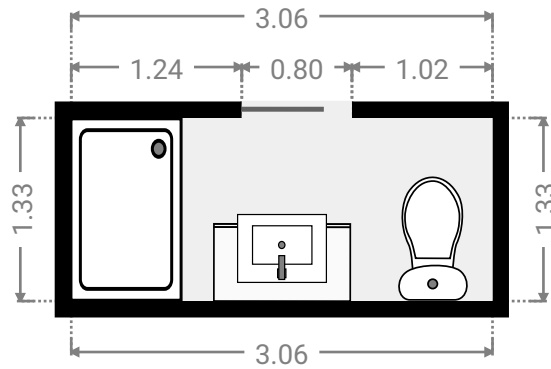
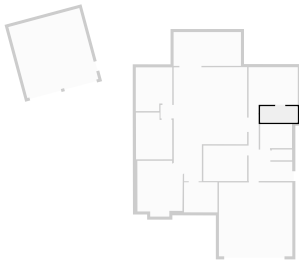

▼ Master Bedroom Ground Floor

WIDTH:4.02 m · LENGTH:3.74 m
AREA:12.90 m² · PERIMETER:15.51 m

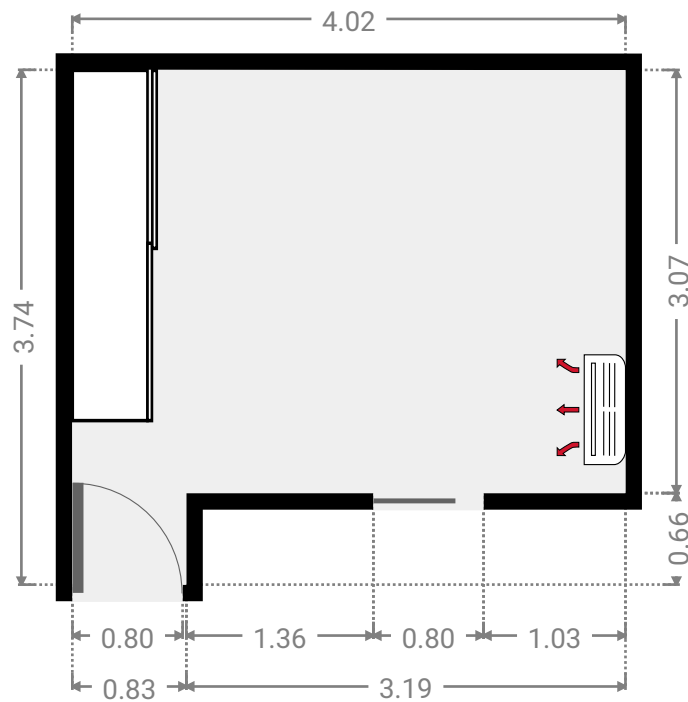
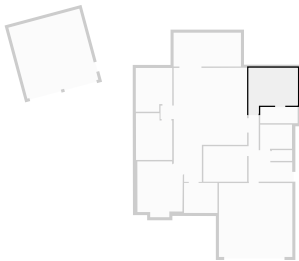

FLOORS:1

▼ Other Ground Floor

WIDTH:5.50 m · LENGTH:2.76 m
AREA:15.18 m² · PERIMETER:16.52 m

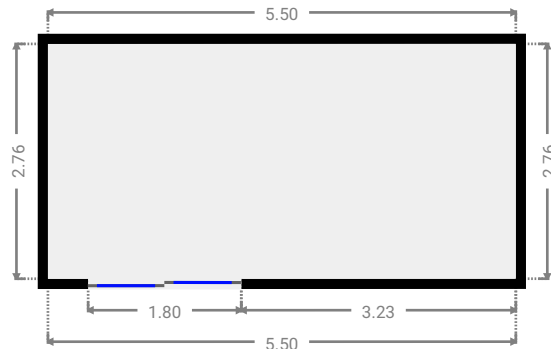
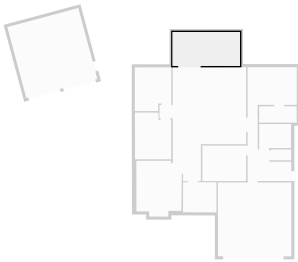

▼ Garage Ground Floor

WIDTH:6.00 m · LENGTH:6.00 m
AREA:36.00 m² · PERIMETER:24.00 m

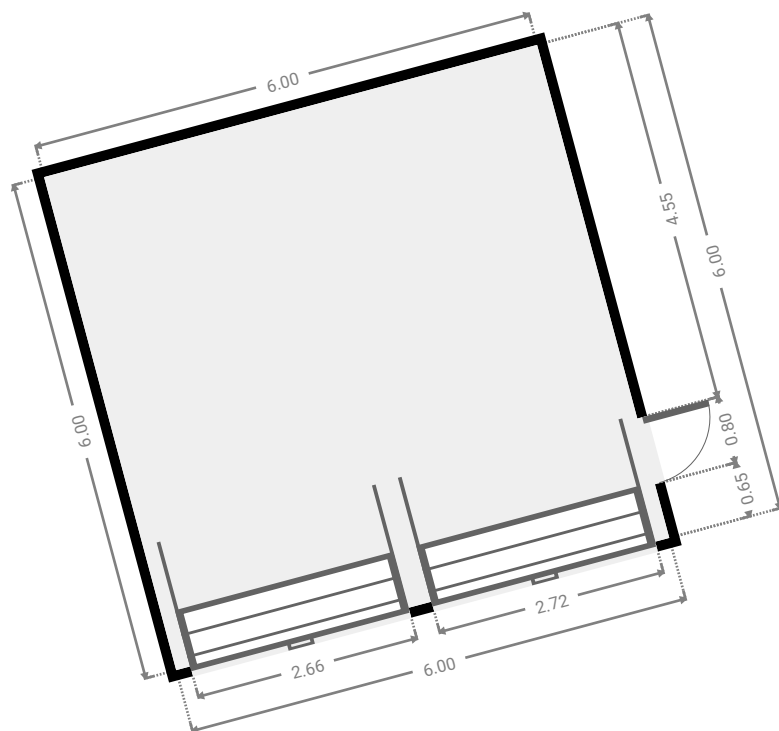
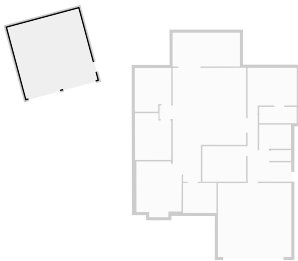

▼ Other Ground Floor

WIDTH:2.73 m · LENGTH:2.46 m
AREA:6.71 m² · PERIMETER:10.37 m

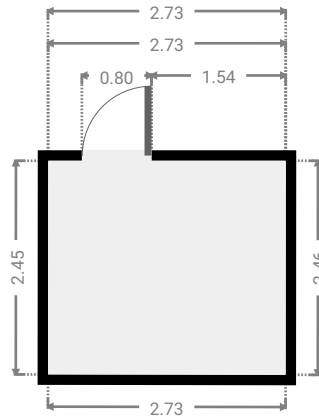
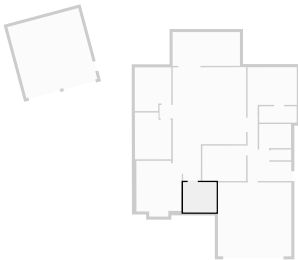

▼ Garage Ground Floor

WIDTH:6.00 m · LENGTH:6.03 m
AREA:36.17 m² · PERIMETER:24.06 m

