

Ground Floor

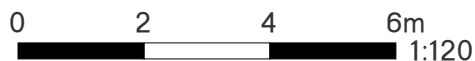

5 League Place

THIS FLOORPLAN IS PROVIDED WITHOUT WARRANTY OF ANY KIND. SENSOPIA DISCLAIMS ANY WARRANTY INCLUDING, WITHOUT LIMITATION, SATISFACTORY QUALITY OR ACCURACY OF DIMENSIONS.

Laundry Room

Width: 1.78 m
 Length: 3.25 m
 Area: 5.18 m²
 Perimeter: 10.03 m

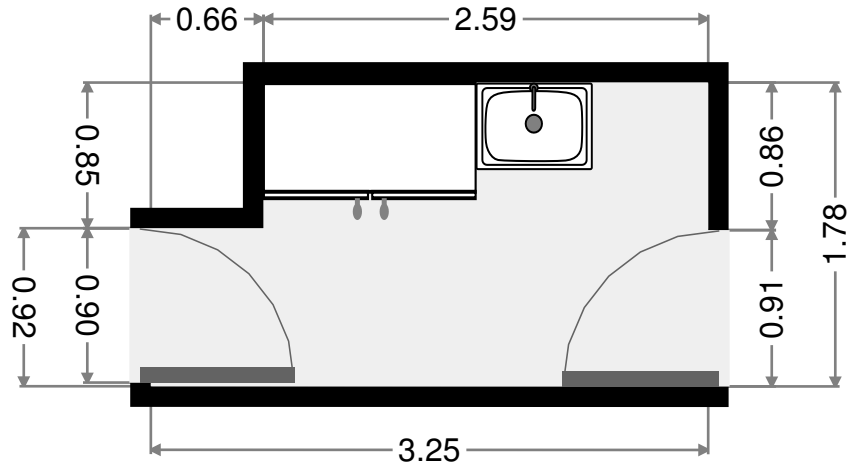
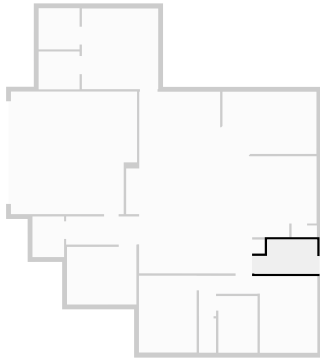

•
 Width: 1.64 m
 Length: 2.10 m
 Area: 3.43 m²
 Perimeter: 7.47 m

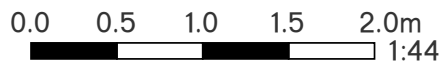
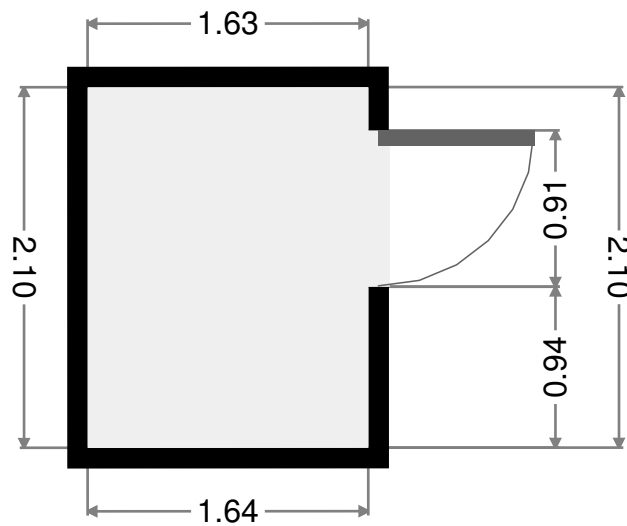
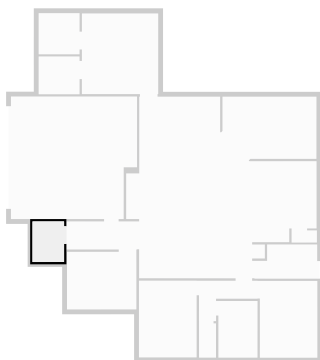

THIS FLOORPLAN IS PROVIDED WITHOUT WARRANTY OF ANY KIND. SENSOPIA DISCLAIMS ANY WARRANTY INCLUDING, WITHOUT LIMITATION, SATISFACTORY QUALITY OR ACCURACY OF DIMENSIONS.

Outdoor Area

Width: 3.21 m
 Length: 4.86 m
 Area: 14.58 m²
 Perimeter: 15.30 m
 Ceiling Height: 2.17 m

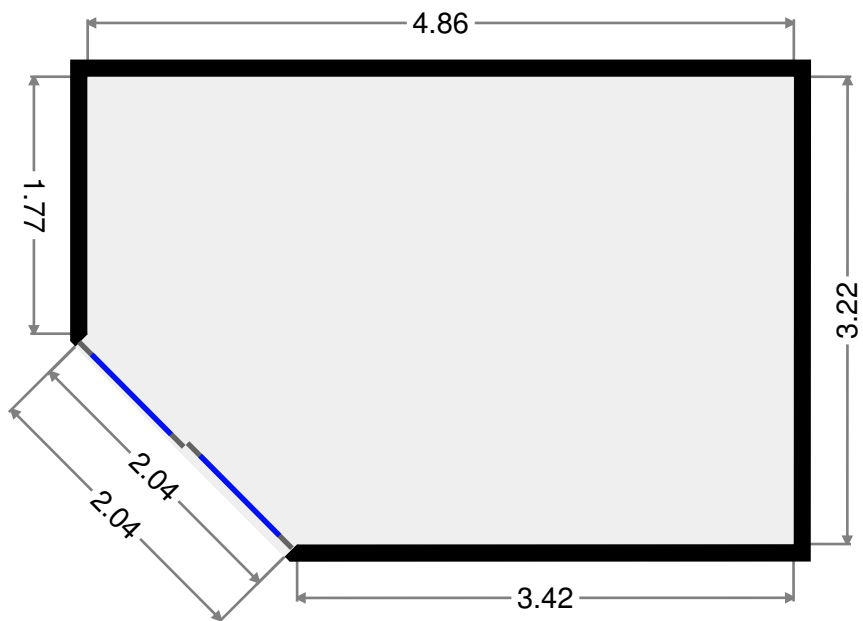
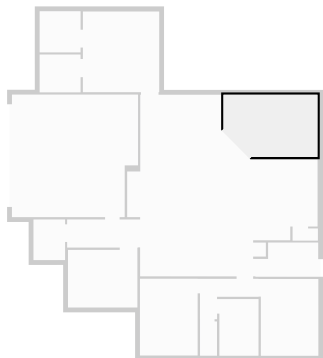

Bathroom

Width: 2.02 m
 Length: 2.93 m
 Area: 5.92 m²
 Perimeter: 9.90 m

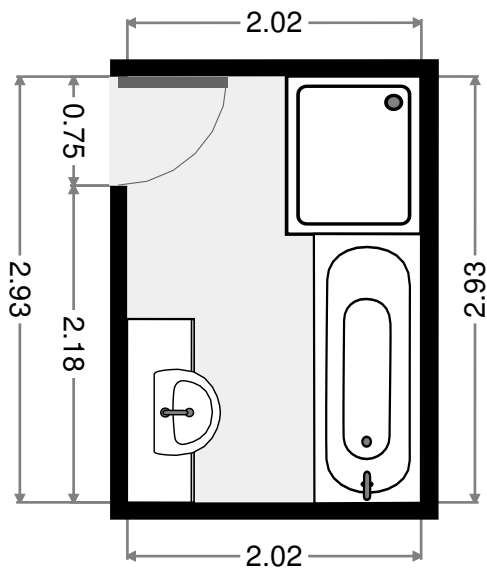
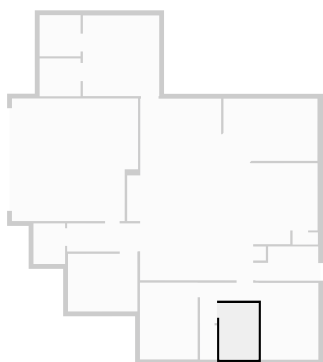

THIS FLOORPLAN IS PROVIDED WITHOUT WARRANTY OF ANY KIND. SENSOPIA DISCLAIMS ANY WARRANTY INCLUDING, WITHOUT LIMITATION, SATISFACTORY QUALITY OR ACCURACY OF DIMENSIONS.

Toilet

Width: 0.88 m
Length: 1.77 m
Area: 1.55 m²
Perimeter: 5.30 m

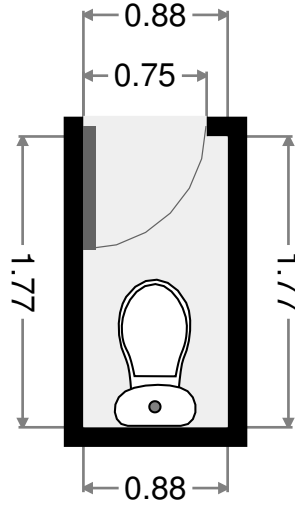
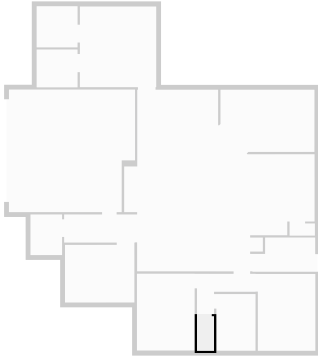

Bedroom

Width: 2.98 m
Length: 3.97 m
Area: 11.85 m²
Perimeter: 13.91 m

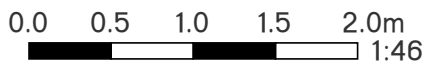
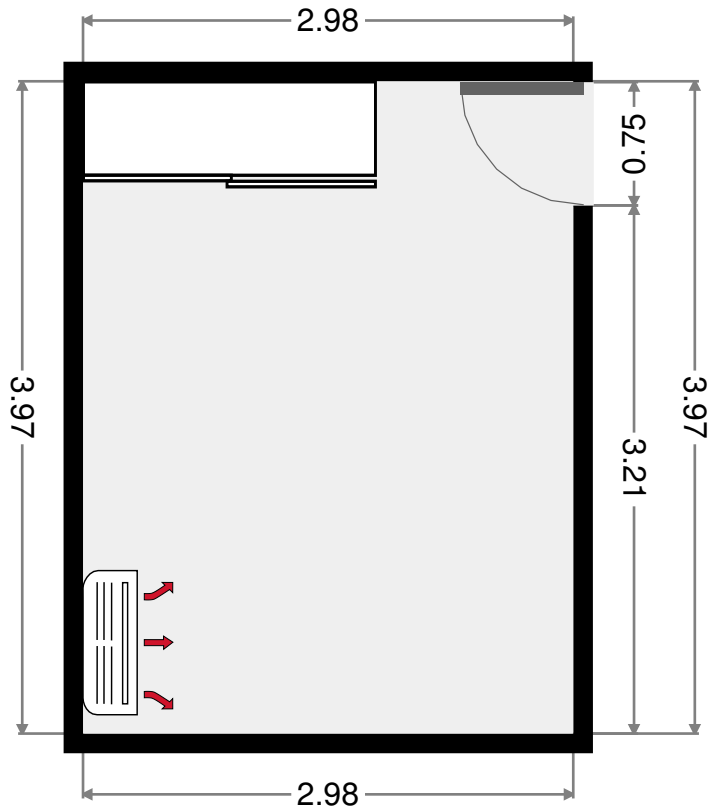
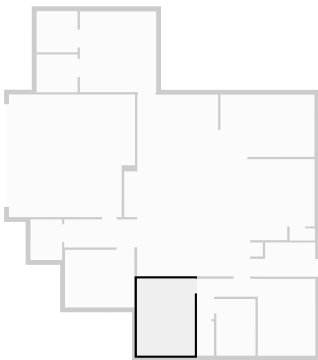

THIS FLOORPLAN IS PROVIDED WITHOUT WARRANTY OF ANY KIND. SENSOPIA DISCLAIMS ANY WARRANTY INCLUDING, WITHOUT LIMITATION, SATISFACTORY QUALITY OR ACCURACY OF DIMENSIONS.

Bedroom

Width: 2.98 m
 Length: 3.97 m
 Area: 11.81 m²
 Perimeter: 13.89 m

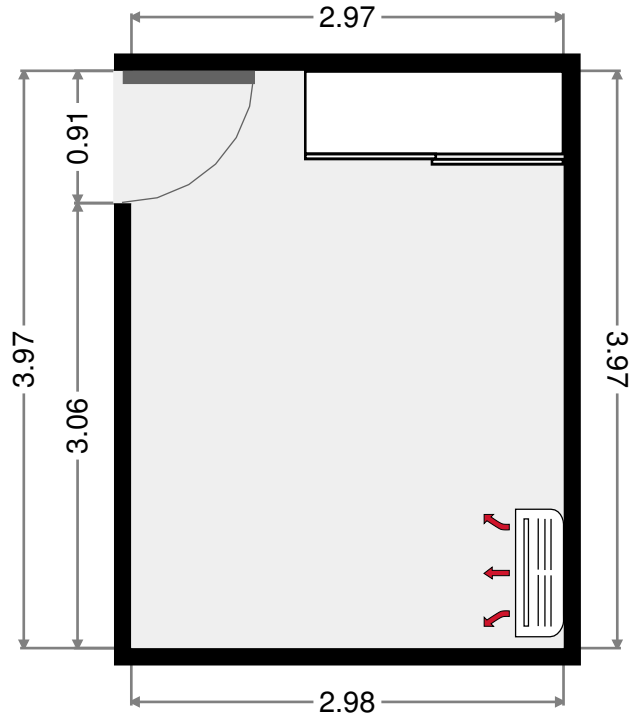
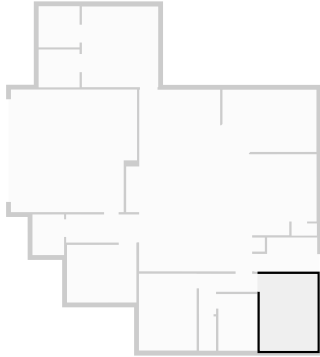

Hall

Width: 2.09 m
 Length: 3.03 m
 Area: 3.83 m²
 Perimeter: 10.24 m

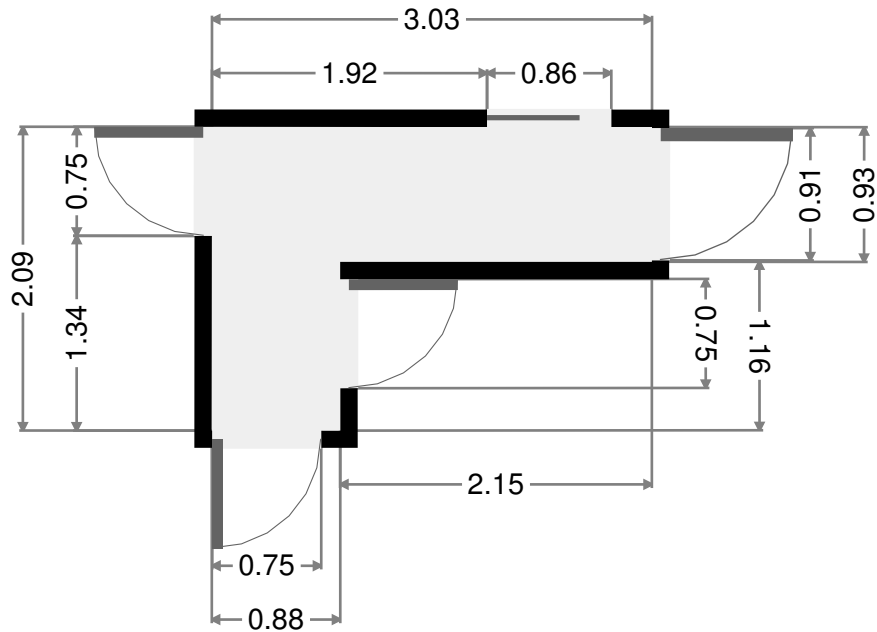
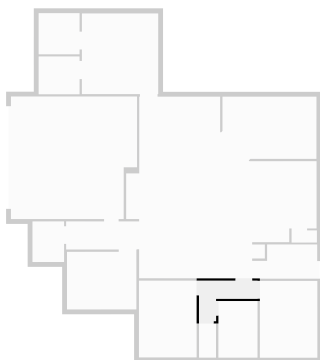

THIS FLOORPLAN IS PROVIDED WITHOUT WARRANTY OF ANY KIND. SENSOPIA DISCLAIMS ANY WARRANTY INCLUDING, WITHOUT LIMITATION, SATISFACTORY QUALITY OR ACCURACY OF DIMENSIONS.

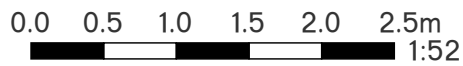

Closet

Width: 0.53 m
 Length: 0.72 m
 Area: 0.39 m²
 Perimeter: 2.51 m

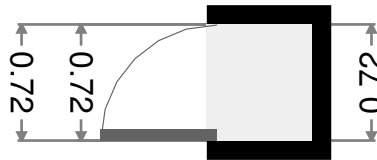
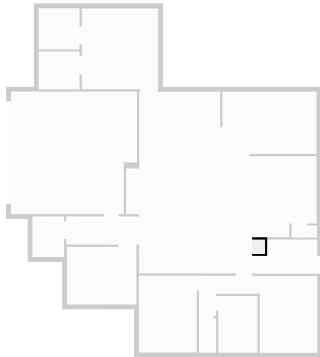

Entry

Width: 1.46 m
 Length: 3.68 m
 Area: 5.33 m²
 Perimeter: 10.24 m

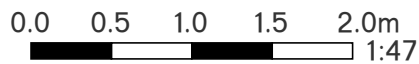
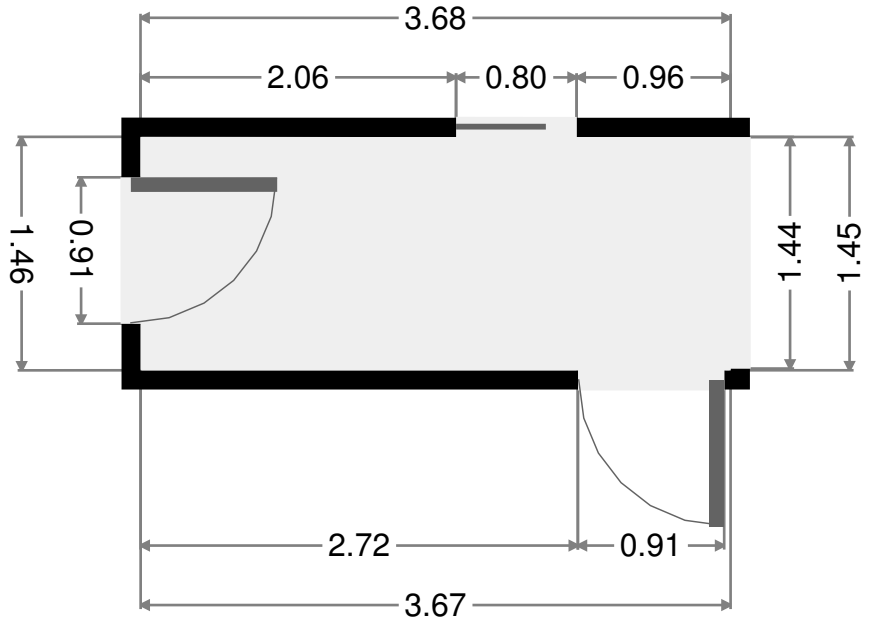
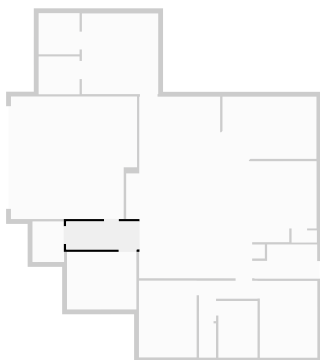

THIS FLOORPLAN IS PROVIDED WITHOUT WARRANTY OF ANY KIND. SENSOPIA DISCLAIMS ANY WARRANTY INCLUDING, WITHOUT LIMITATION, SATISFACTORY QUALITY OR ACCURACY OF DIMENSIONS.

Ensuite

Width: 2.12 m
 Length: 2.13 m
 Area: 4.50 m²
 Perimeter: 8.49 m

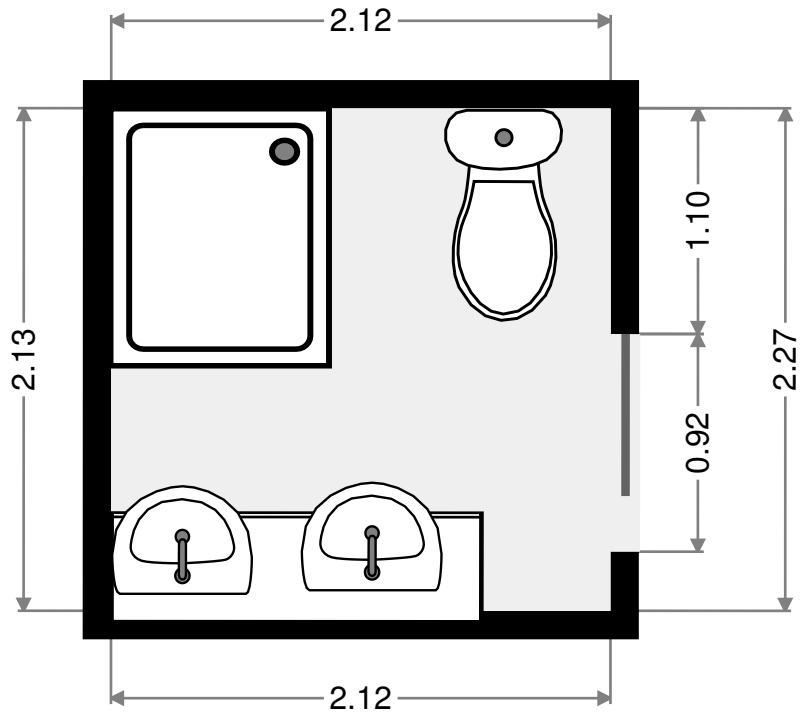
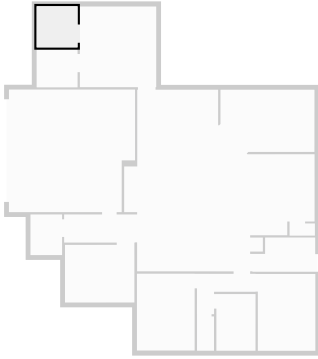

Closet

Width: 1.96 m
 Length: 2.12 m
 Area: 4.14 m²
 Perimeter: 8.14 m

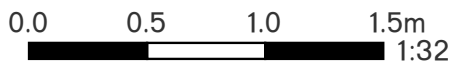
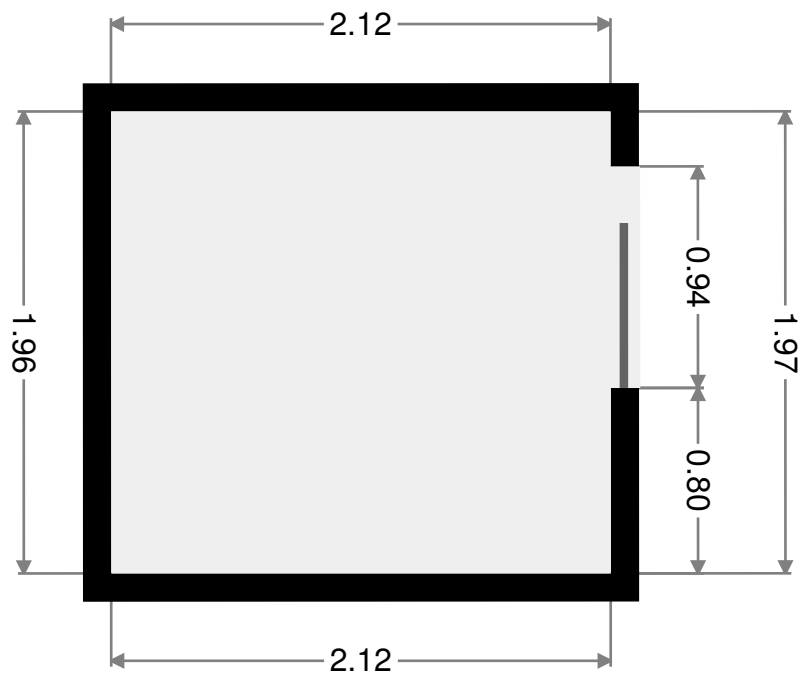
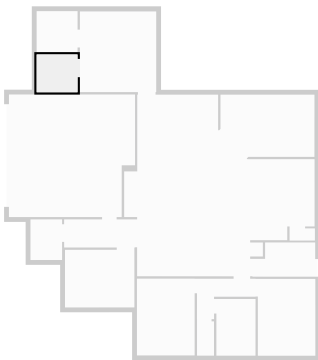

THIS FLOORPLAN IS PROVIDED WITHOUT WARRANTY OF ANY KIND. SENSOPIA DISCLAIMS ANY WARRANTY INCLUDING, WITHOUT LIMITATION, SATISFACTORY QUALITY OR ACCURACY OF DIMENSIONS.

Master Bedroom

Width: 3.95 m
 Length: 4.17 m
 Area: 16.46 m²
 Perimeter: 16.23 m

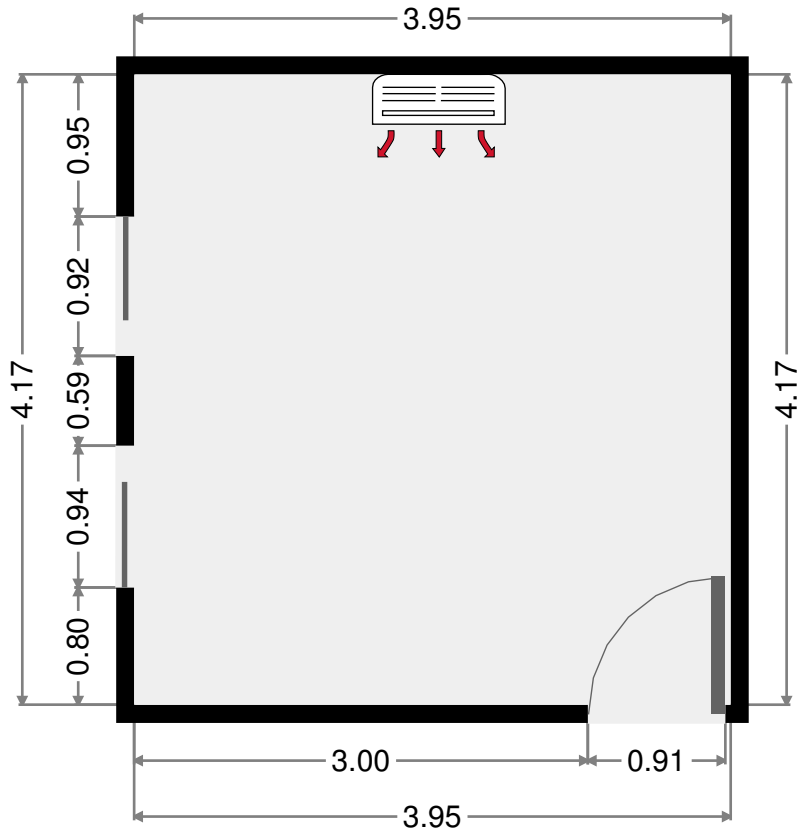
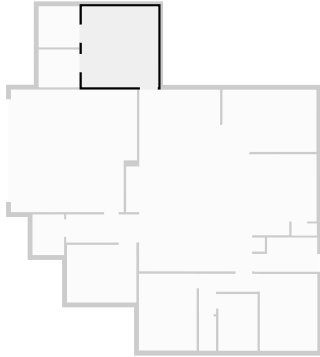

Pantry

Width: 0.63 m
 Length: 1.31 m
 Area: 0.82 m²
 Perimeter: 3.87 m

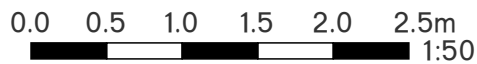
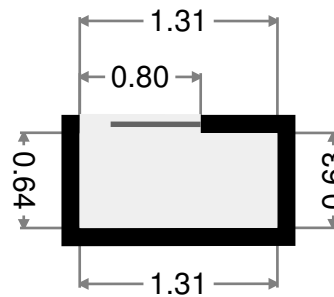
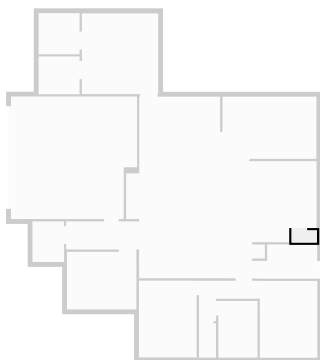

THIS FLOORPLAN IS PROVIDED WITHOUT WARRANTY OF ANY KIND. SENSOPIA DISCLAIMS ANY WARRANTY INCLUDING, WITHOUT LIMITATION, SATISFACTORY QUALITY OR ACCURACY OF DIMENSIONS.

Living Room

Width: 9.37 m
 Length: 9.84 m
 Area: 65.00 m²
 Perimeter: 37.58 m
 Ceiling Height: 2.17 m

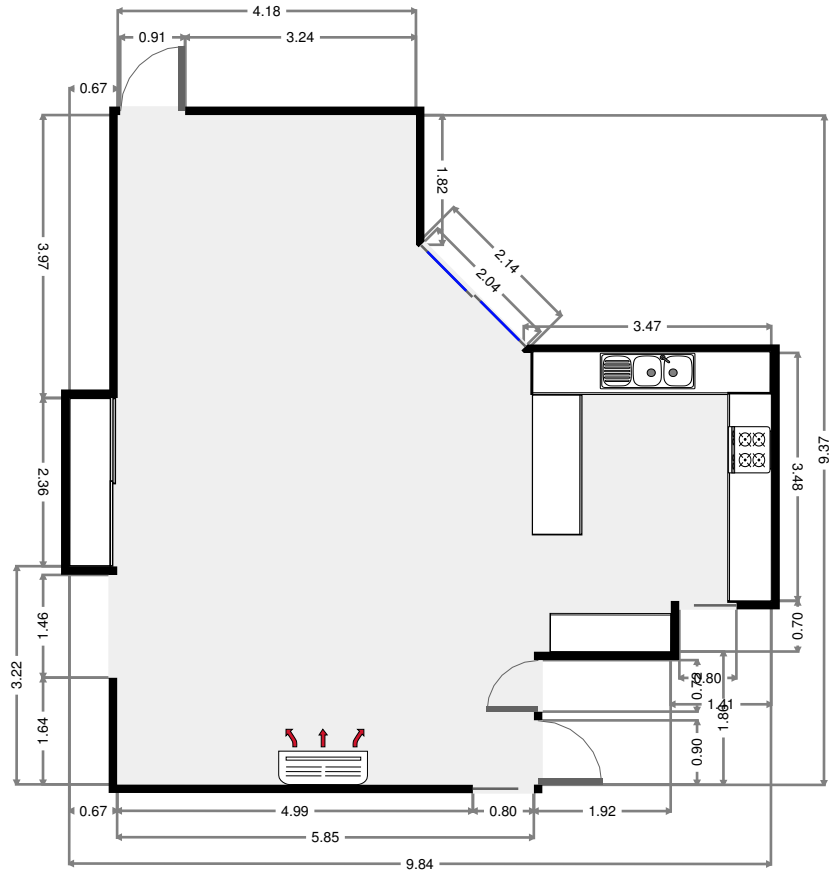
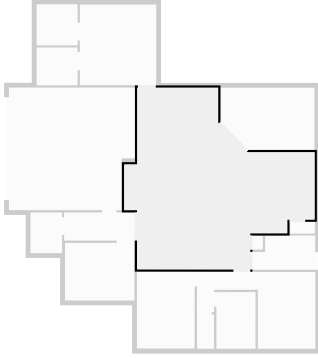

Garage

Width: 6.34 m
 Length: 6.52 m
 Area: 39.46 m²
 Perimeter: 25.71 m

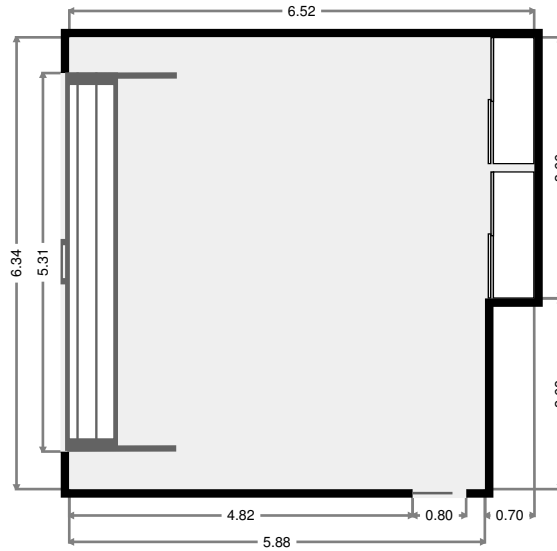
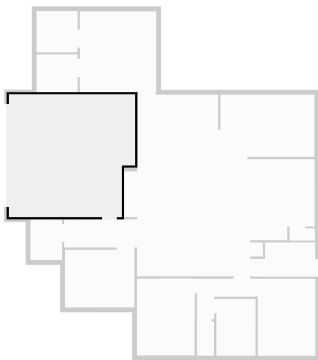

THIS FLOORPLAN IS PROVIDED WITHOUT WARRANTY OF ANY KIND. SENSOPIA DISCLAIMS ANY WARRANTY INCLUDING, WITHOUT LIMITATION, SATISFACTORY QUALITY OR ACCURACY OF DIMENSIONS.

Bedroom

Width: 2.98 m
Length: 3.58 m
Area: 10.69 m²
Perimeter: 13.13 m

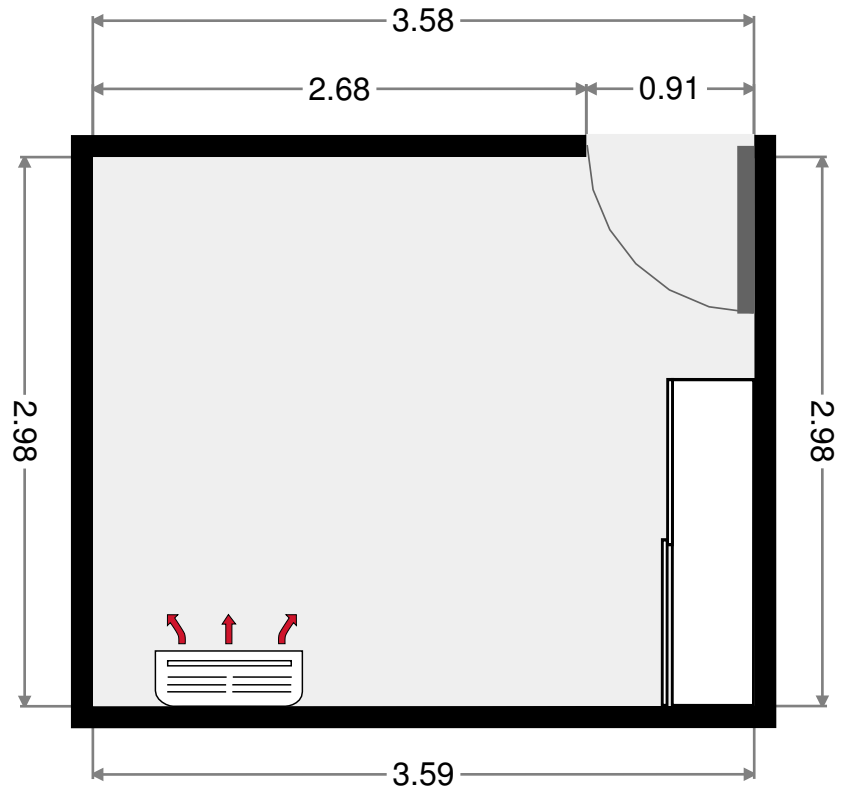
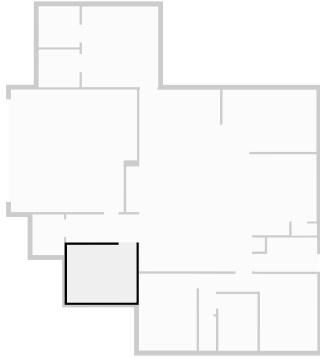

THIS FLOORPLAN IS PROVIDED WITHOUT WARRANTY OF ANY KIND. SENSOPIA DISCLAIMS ANY WARRANTY INCLUDING, WITHOUT LIMITATION, SATISFACTORY QUALITY OR ACCURACY OF DIMENSIONS.

