

5 Lanham Court

Created on
2021-05-19

Floors
2

▼ Ground Floor

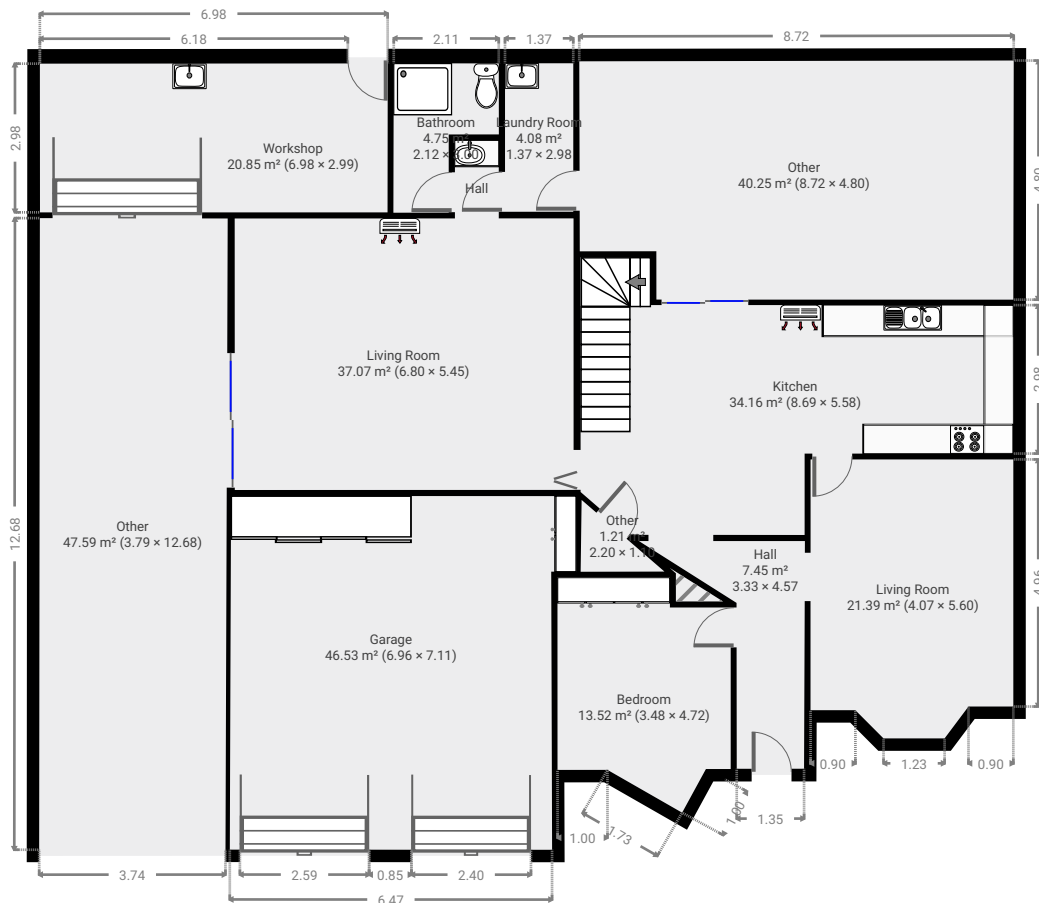
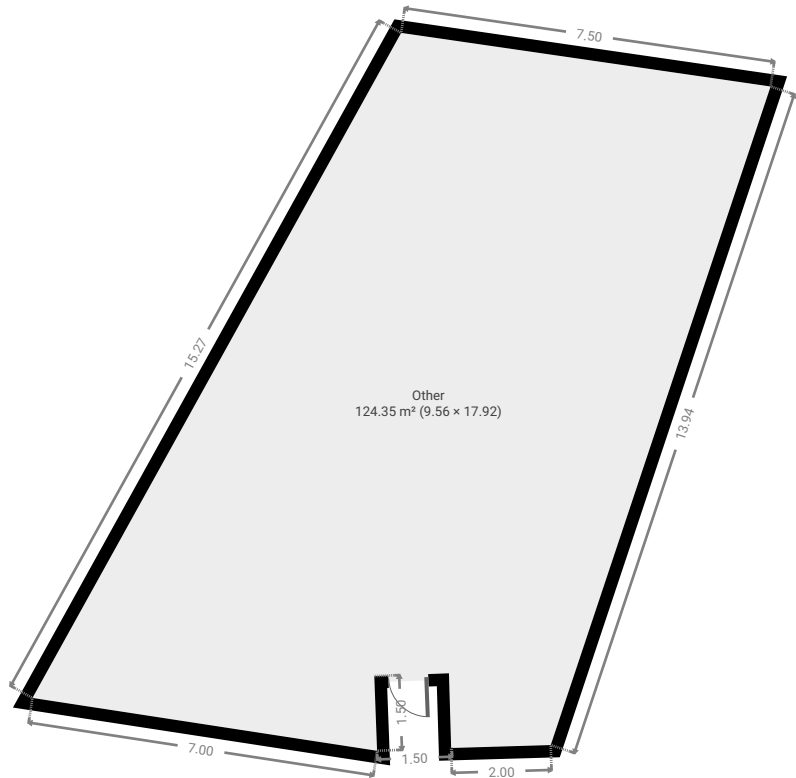

▼ **Hall**
Ground Floor

WIDTH: 3.33 m • LENGTH: 4.57 m
AREA: 7.45 m² • PERIMETER: 14.91 m

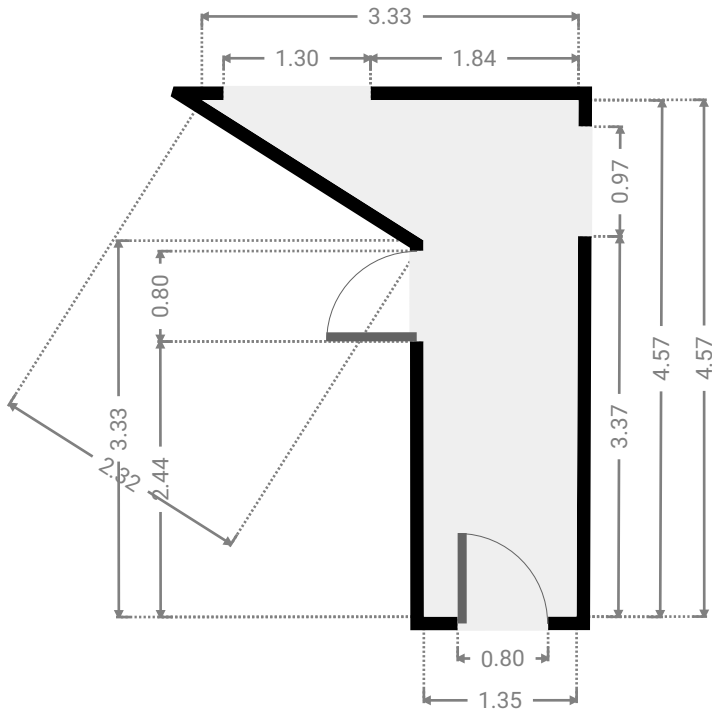
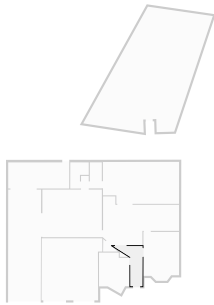

▼ **Bedroom**
Ground Floor

WIDTH: 3.48 m • LENGTH: 4.72 m
AREA: 13.52 m² • PERIMETER: 15.40 m

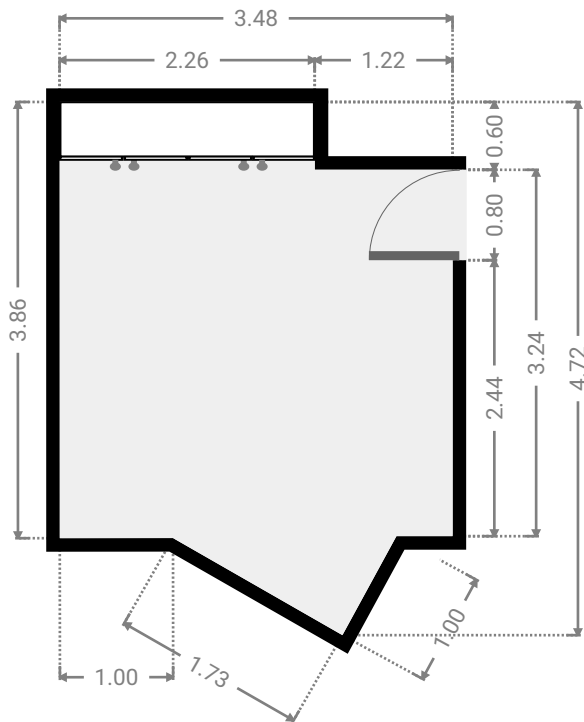
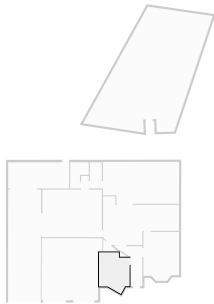

▼ Living Room Ground Floor

WIDTH: 4.07 m • LENGTH: 5.60 m
AREA: 21.39 m² • PERIMETER: 18.69 m

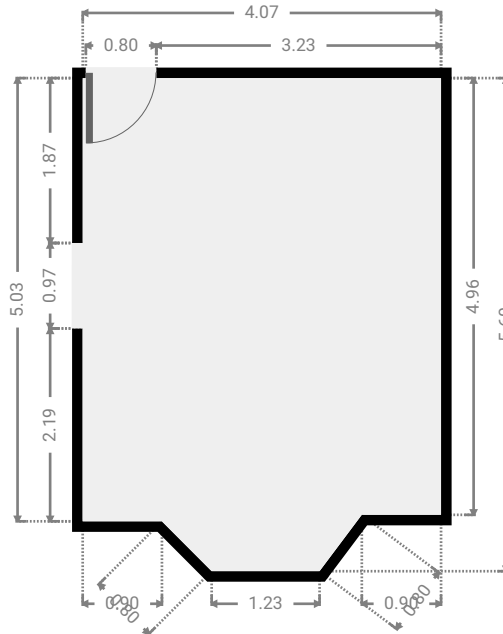
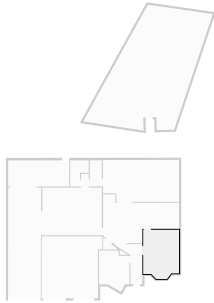

▼ Kitchen Ground Floor

WIDTH: 8.69 m • LENGTH: 5.58 m
AREA: 34.16 m² • PERIMETER: 27.99 m

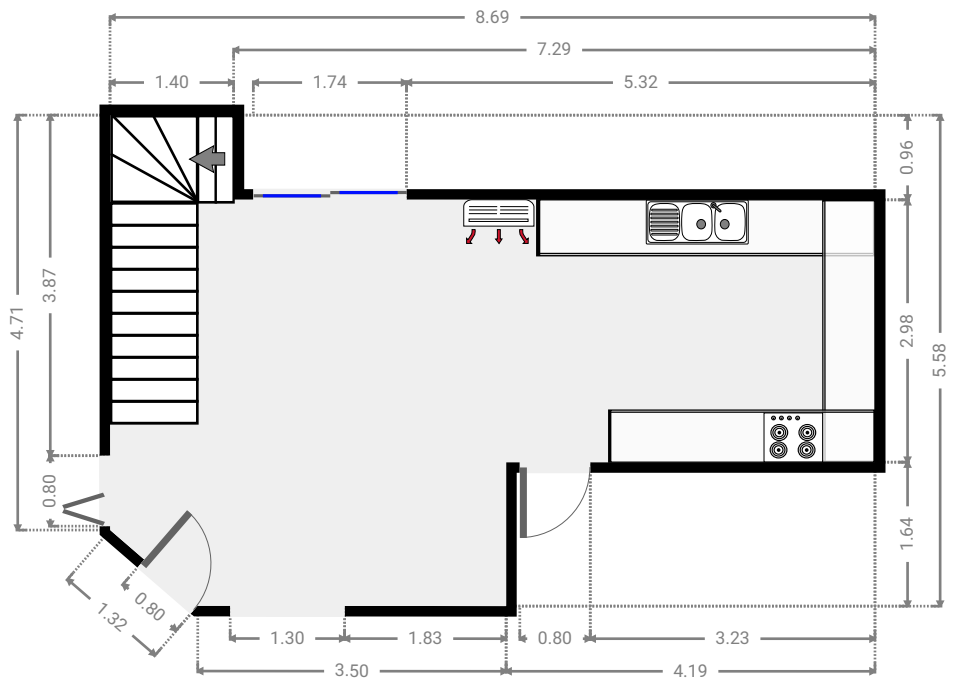
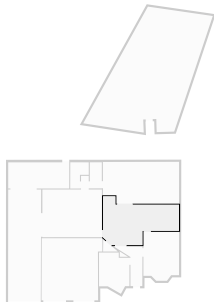

▼ Living Room
Ground Floor

WIDTH: 6.80 m • LENGTH: 5.45 m
AREA: 37.07 m² • PERIMETER: 24.50 m

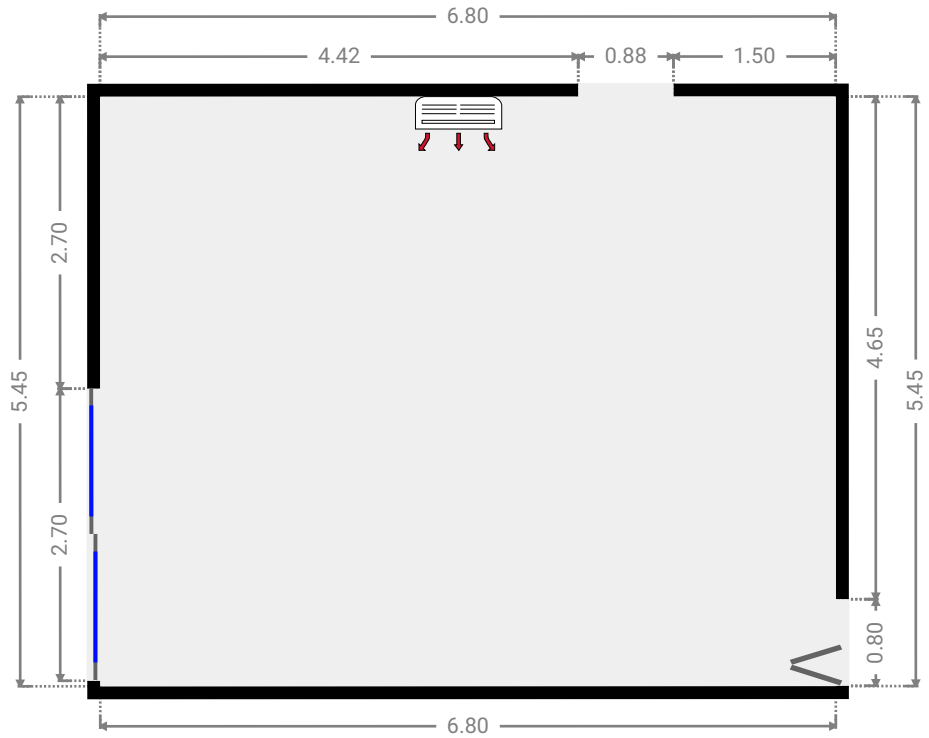
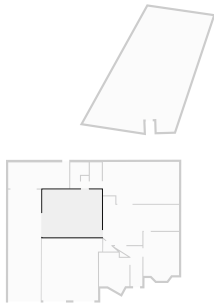

▼ Laundry Room
Ground Floor

WIDTH: 1.37 m • LENGTH: 2.98 m
AREA: 4.08 m² • PERIMETER: 8.70 m

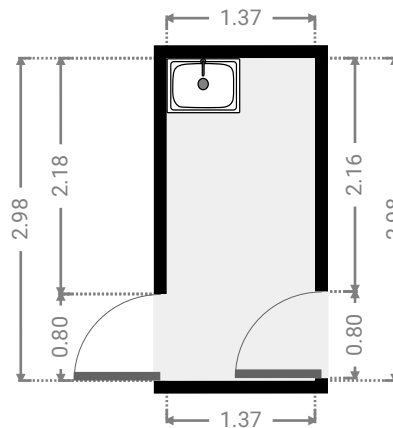
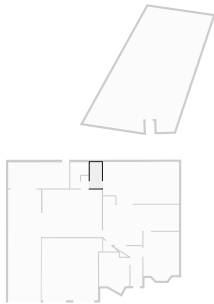

▼ **Hall**
Ground Floor

WIDTH: 0.88 m • LENGTH: 1.44 m
AREA: 1.27 m² • PERIMETER: 4.64 m

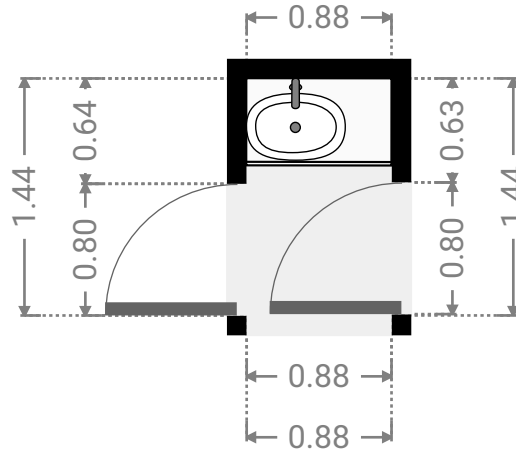
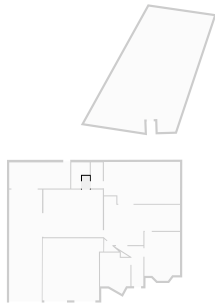

▼ **Bathroom**
Ground Floor

WIDTH: 2.12 m • LENGTH: 3.00 m
AREA: 4.75 m² • PERIMETER: 10.22 m

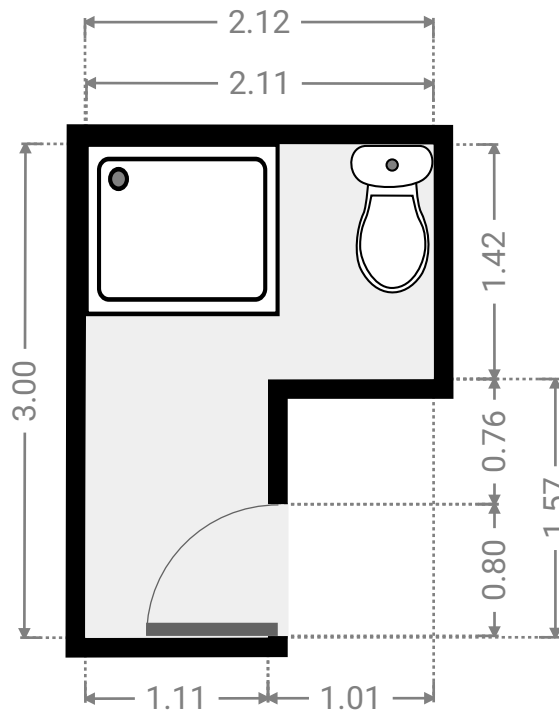
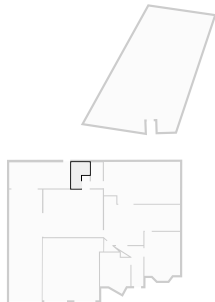

▼ Garage Ground Floor

WIDTH: 6.96 m • LENGTH: 7.11 m
AREA: 46.53 m² • PERIMETER: 28.09 m

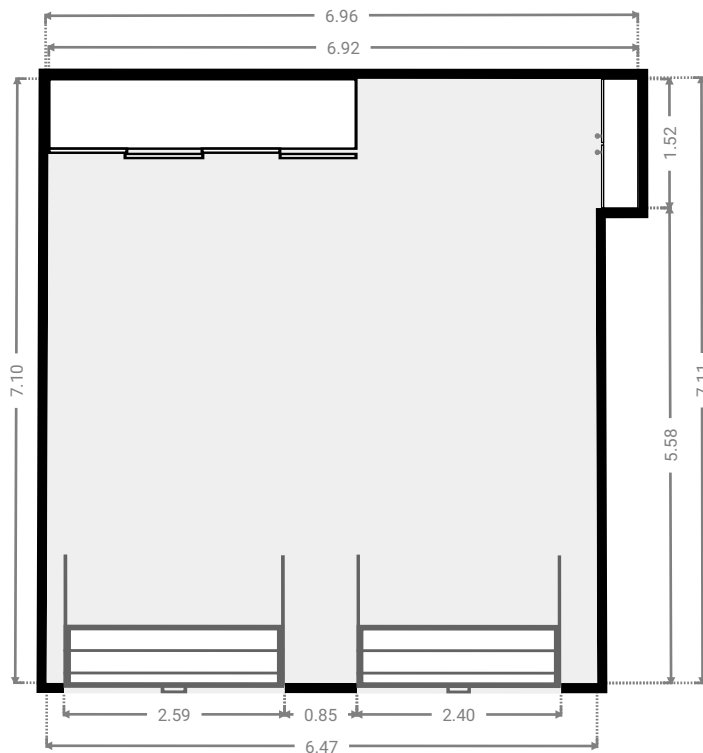
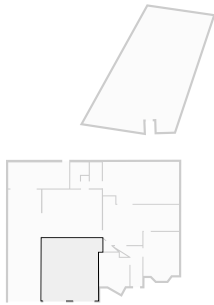

▼ Other Ground Floor

WIDTH: 2.20 m • LENGTH: 1.10 m
AREA: 1.21 m² • PERIMETER: 5.32 m

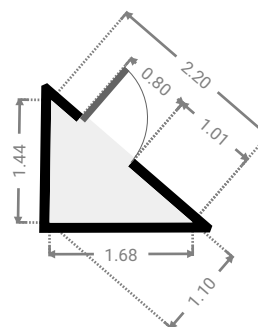
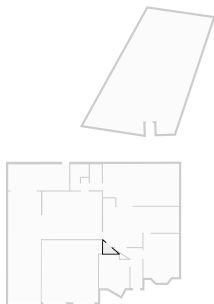

▼ Other
Ground Floor

WIDTH: 8.72 m • LENGTH: 4.80 m
AREA: 40.25 m² • PERIMETER: 27.01 m

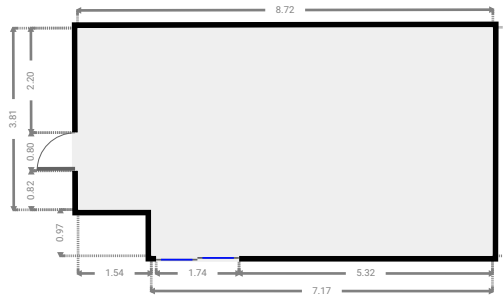
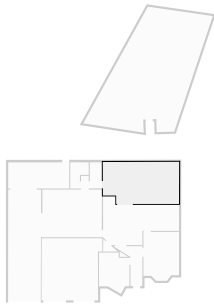

▼ Other
Ground Floor

WIDTH: 3.79 m • LENGTH: 12.68 m
AREA: 47.59 m² • PERIMETER: 32.86 m

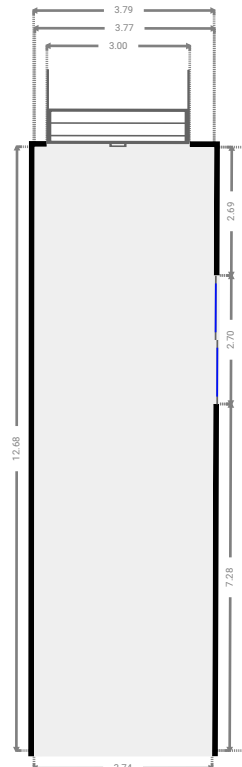
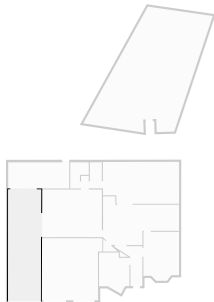

▼ Workshop Ground Floor

WIDTH: 6.98 m • LENGTH: 2.99 m
AREA: 20.85 m² • PERIMETER: 19.93 m

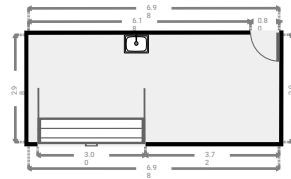
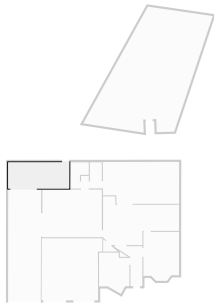

▼ Other Ground Floor

WIDTH: 9.56 m • LENGTH: 17.92 m
AREA: 124.35 m² • PERIMETER: 50.20 m

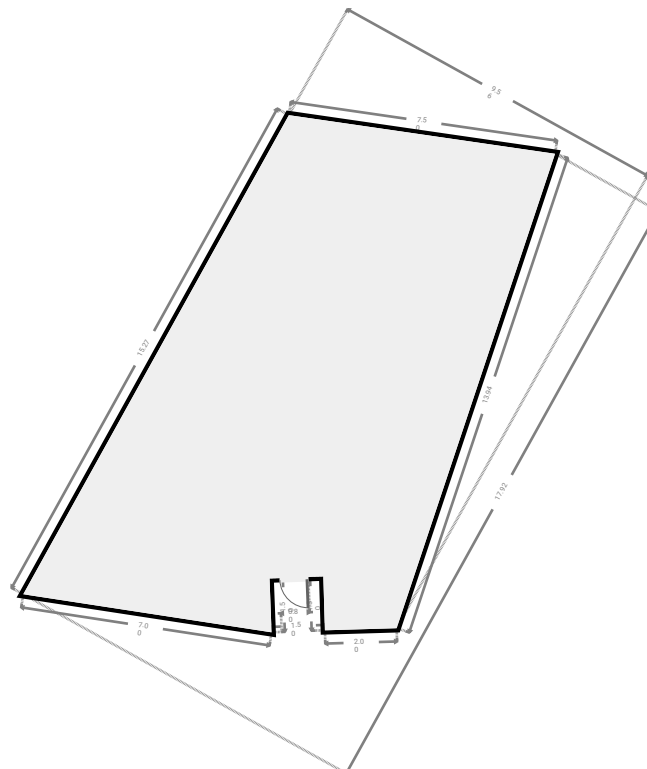
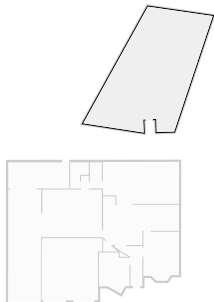

▼ 1st Floor

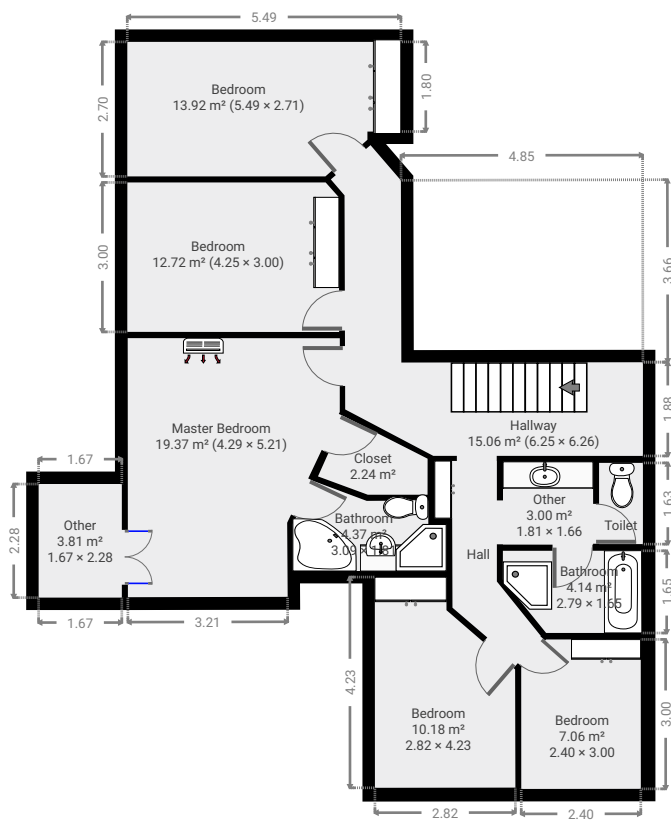

▼ **Bedroom**
1st Floor

WIDTH: 4.23 m • LENGTH: 2.82 m
AREA: 10.18 m² • PERIMETER: 13.35 m

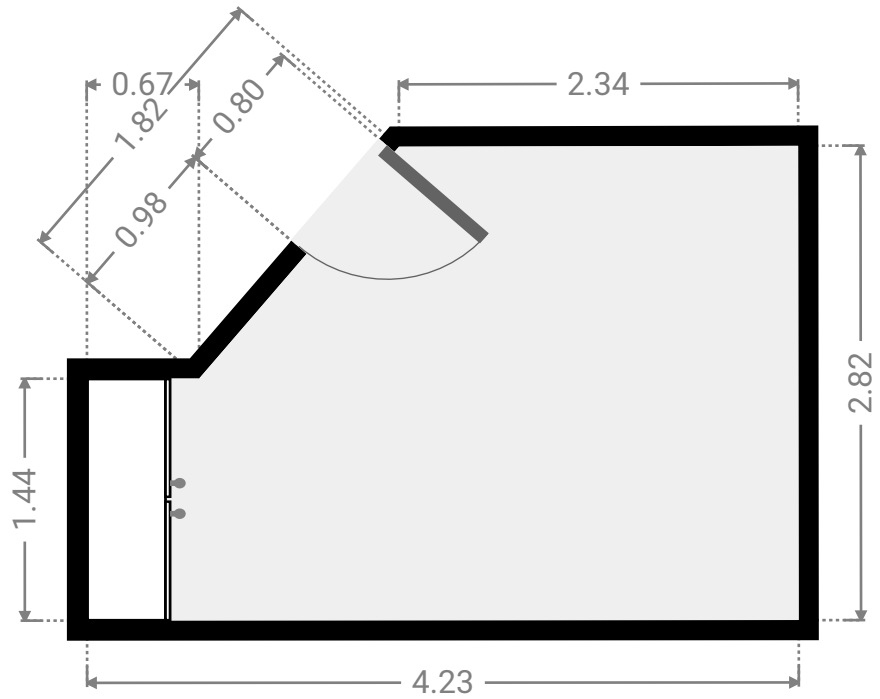
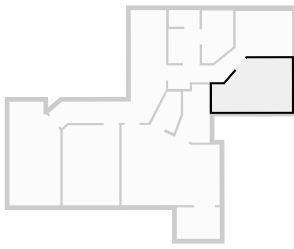

▼ **Bedroom**
1st Floor

WIDTH: 3.00 m • LENGTH: 2.40 m
AREA: 7.06 m² • PERIMETER: 10.49 m

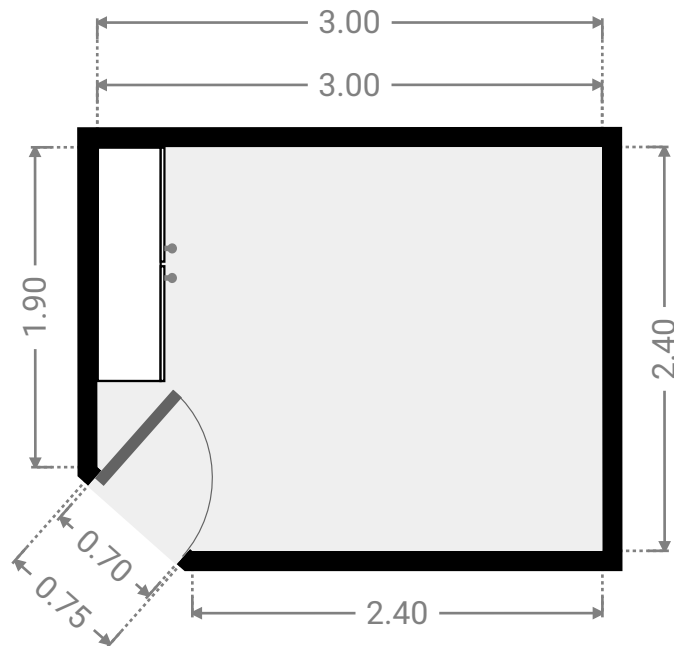
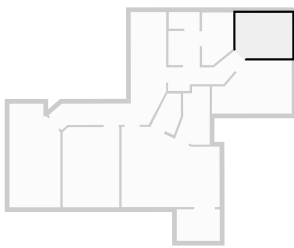

▼ **Hall**
1st Floor

WIDTH: 4.17 m • LENGTH: 2.10 m
AREA: 4.15 m² • PERIMETER: 10.81 m

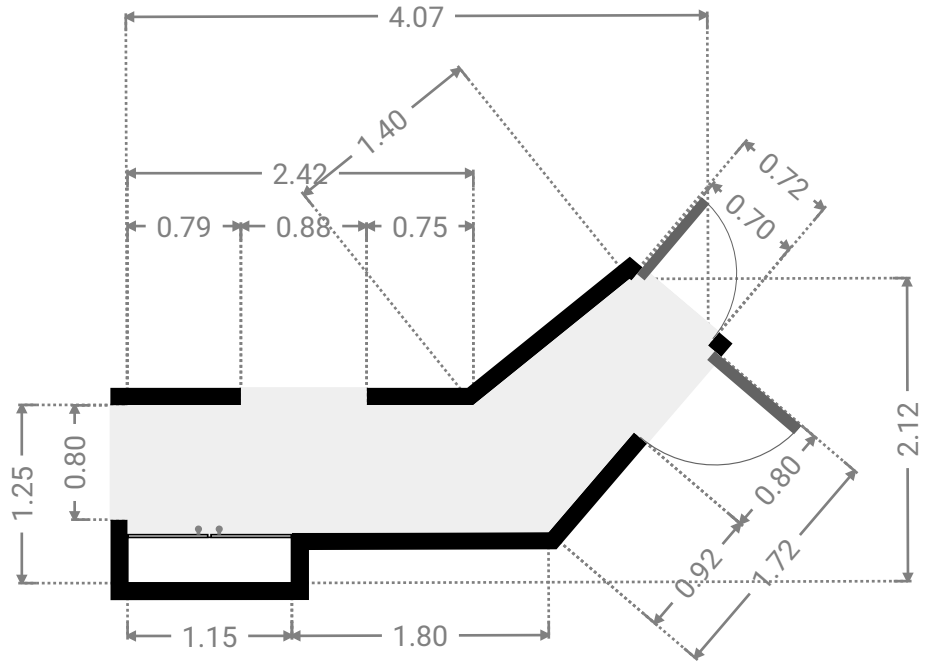
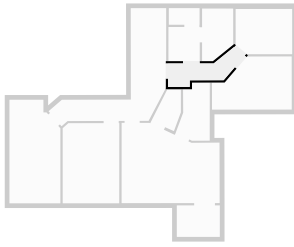

▼ **Bathroom**
1st Floor

WIDTH: 1.65 m • LENGTH: 2.73 m
AREA: 4.14 m² • PERIMETER: 8.32 m

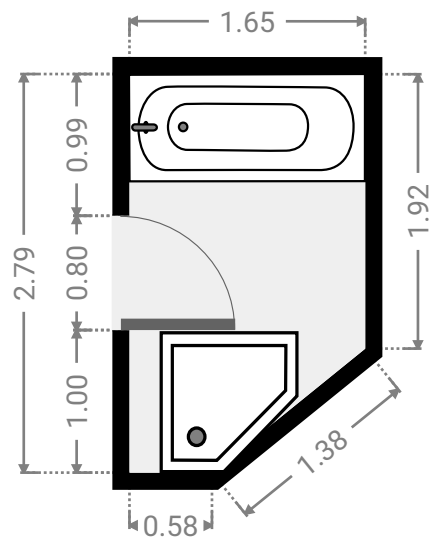
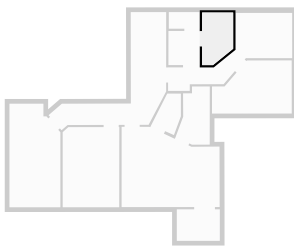

▼ **Toilet**
1st Floor

WIDTH: 1.63 m • LENGTH: 0.88 m
AREA: 1.43 m² • PERIMETER: 5.02 m

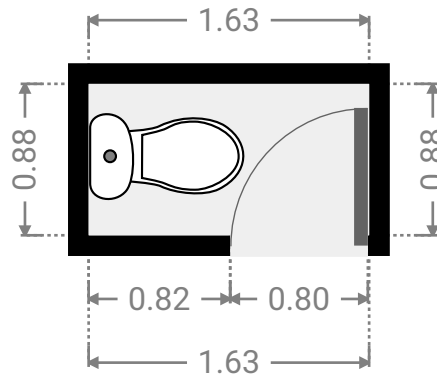
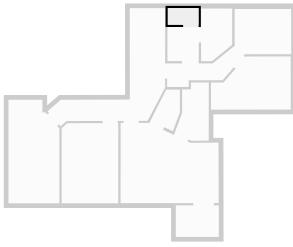

▼ **Other**
1st Floor

WIDTH: 1.69 m • LENGTH: 1.72 m
AREA: 3.00 m² • PERIMETER: 6.94 m

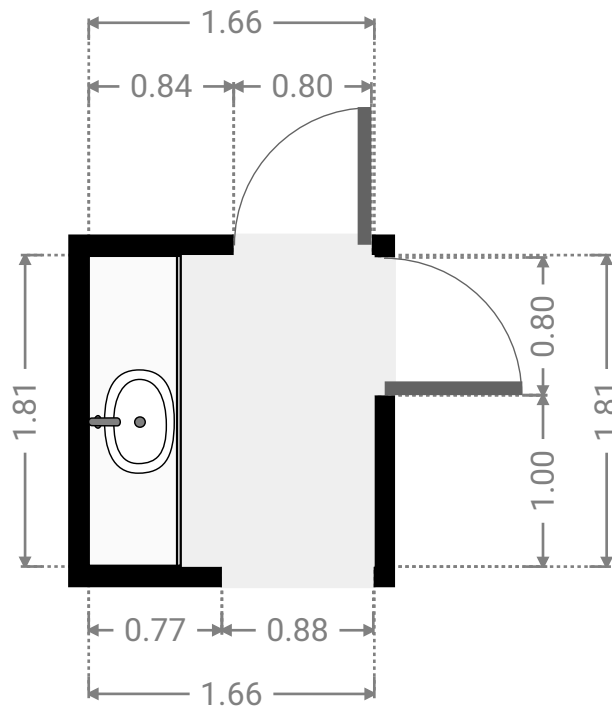
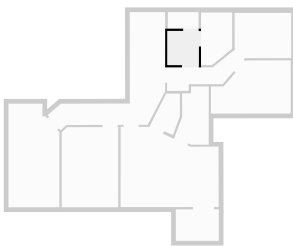

▼ Hallway 1st Floor

WIDTH: 6.91 m • LENGTH: 6.45 m
AREA: 15.06 m² • PERIMETER: 23.30 m

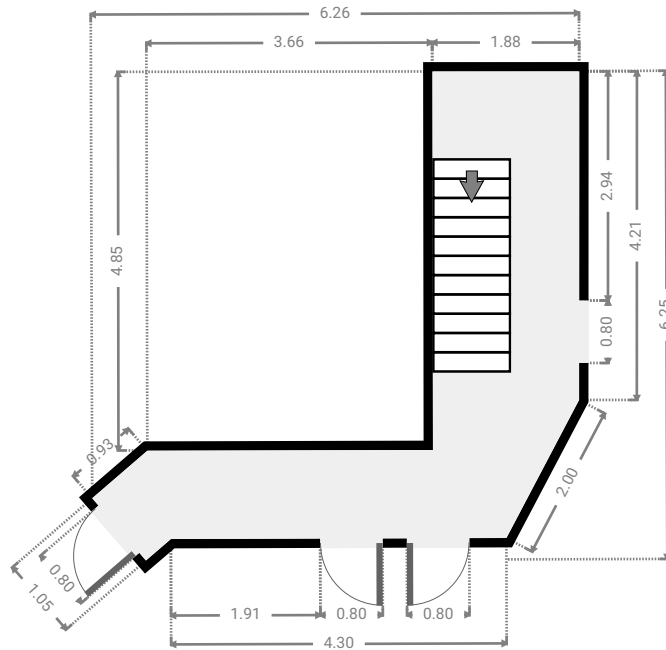
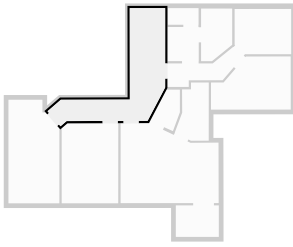

▼ Master Bedroom 1st Floor

WIDTH: 5.21 m • LENGTH: 4.41 m
AREA: 19.37 m² • PERIMETER: 18.09 m

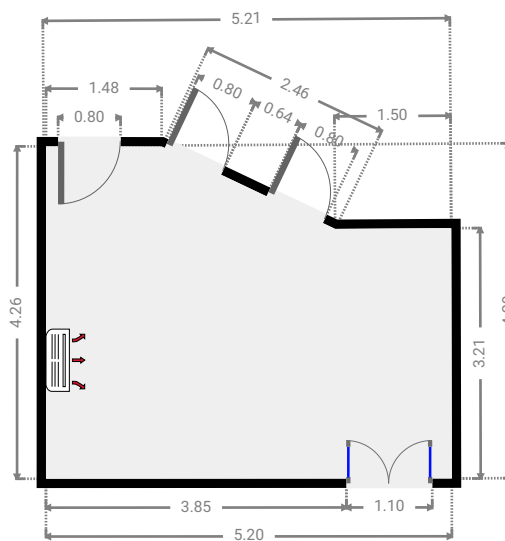
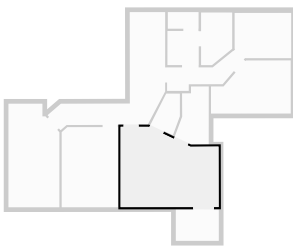

▼ **Closet**
1st Floor

WIDTH: 1.29 m • LENGTH: 2.17 m
AREA: 2.24 m² • PERIMETER: 6.17 m

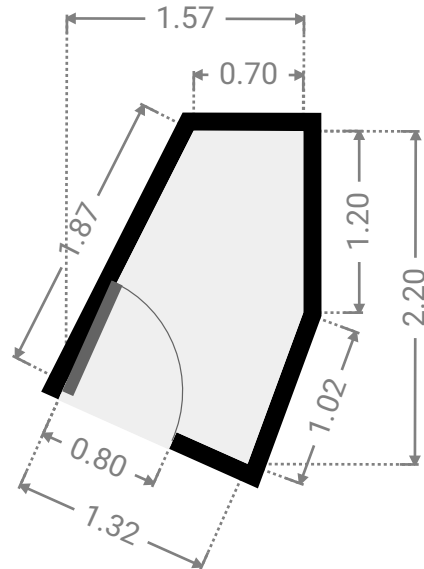
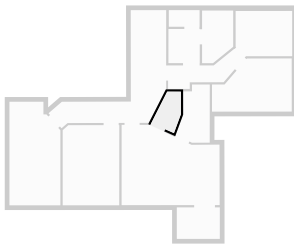

▼ **Bathroom**
1st Floor

WIDTH: 2.06 m • LENGTH: 3.49 m
AREA: 4.37 m² • PERIMETER: 9.13 m

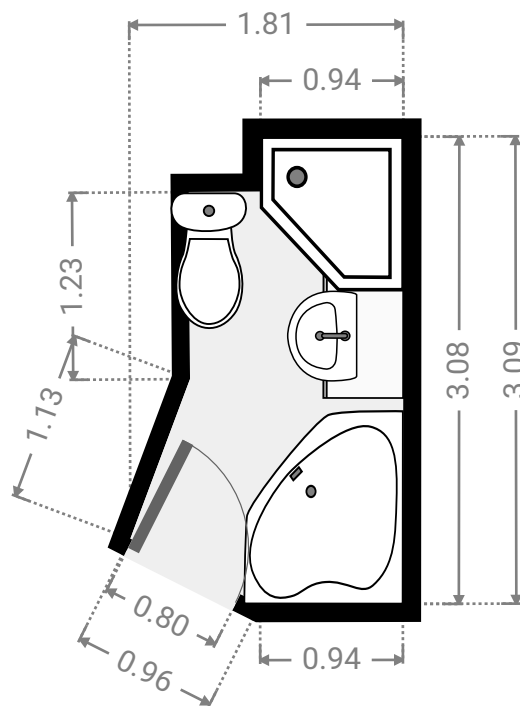
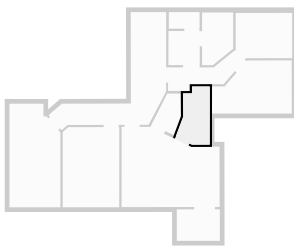

▼ Other
1st Floor

WIDTH: 2.28 m • LENGTH: 1.67 m
AREA: 3.81 m² • PERIMETER: 7.90 m

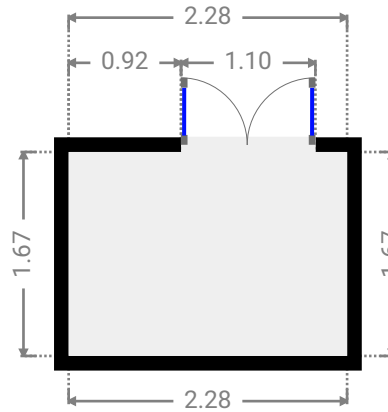
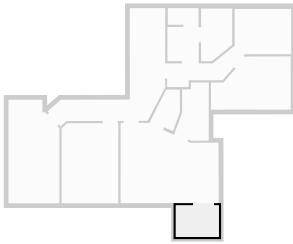

▼ Bedroom
1st Floor

WIDTH: 3.00 m • LENGTH: 4.25 m
AREA: 12.72 m² • PERIMETER: 14.34 m

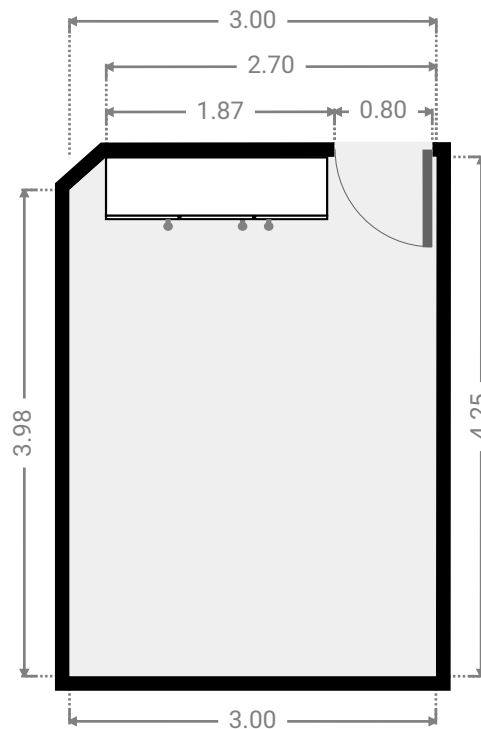
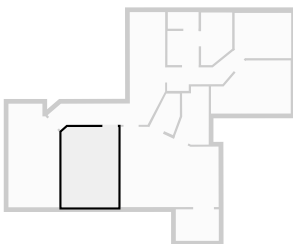

▼ Bedroom 1st Floor

WIDTH: 2.71 m • LENGTH: 5.49 m
AREA: 13.92 m² • PERIMETER: 15.93 m

