

5 Gardner Street

Ground Floor

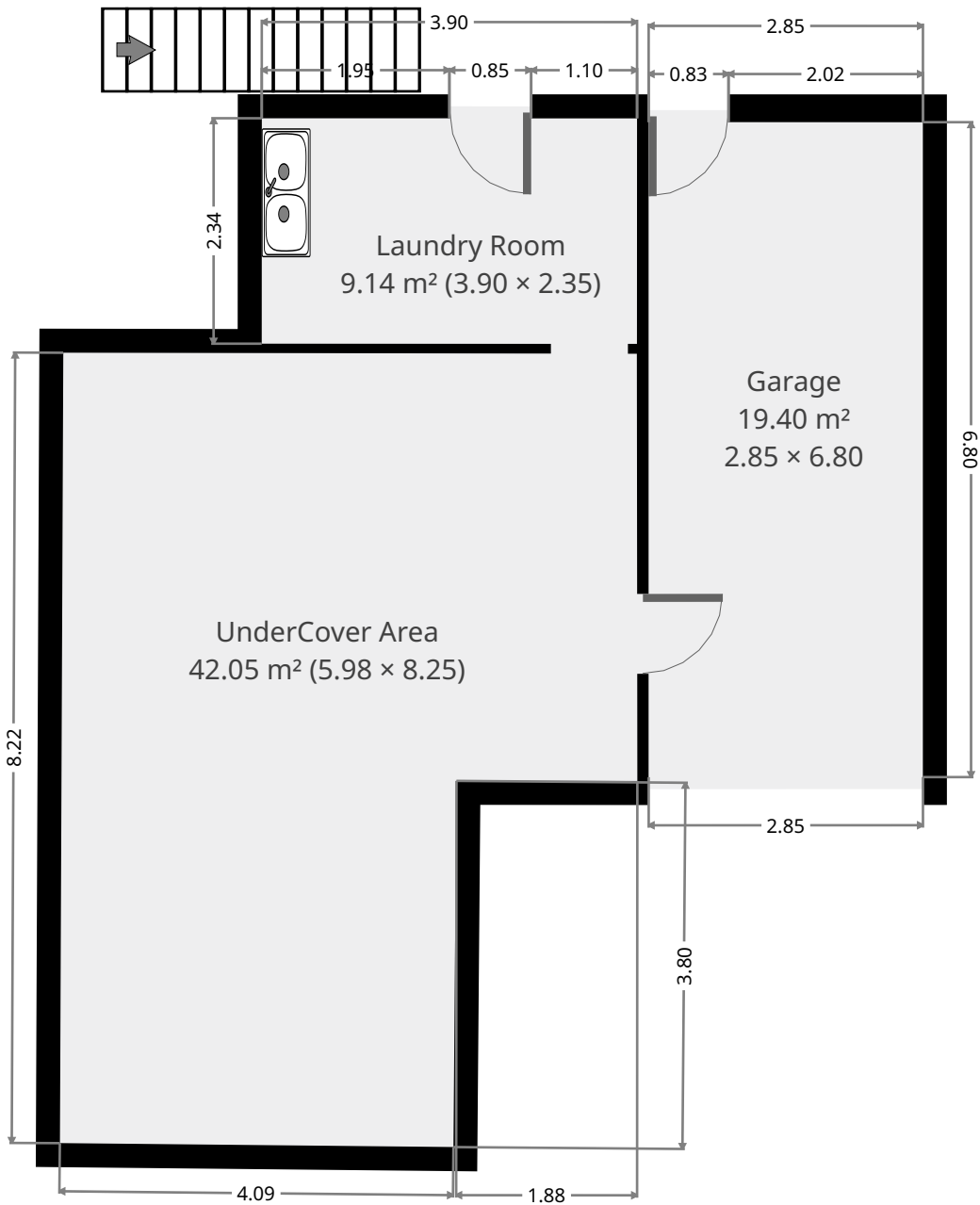

THIS FLOORPLAN IS PROVIDED WITHOUT WARRANTY OF ANY KIND. SENSOPIA DISCLAIMS ANY WARRANTY INCLUDING, WITHOUT LIMITATION, SATISFACTORY QUALITY OR ACCURACY OF DIMENSIONS.



5 Gardner Street

Laundry Room

Width: 2.35 m
Length: 3.90 m
Area: 9.14 m²
Perimeter: 12.49 m

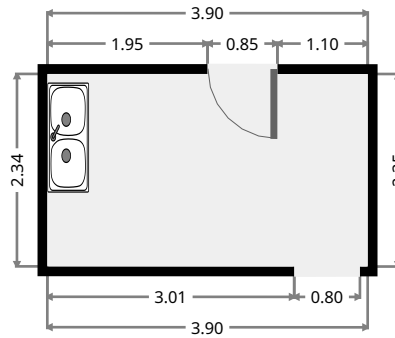
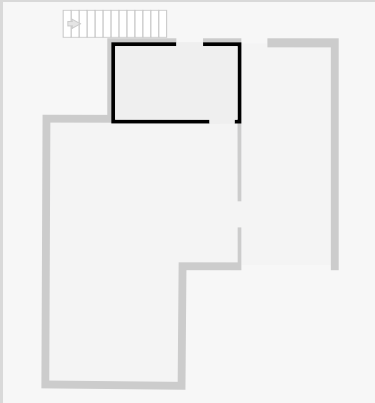

UnderCover Area

Width: 5.98 m
Length: 8.25 m
Area: 42.05 m²
Perimeter: 28.39 m

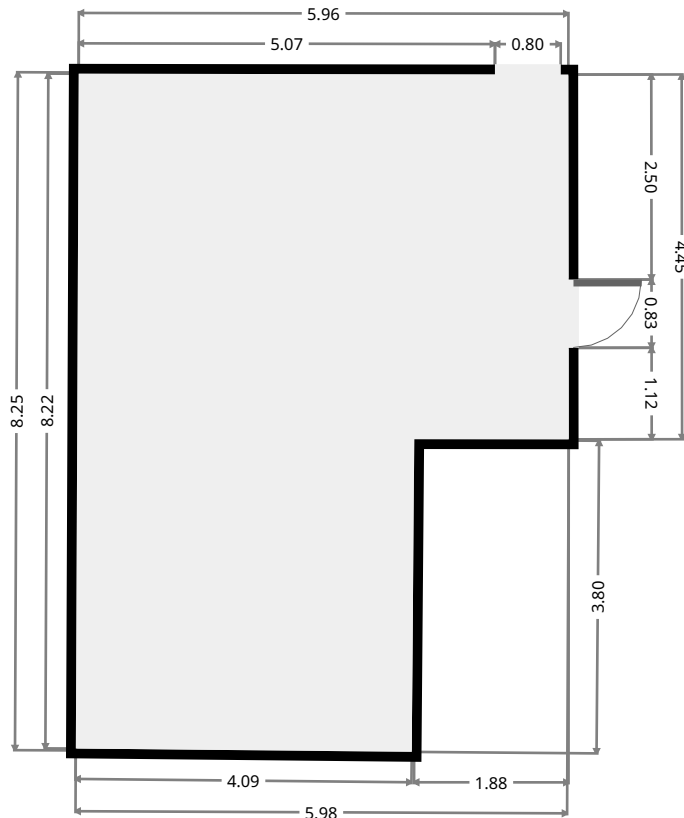
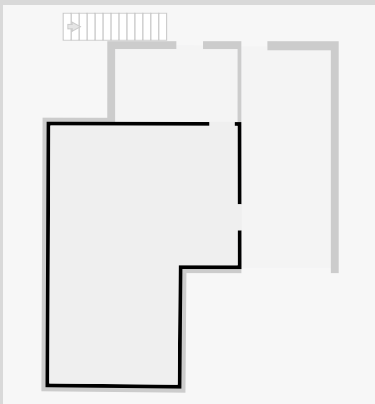

THIS FLOORPLAN IS PROVIDED WITHOUT WARRANTY OF ANY KIND. SENSOPIA DISCLAIMS ANY WARRANTY INCLUDING, WITHOUT LIMITATION, SATISFACTORY QUALITY OR ACCURACY OF DIMENSIONS.

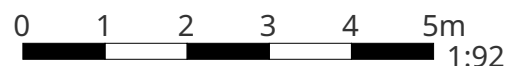

5 Gardner Street

Garage

Width: 2.85 m
Length: 6.80 m
Area: 19.40 m²
Perimeter: 19.31 m

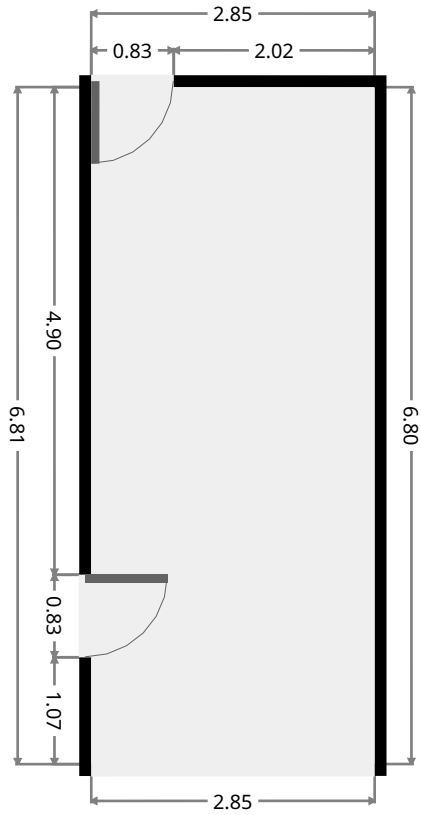
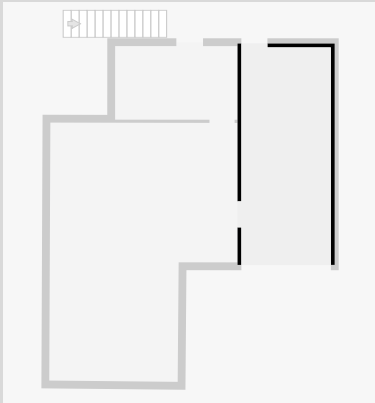

5 Gardner Street

1st Floor

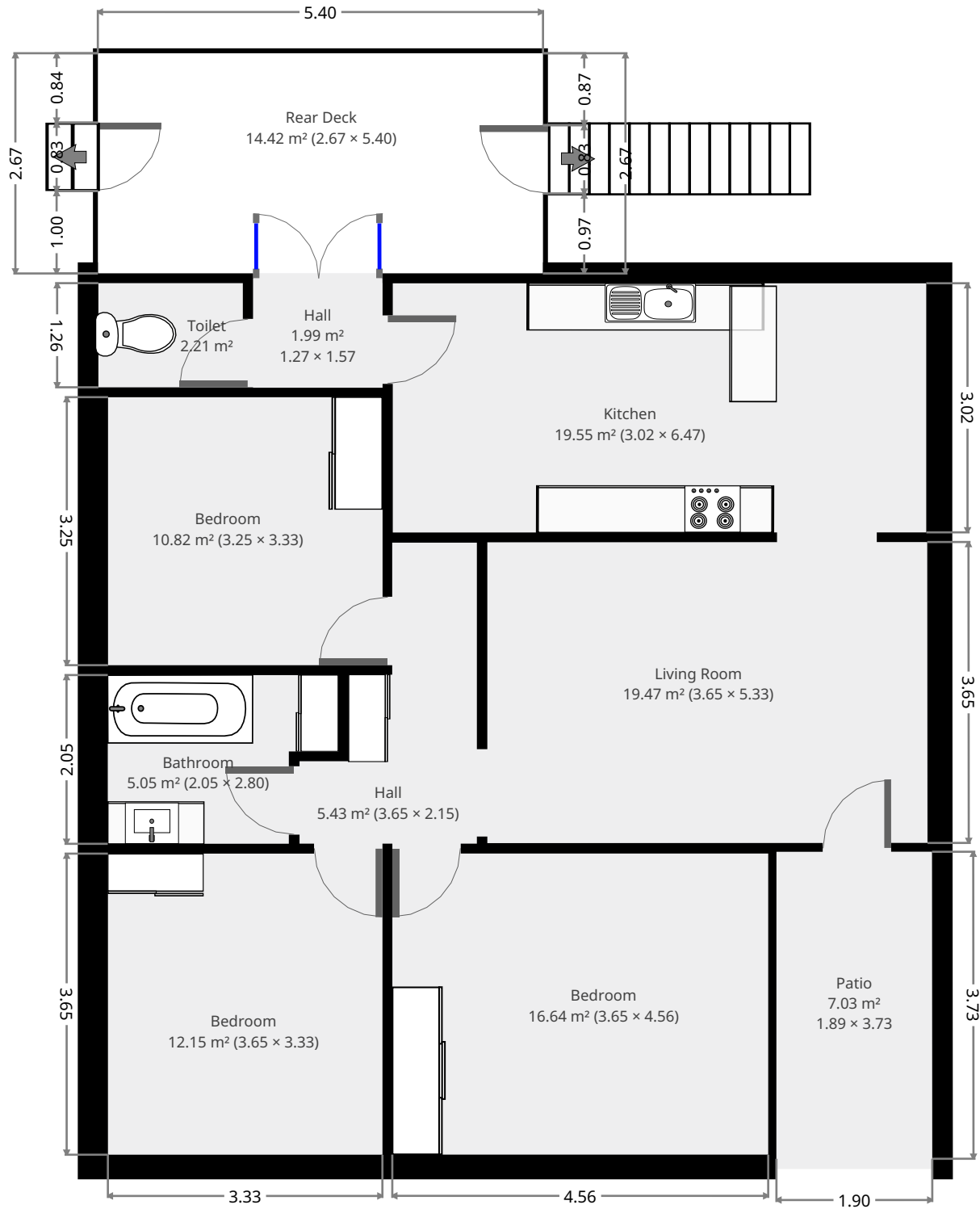

THIS FLOORPLAN IS PROVIDED WITHOUT WARRANTY OF ANY KIND. SENSOPIA DISCLAIMS ANY WARRANTY INCLUDING, WITHOUT LIMITATION, SATISFACTORY QUALITY OR ACCURACY OF DIMENSIONS.



5 Gardner Street

Living Room

Width: 3.65 m
 Length: 5.33 m
 Area: 19.47 m²
 Perimeter: 17.97 m

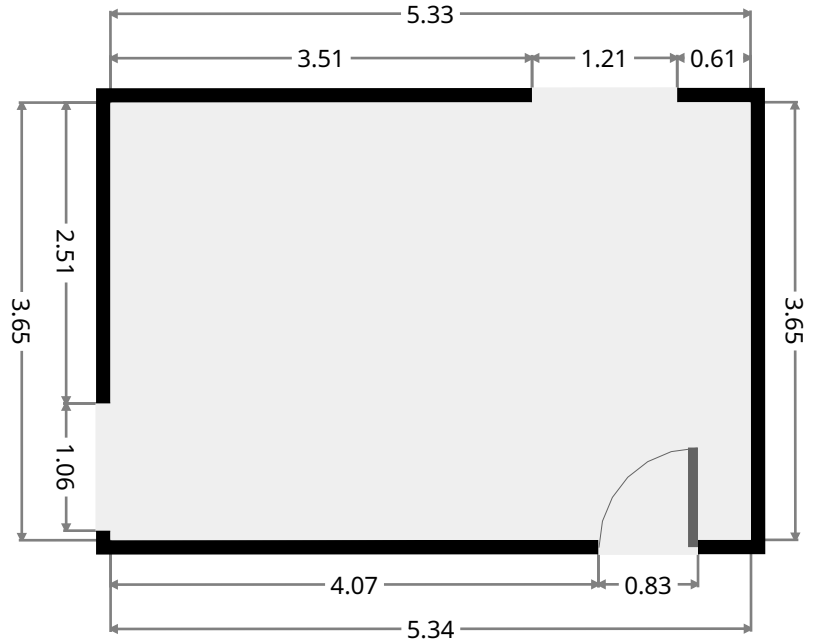
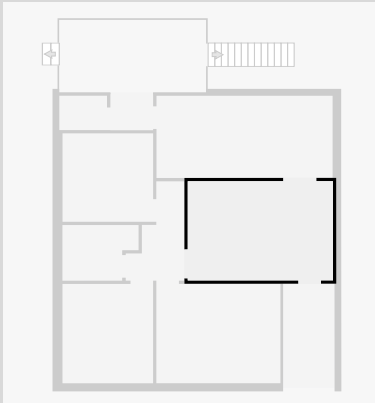

Kitchen

Width: 3.02 m
 Length: 6.47 m
 Area: 19.55 m²
 Perimeter: 18.98 m

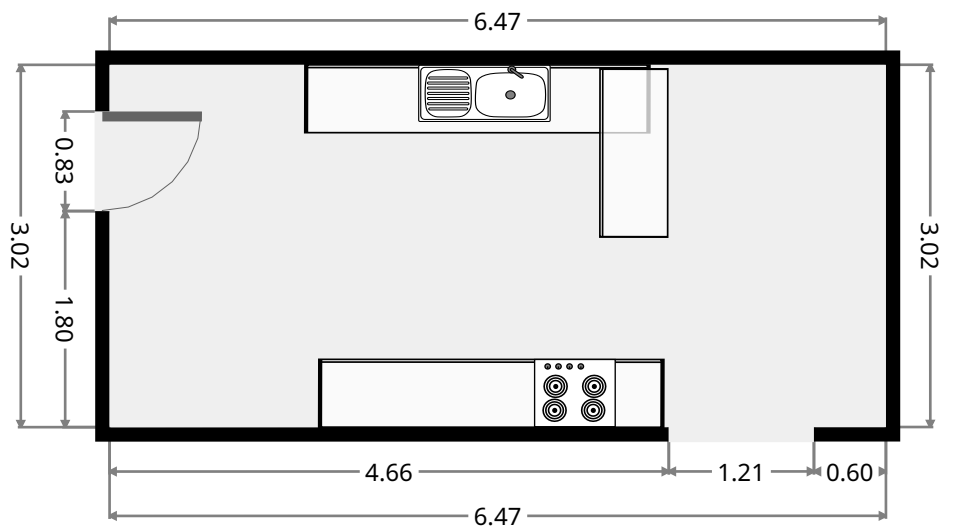
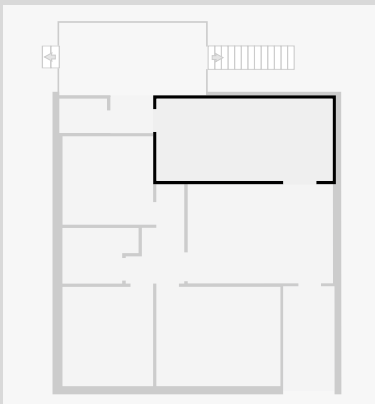

THIS FLOORPLAN IS PROVIDED WITHOUT WARRANTY OF ANY KIND. SENSOPIA DISCLAIMS ANY WARRANTY INCLUDING, WITHOUT LIMITATION, SATISFACTORY QUALITY OR ACCURACY OF DIMENSIONS.

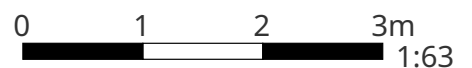

5 Gardner Street

Hall

Width: 2.15 m
 Length: 3.65 m
 Area: 5.43 m²
 Perimeter: 11.60 m

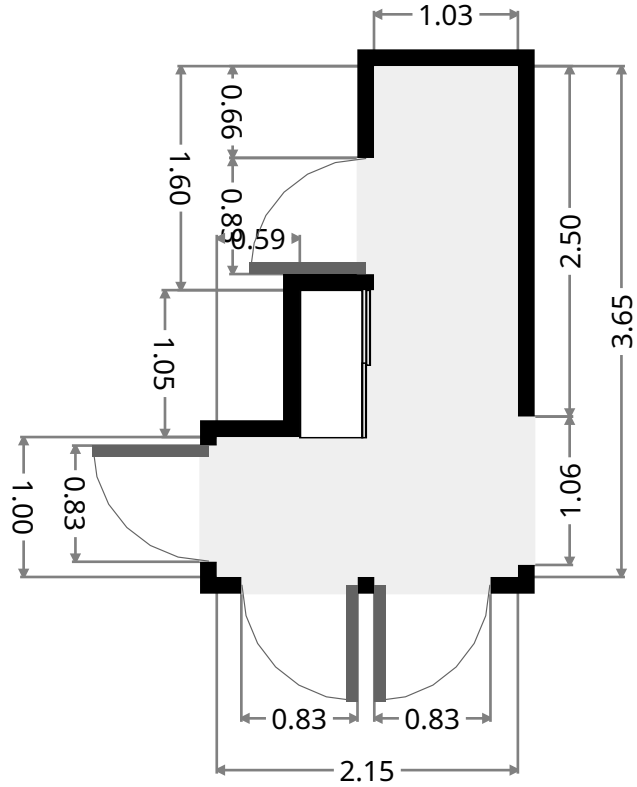
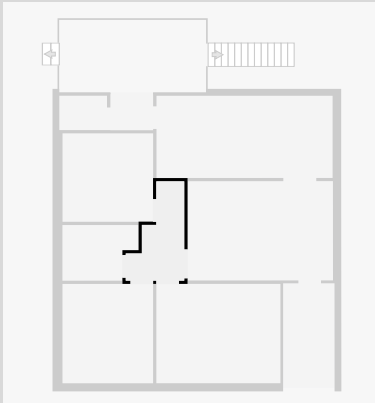

Bedroom

Width: 3.65 m
 Length: 4.56 m
 Area: 16.64 m²
 Perimeter: 16.42 m

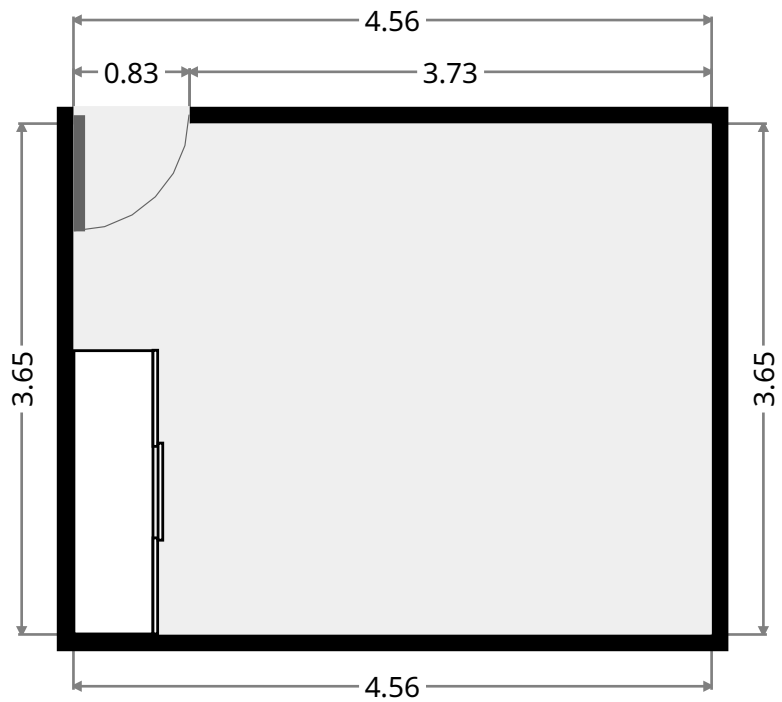
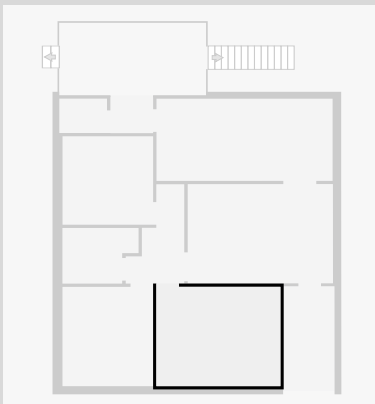

5 Gardner Street

Bedroom

Width: 3.33 m
Length: 3.65 m
Area: 12.15 m²
Perimeter: 13.96 m

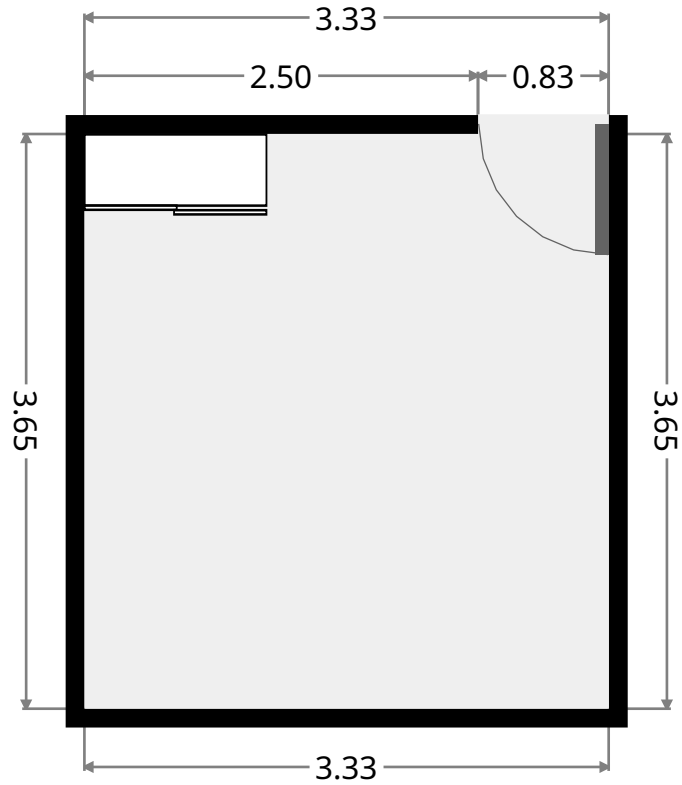
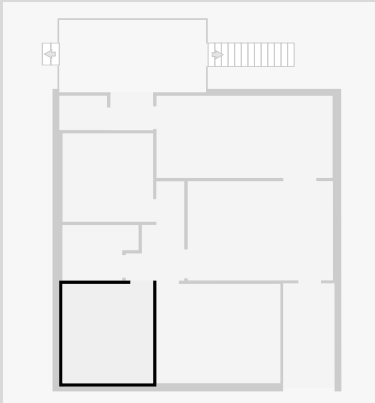

Bathroom

Width: 2.05 m
Length: 2.80 m
Area: 5.05 m²
Perimeter: 9.69 m

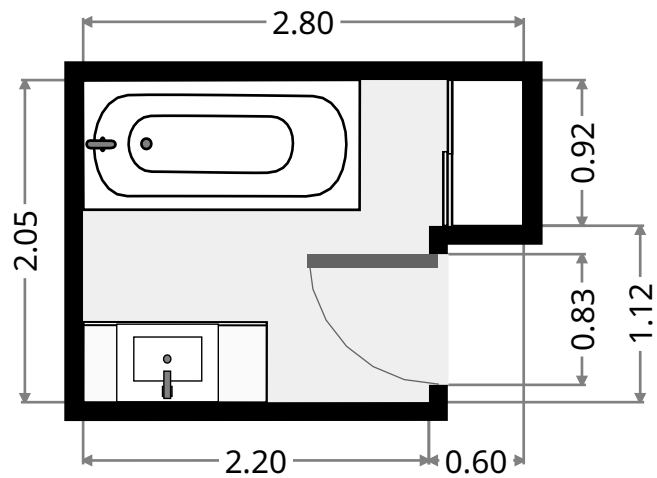
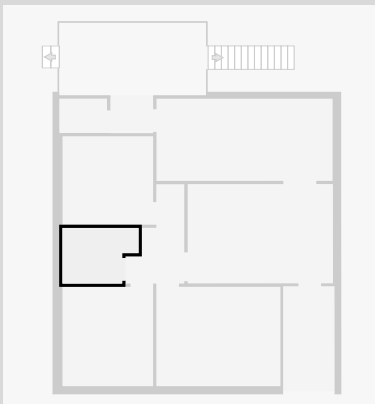

5 Gardner Street

Bedroom

Width: 3.25 m
Length: 3.33 m
Area: 10.82 m²
Perimeter: 13.16 m

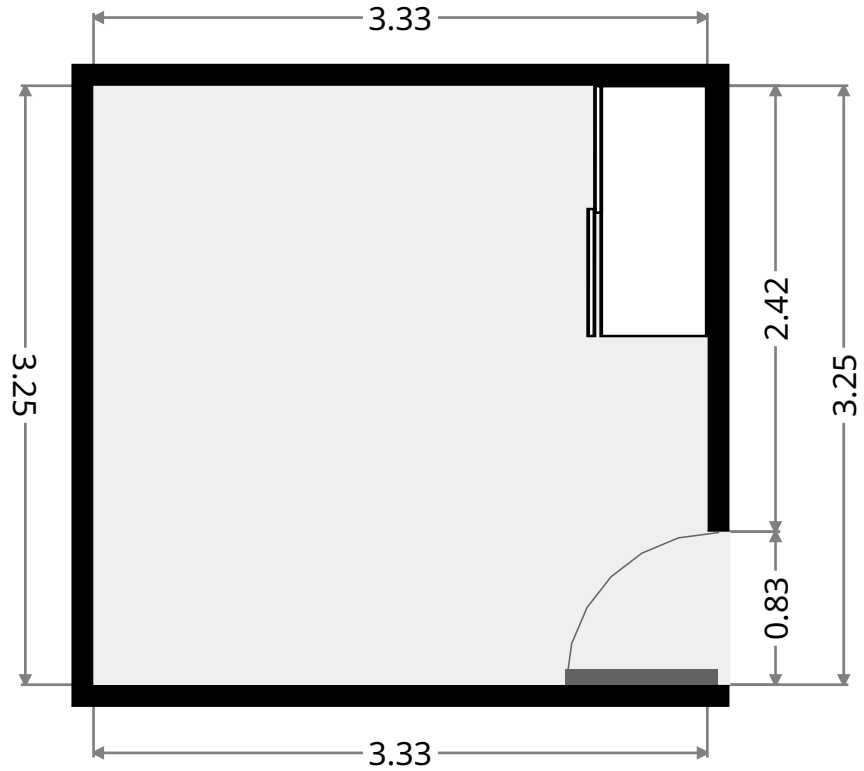
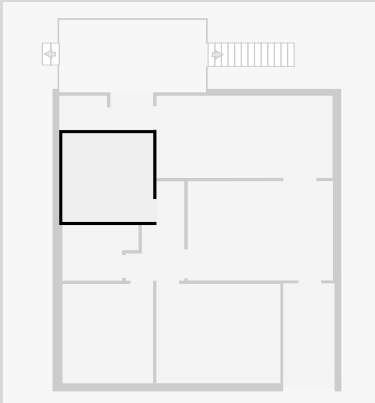

Hall

Width: 1.27 m
Length: 1.57 m
Area: 1.99 m²
Perimeter: 5.68 m

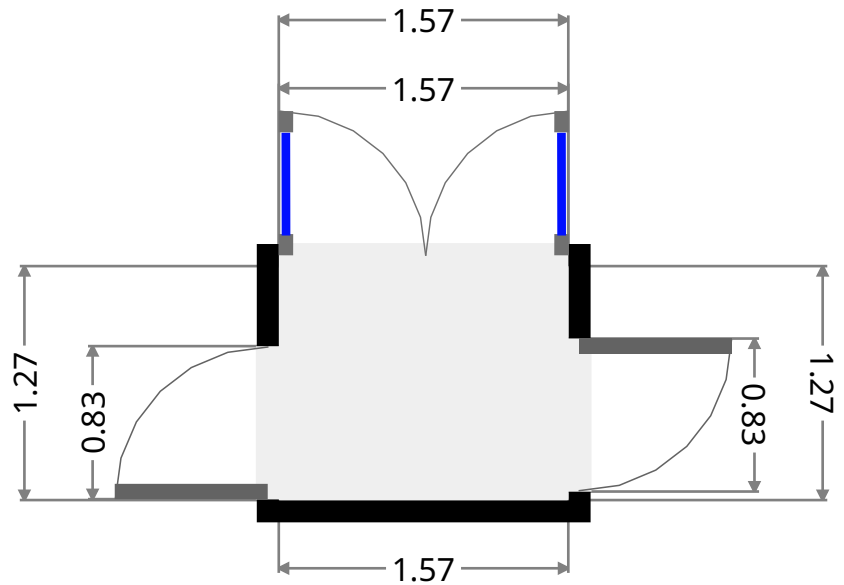
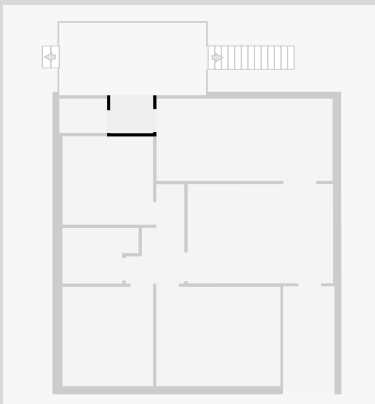

5 Gardner Street

Toilet / Half Bath

Width: 1.26 m
 Length: 1.75 m
 Area: 2.21 m²
 Perimeter: 6.03 m

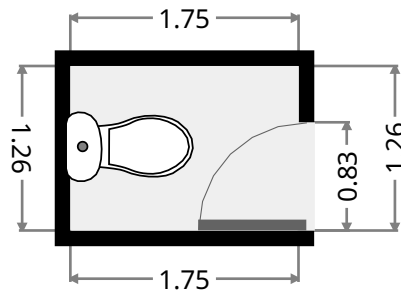
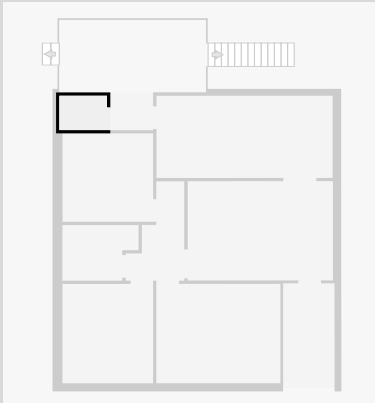

Rear Deck

Width: 2.67 m
 Length: 5.40 m
 Area: 14.42 m²
 Perimeter: 16.14 m

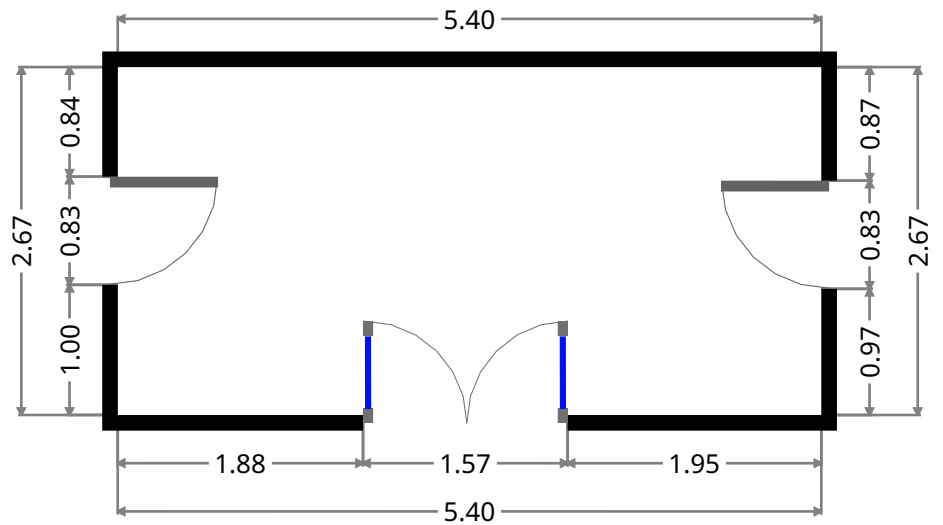
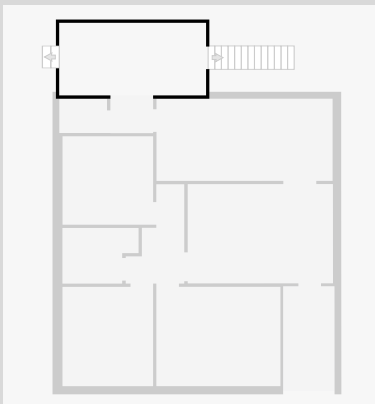

5 Gardner Street

Patio

Width: 1.89 m
Length: 3.73 m
Area: 7.03 m²
Perimeter: 11.22 m

