

# 5 Frangipani Court

## Ground Floor



THIS FLOORPLAN IS PROVIDED WITHOUT WARRANTY OF ANY KIND. SENSOPIA DISCLAIMS ANY WARRANTY INCLUDING, WITHOUT LIMITATION, SATISFACTORY QUALITY OR ACCURACY OF DIMENSIONS.



# 5 Frangipani Court

## Bathroom

Width: 1.76 m  
Length: 2.98 m  
Area: 5.28 m<sup>2</sup>  
Perimeter: 9.50 m

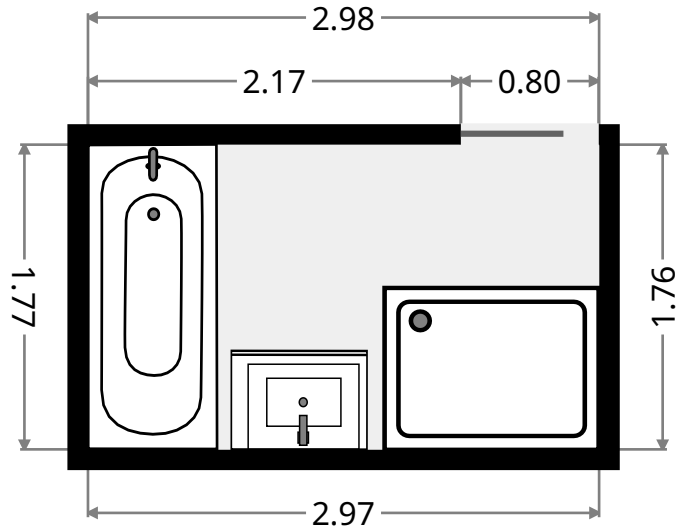
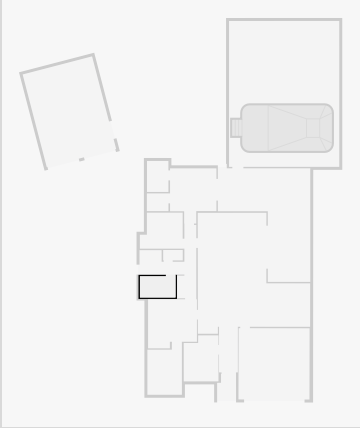

## Entry

Width: 1.58 m  
Length: 2.14 m  
Area: 3.15 m<sup>2</sup>  
Perimeter: 7.45 m

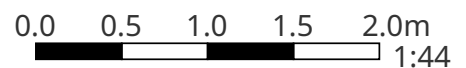
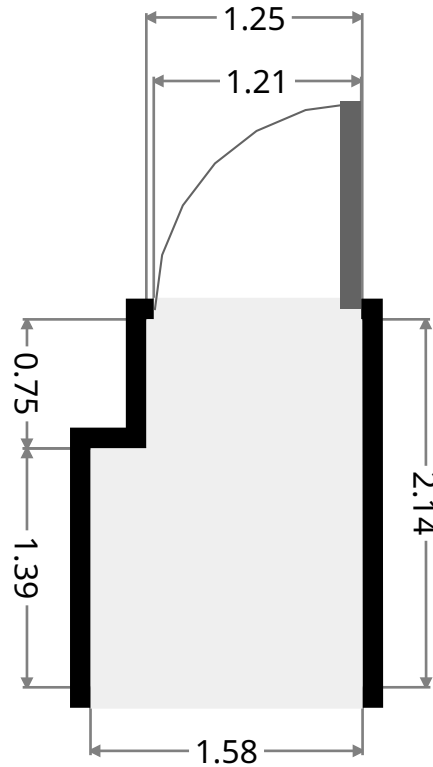
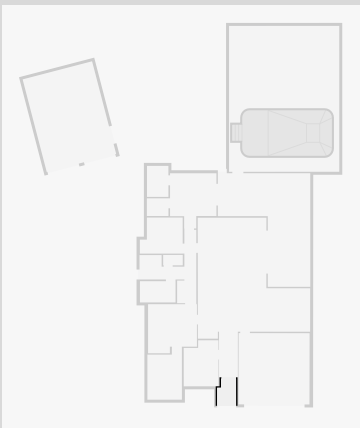

# 5 Frangipani Court

## Shed

Width: 6.00 m  
 Length: 8.00 m  
 Area: 47.98 m<sup>2</sup>  
 Perimeter: 27.99 m

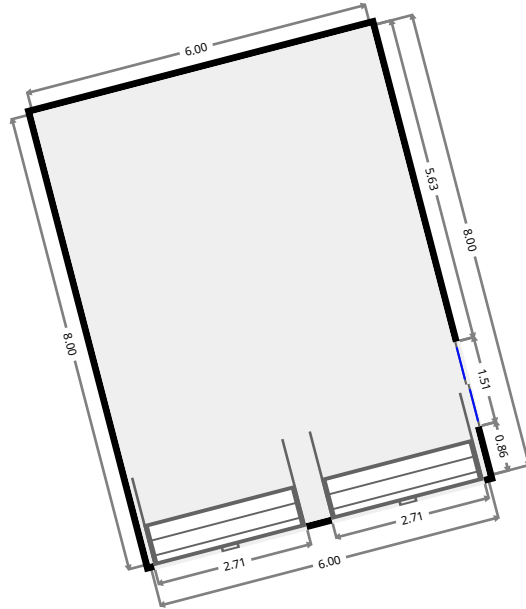
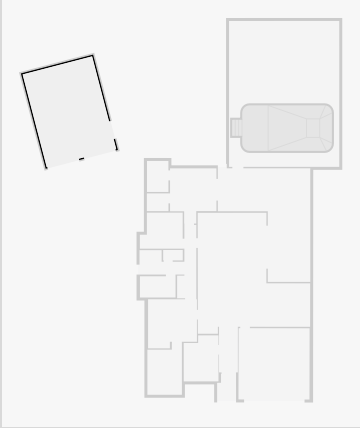

## Pool Area

Width: 9.22 m  
 Length: 12.20 m  
 Area: 112.45 m<sup>2</sup>  
 Perimeter: 42.83 m

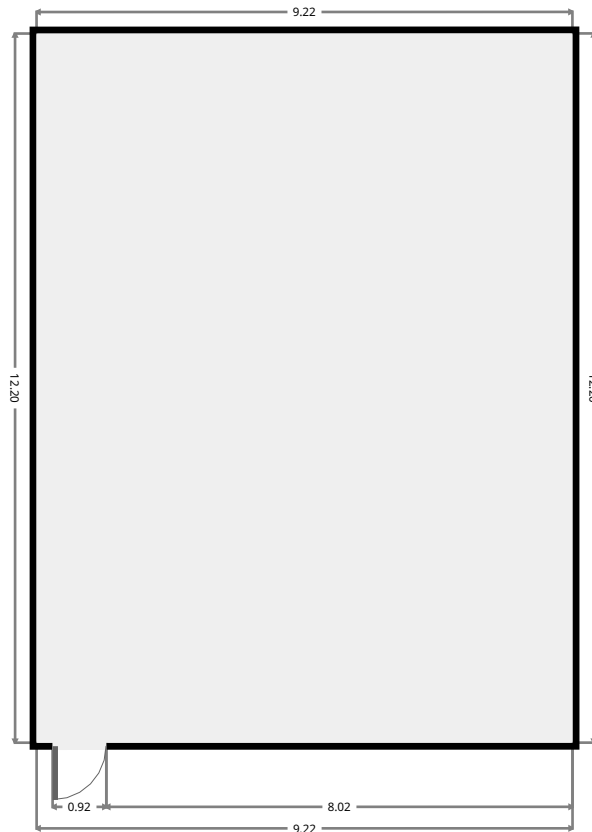
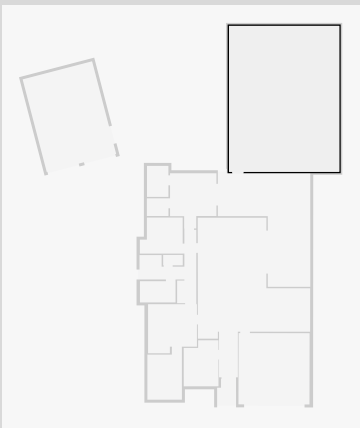

THIS FLOORPLAN IS PROVIDED WITHOUT WARRANTY OF ANY KIND. SENSOPIA DISCLAIMS ANY WARRANTY INCLUDING, WITHOUT LIMITATION, SATISFACTORY QUALITY OR ACCURACY OF DIMENSIONS.

# 5 Frangipani Court

## Outdoor Area

Width: 7.73 m  
 Length: 9.50 m  
 Area: 48.72 m<sup>2</sup>  
 Perimeter: 34.45 m

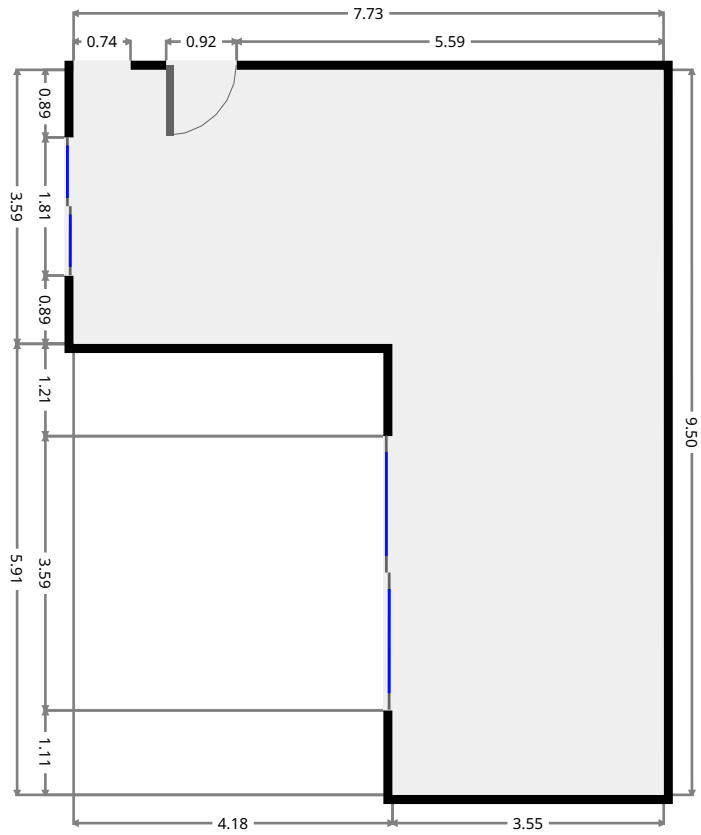
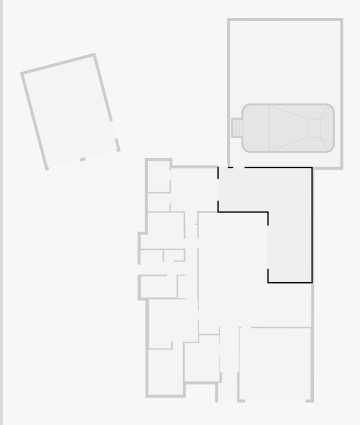

## WIR

Width: 1.48 m  
 Length: 1.81 m  
 Area: 2.67 m<sup>2</sup>  
 Perimeter: 6.57 m

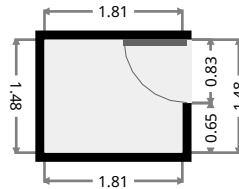
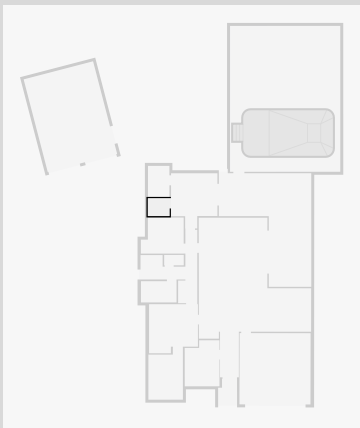

# 5 Frangipani Court

## Ensuite

Width: 1.79 m  
 Length: 2.59 m  
 Area: 4.64 m<sup>2</sup>  
 Perimeter: 8.76 m

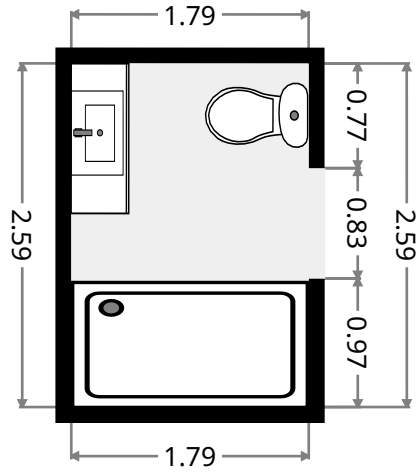
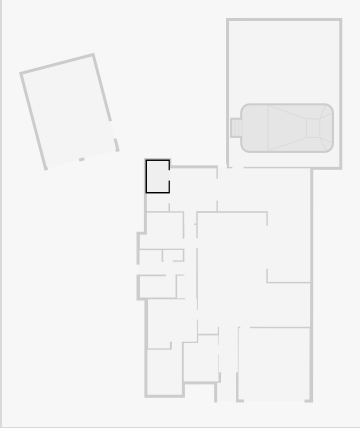

## Master Bedroom

Width: 3.88 m  
 Length: 4.62 m  
 Area: 14.93 m<sup>2</sup>  
 Perimeter: 16.99 m

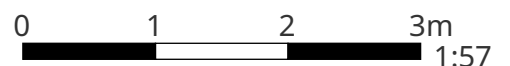
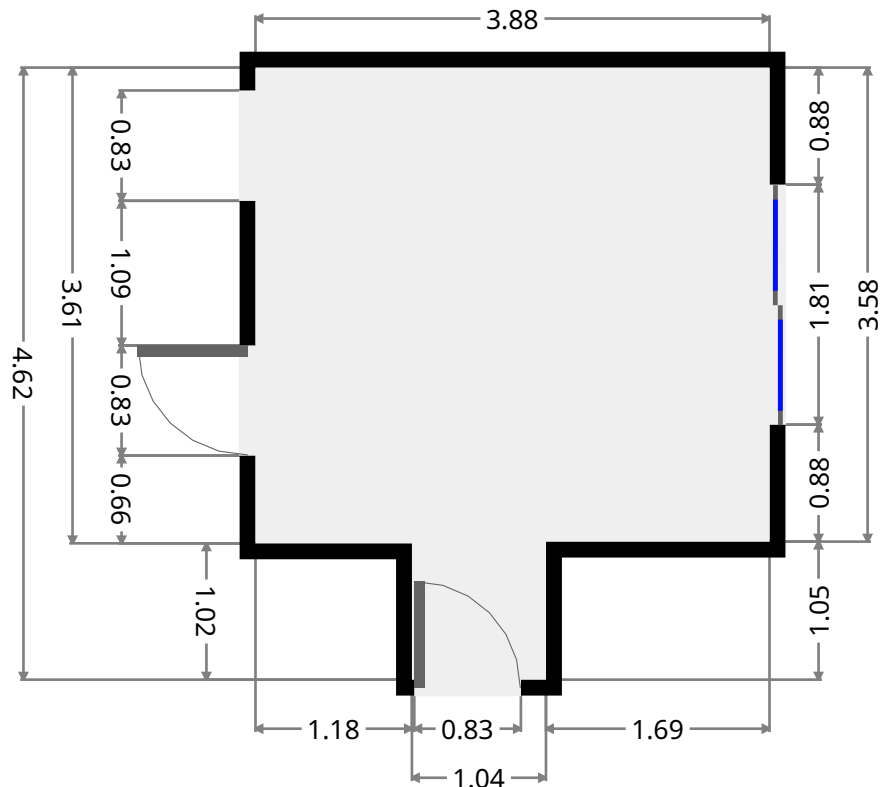
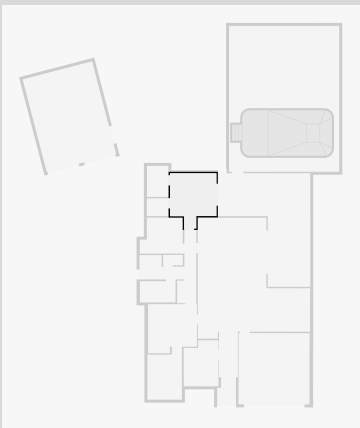

THIS FLOORPLAN IS PROVIDED WITHOUT WARRANTY OF ANY KIND. SENSOPIA DISCLAIMS ANY WARRANTY INCLUDING, WITHOUT LIMITATION, SATISFACTORY QUALITY OR ACCURACY OF DIMENSIONS.

# 5 Frangipani Court

## Bedroom

Width: 3.01 m  
 Length: 3.58 m  
 Area: 9.70 m<sup>2</sup>  
 Perimeter: 13.19 m

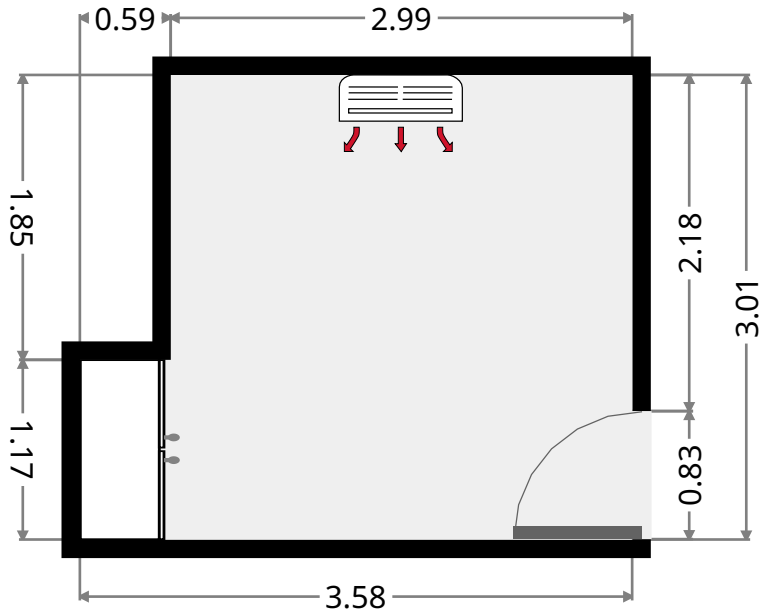
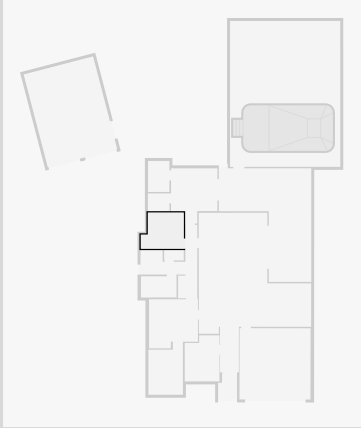

## Hall

Width: 1.58 m  
 Length: 3.70 m  
 Area: 5.82 m<sup>2</sup>  
 Perimeter: 10.54 m

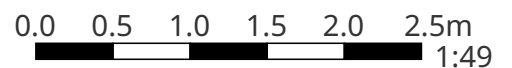
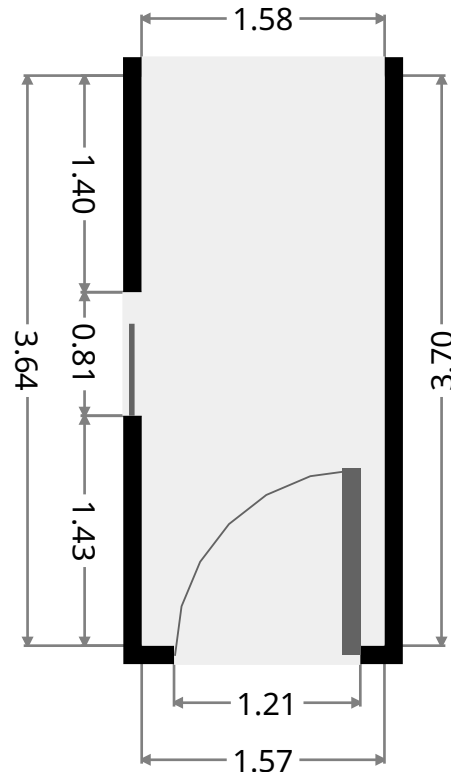
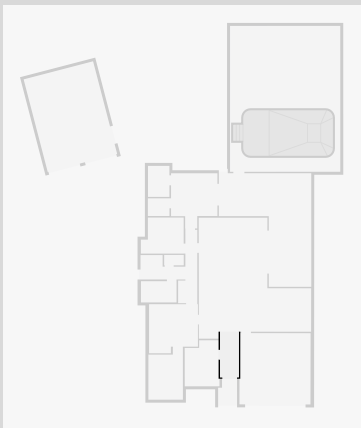

THIS FLOORPLAN IS PROVIDED WITHOUT WARRANTY OF ANY KIND. SENSOPIA DISCLAIMS ANY WARRANTY INCLUDING, WITHOUT LIMITATION, SATISFACTORY QUALITY OR ACCURACY OF DIMENSIONS.

# 5 Frangipani Court

## Toilet

Width: 0.87 m  
 Length: 1.64 m  
 Area: 1.42 m<sup>2</sup>  
 Perimeter: 5.01 m

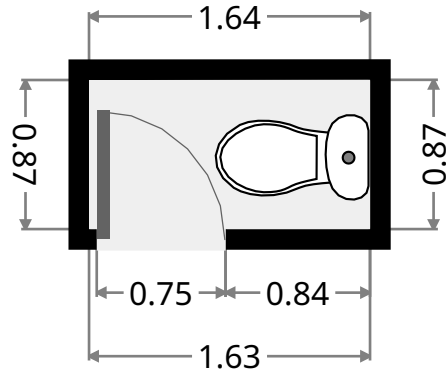
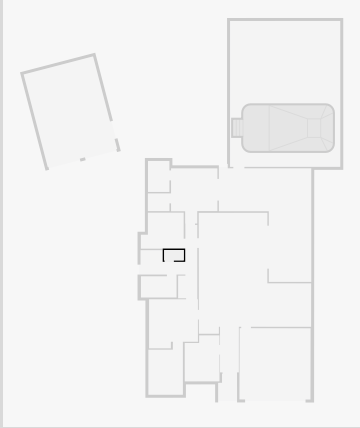

## Laundry Room

Width: 2.04 m  
 Length: 3.66 m  
 Area: 5.70 m<sup>2</sup>  
 Perimeter: 11.39 m

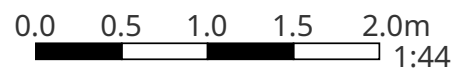
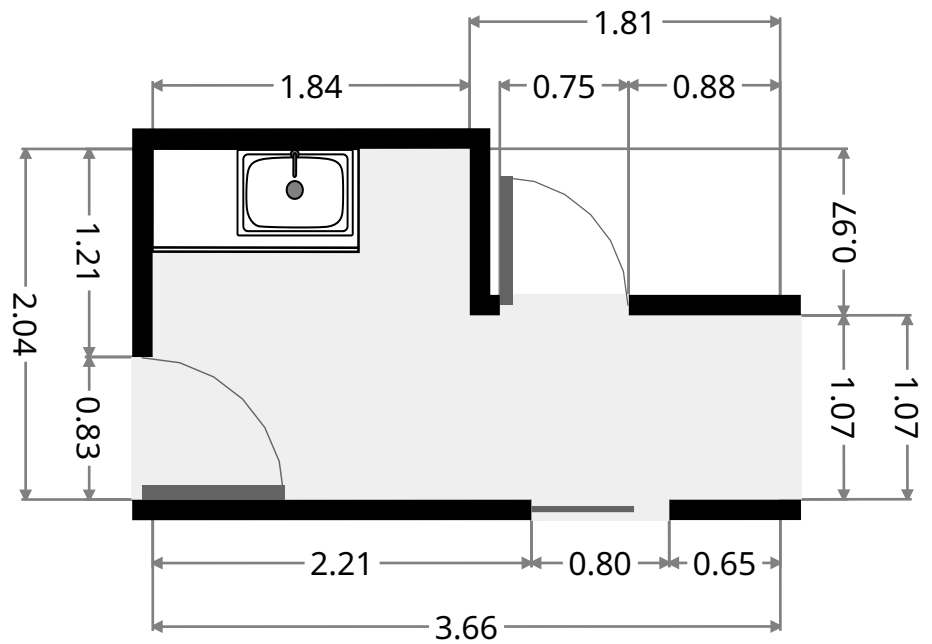
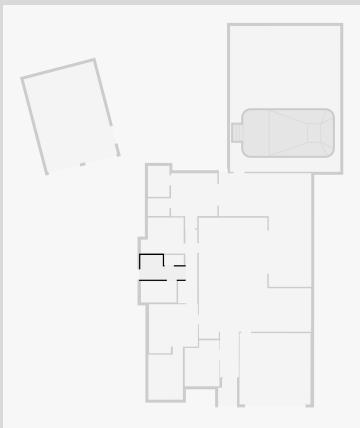

THIS FLOORPLAN IS PROVIDED WITHOUT WARRANTY OF ANY KIND. SENSOPIA DISCLAIMS ANY WARRANTY INCLUDING, WITHOUT LIMITATION, SATISFACTORY QUALITY OR ACCURACY OF DIMENSIONS.

# 5 Frangipani Court

## Hall

Width: 1.60 m  
 Length: 6.14 m  
 Area: 7.27 m<sup>2</sup>  
 Perimeter: 15.49 m

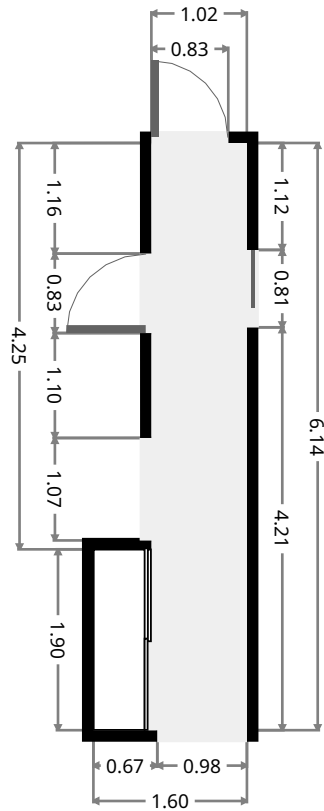
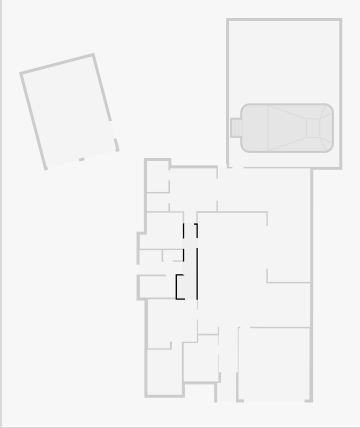

## Bedroom

Width: 2.89 m  
 Length: 4.31 m  
 Area: 11.32 m<sup>2</sup>  
 Perimeter: 14.38 m

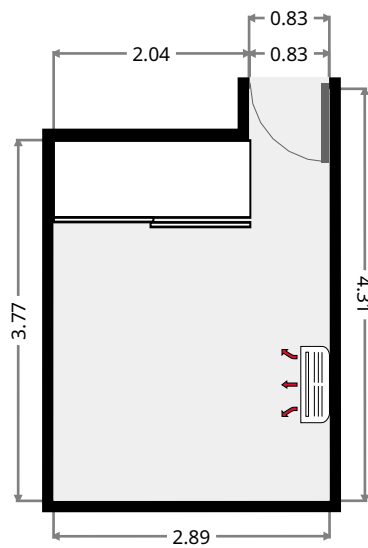
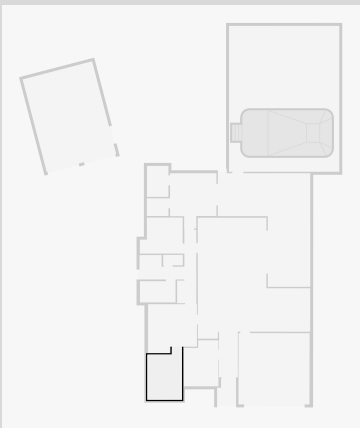



# 5 Frangipani Court

## Living Room

Width: 4.08 m  
 Length: 4.11 m  
 Area: 15.51 m<sup>2</sup>  
 Perimeter: 16.37 m

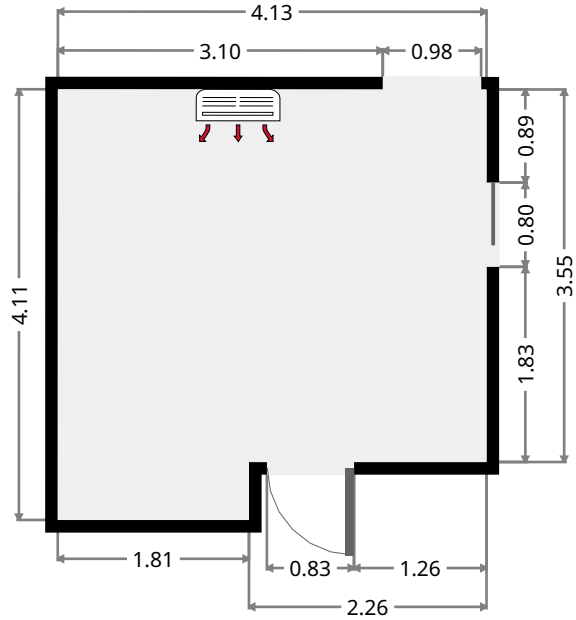
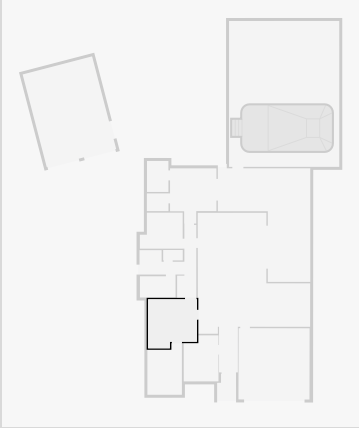

## Garage

Width: 5.94 m  
 Length: 5.96 m  
 Area: 35.38 m<sup>2</sup>  
 Perimeter: 23.79 m

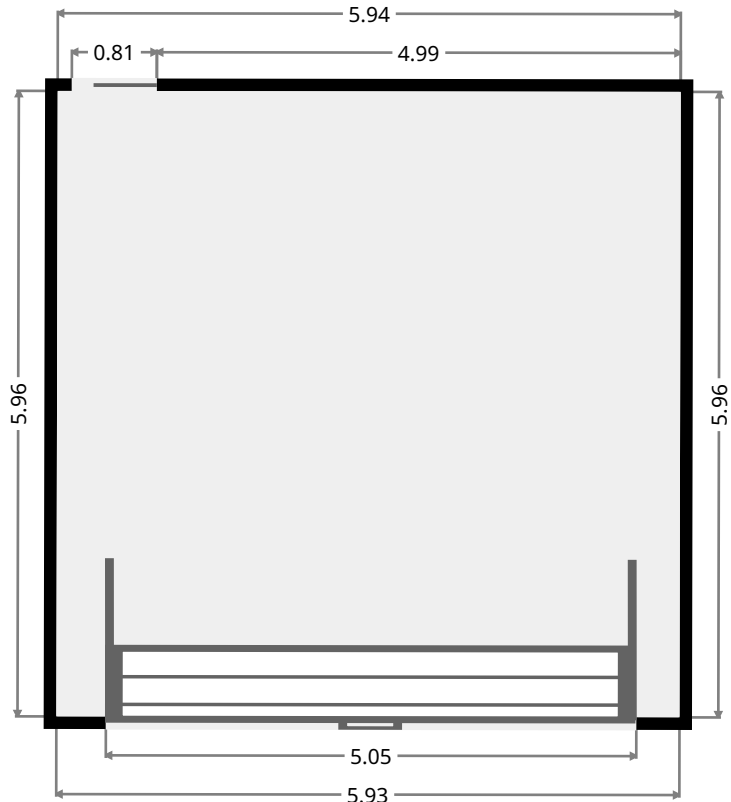
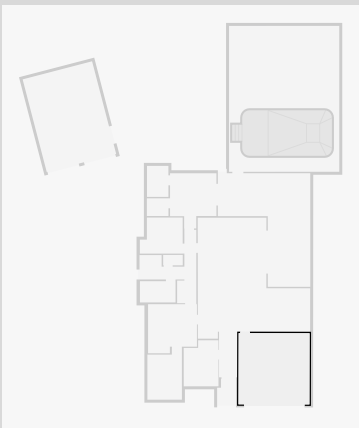

THIS FLOORPLAN IS PROVIDED WITHOUT WARRANTY OF ANY KIND. SENSOPIA DISCLAIMS ANY WARRANTY INCLUDING, WITHOUT LIMITATION, SATISFACTORY QUALITY OR ACCURACY OF DIMENSIONS.

# 5 Frangipani Court

## Kitchen/Living/Dining

Width: 9.40 m  
 Length: 10.11 m  
 Area: 68.94 m<sup>2</sup>  
 Perimeter: 39.02 m

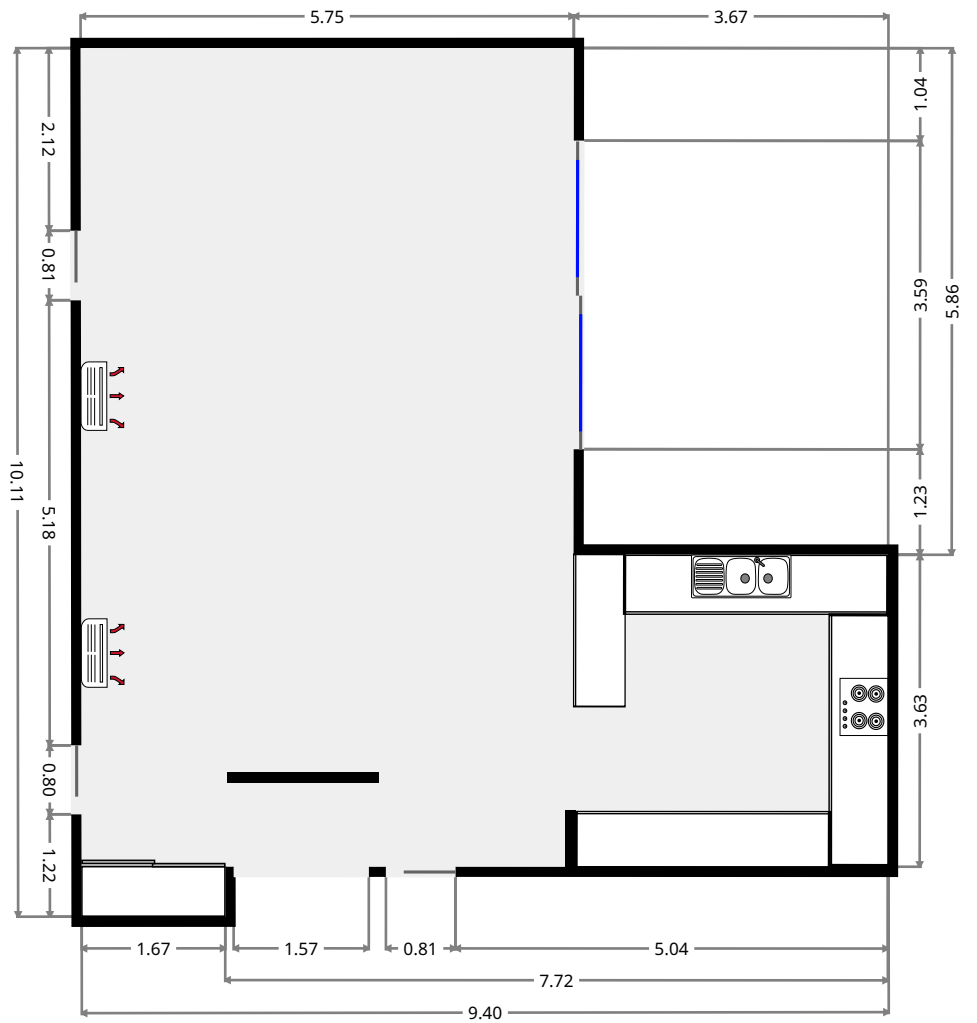
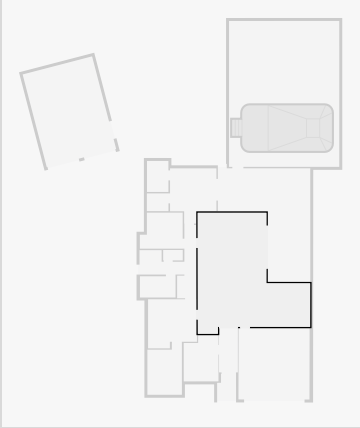

THIS FLOORPLAN IS PROVIDED WITHOUT WARRANTY OF ANY KIND. SENSOPIA DISCLAIMS ANY WARRANTY INCLUDING, WITHOUT LIMITATION, SATISFACTORY QUALITY OR ACCURACY OF DIMENSIONS.



# 5 Frangipani Court

## Bedroom

Width: 2.90 m  
Length: 3.84 m  
Area: 10.40 m<sup>2</sup>  
Perimeter: 13.50 m

