

5 Coral Close

SUBMITTED BY

Ray White Rockhampton Casey
stockers@cqoz.com

CREATED ON

2022-08-03

Floors

2

▼ Ground Floor

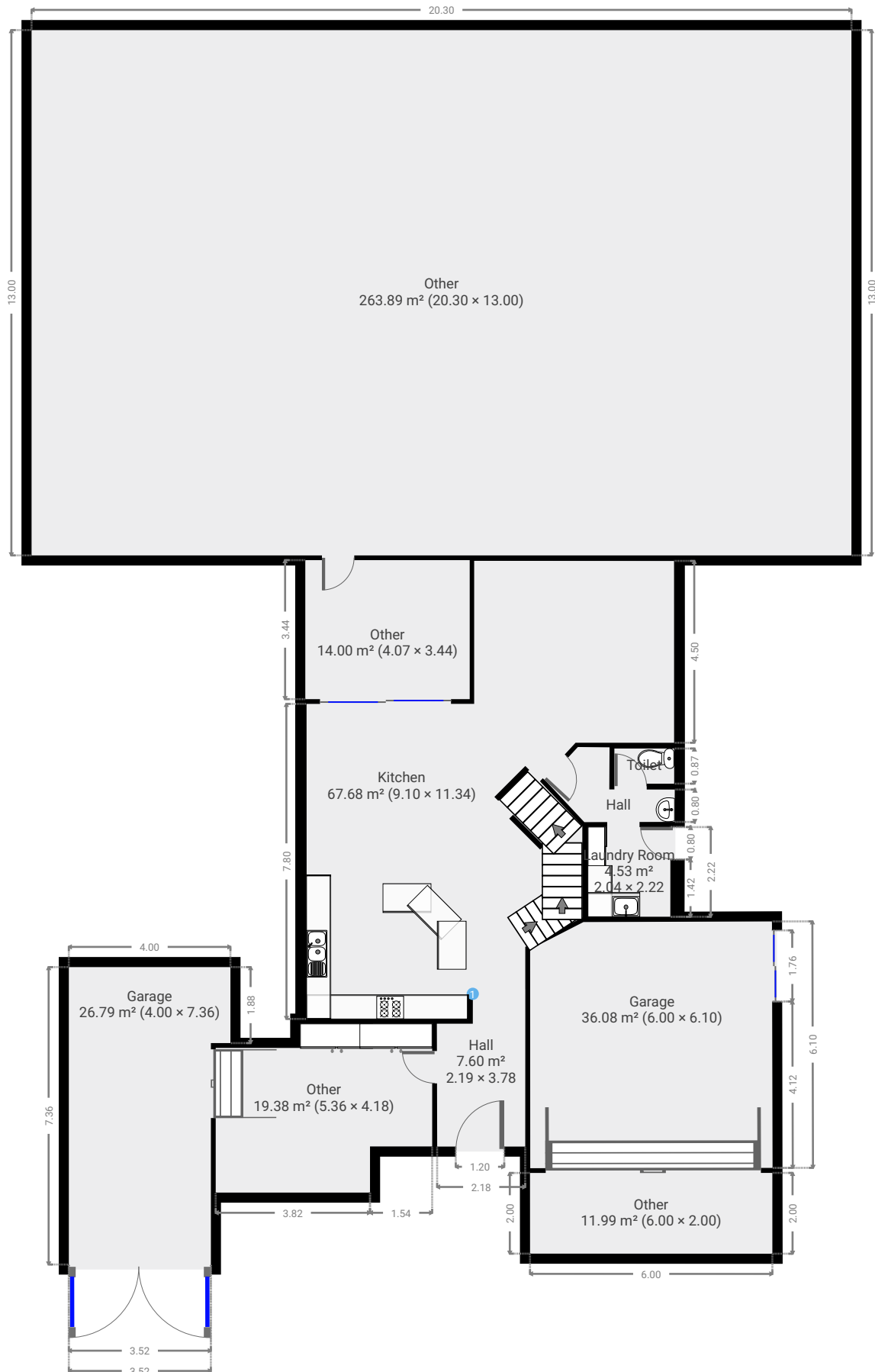

5 Coral Close

FLOORS: 2

▼ Garage Ground Floor

WIDTH: 6.00 m • LENGTH: 6.10 m
AREA: 36.08 m² • PERIMETER: 23.67 m

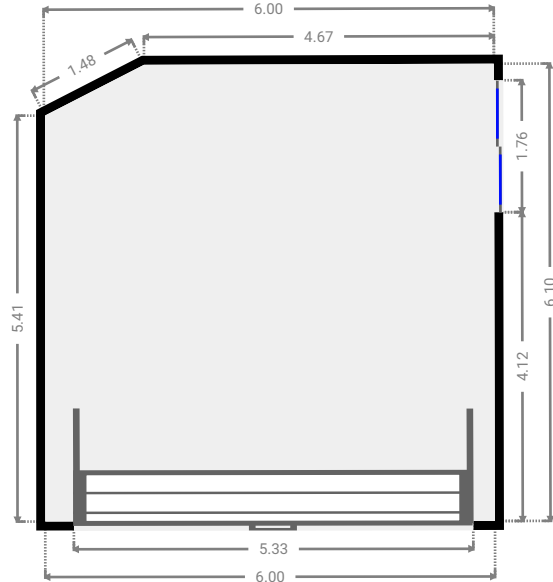
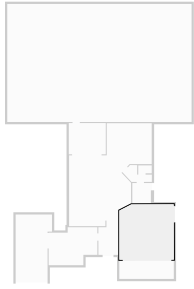

▼ Garage Ground Floor

WIDTH: 4.00 m • LENGTH: 7.36 m
AREA: 26.79 m² • PERIMETER: 22.72 m

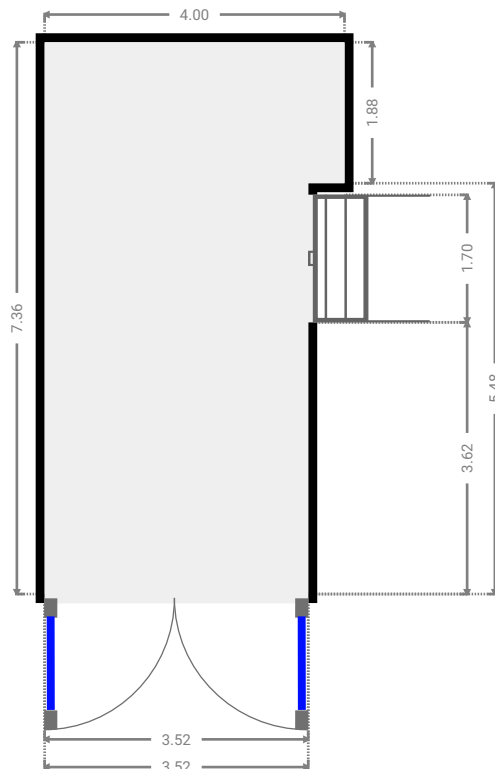
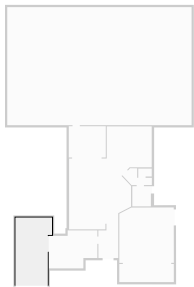

5 Coral Close

FLOORS: 2

▼ Hall Ground Floor

WIDTH: 2.19 m • LENGTH: 3.78 m
AREA: 7.60 m² • PERIMETER: 11.93 m

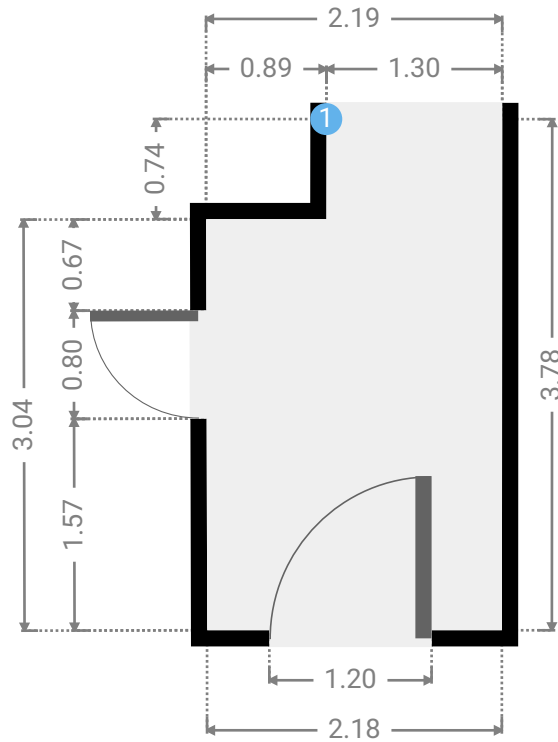
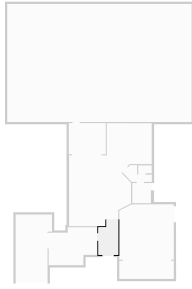

▼ Hall/Ground Floor

1 OPENING

Height
0.00 m



5 Coral Close

FLOORS: 2

▼ Laundry Room Ground Floor

WIDTH: 2.04 m • LENGTH: 2.22 m
AREA: 4.53 m² • PERIMETER: 8.52 m

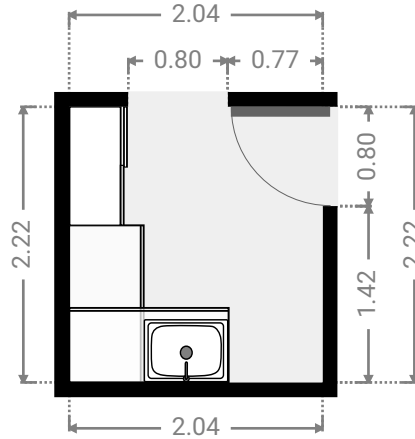
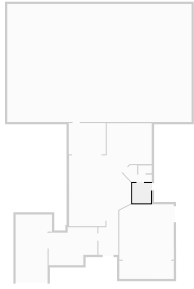

▼ Other Ground Floor

WIDTH: 5.36 m • LENGTH: 4.18 m
AREA: 19.38 m² • PERIMETER: 19.08 m

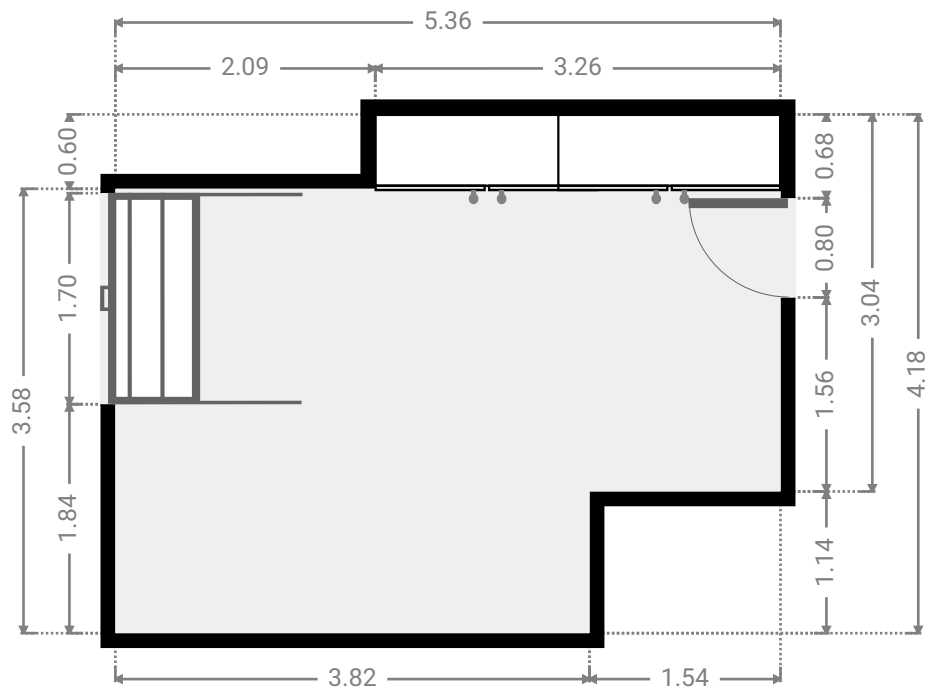
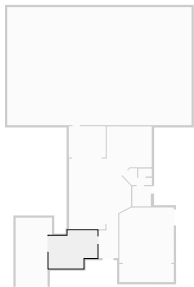

5 Coral Close

FLOORS: 2

▼ Other Ground Floor

WIDTH: 4.07 m • LENGTH: 3.44 m
AREA: 14.00 m² • PERIMETER: 15.02 m

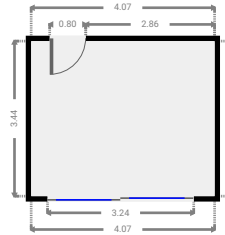
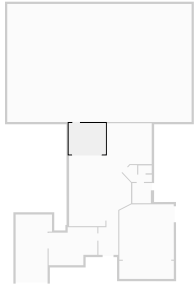

▼ Other Ground Floor

WIDTH: 20.30 m • LENGTH: 13.00 m
AREA: 263.89 m² • PERIMETER: 66.60 m

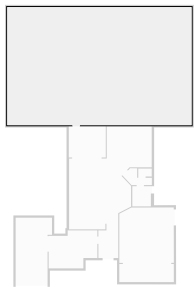

5 Coral Close

FLOORS: 2

▼ Other Ground Floor

WIDTH: 6.00 m • LENGTH: 2.00 m
AREA: 11.99 m² • PERIMETER: 16.00 m

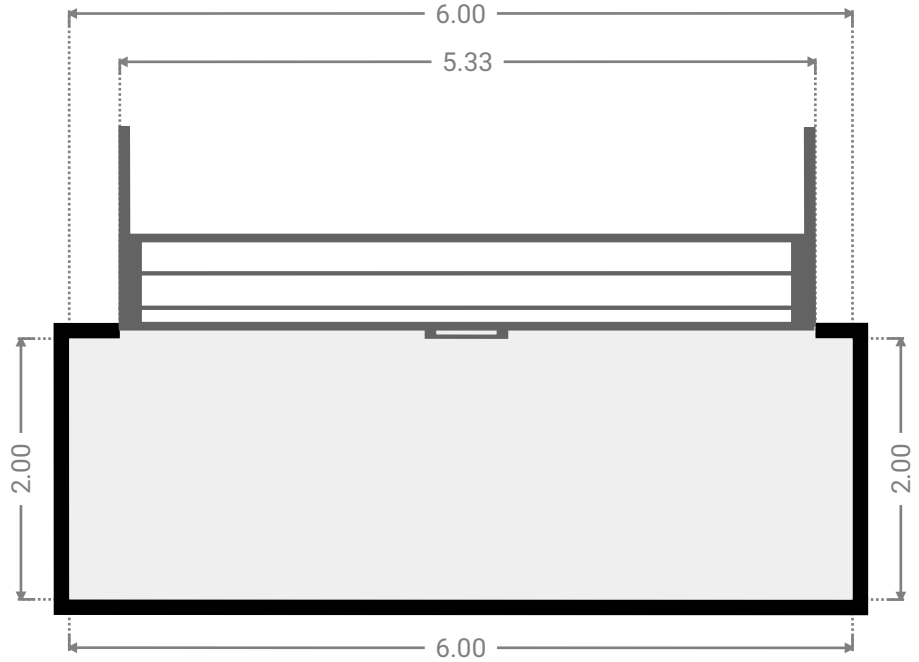
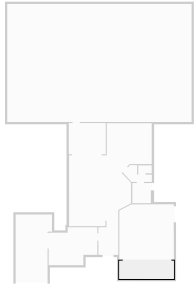

▼ Toilet Ground Floor

WIDTH: 1.48 m • LENGTH: 0.87 m
AREA: 1.29 m² • PERIMETER: 4.70 m

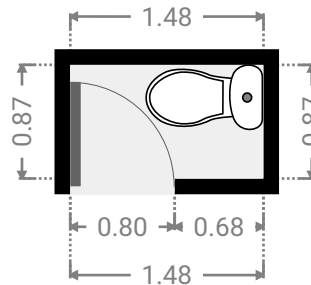
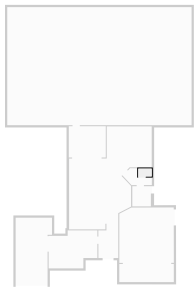

5 Coral Close

FLOORS: 2

▼ 1st Floor

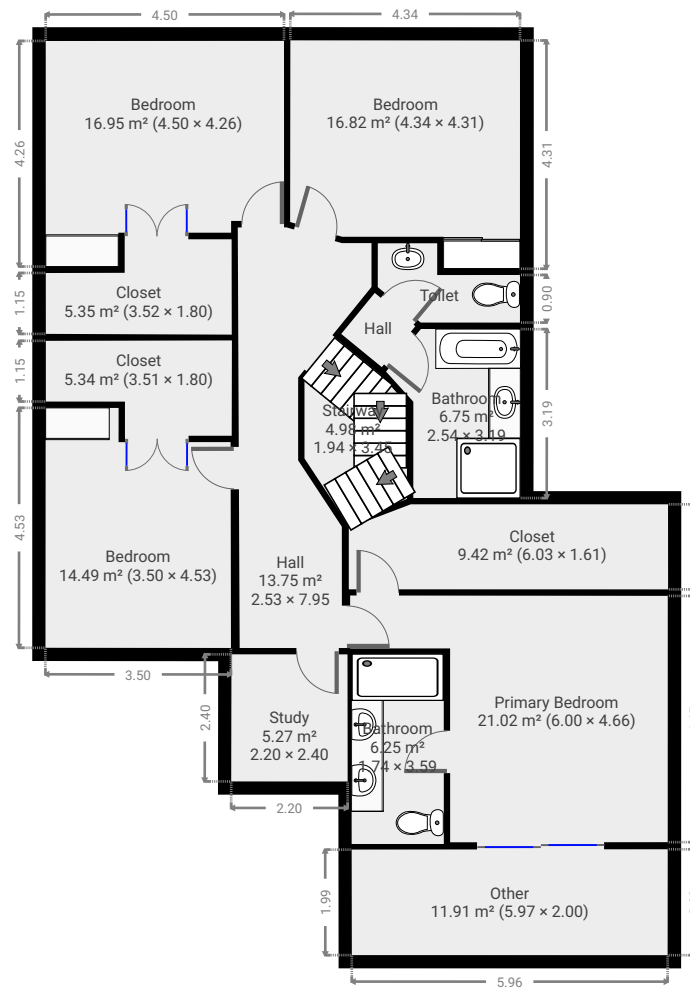

▼ **Bathroom**
1st Floor

WIDTH: 2.54 m • LENGTH: 3.19 m
AREA: 6.75 m² • PERIMETER: 10.71 m

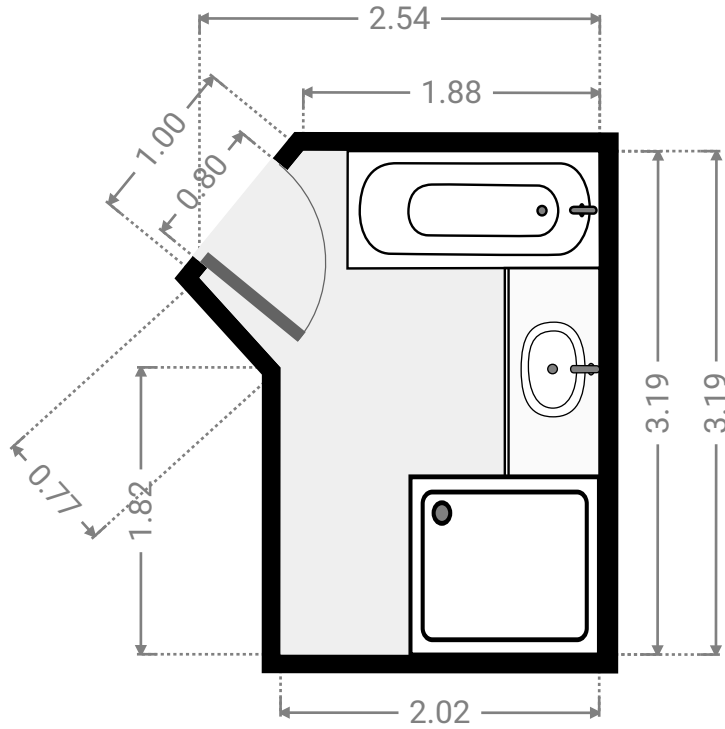
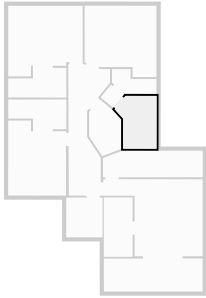

▼ **Bathroom**
1st Floor

WIDTH: 1.74 m • LENGTH: 3.59 m
AREA: 6.25 m² • PERIMETER: 10.66 m

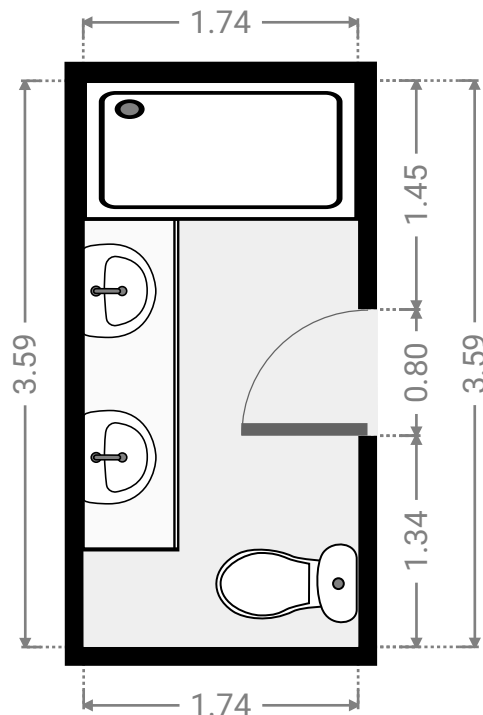
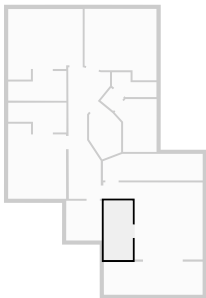

▼ **Bedroom**
1st Floor

WIDTH: 4.34 m • LENGTH: 4.31 m
AREA: 16.82 m² • PERIMETER: 17.06 m

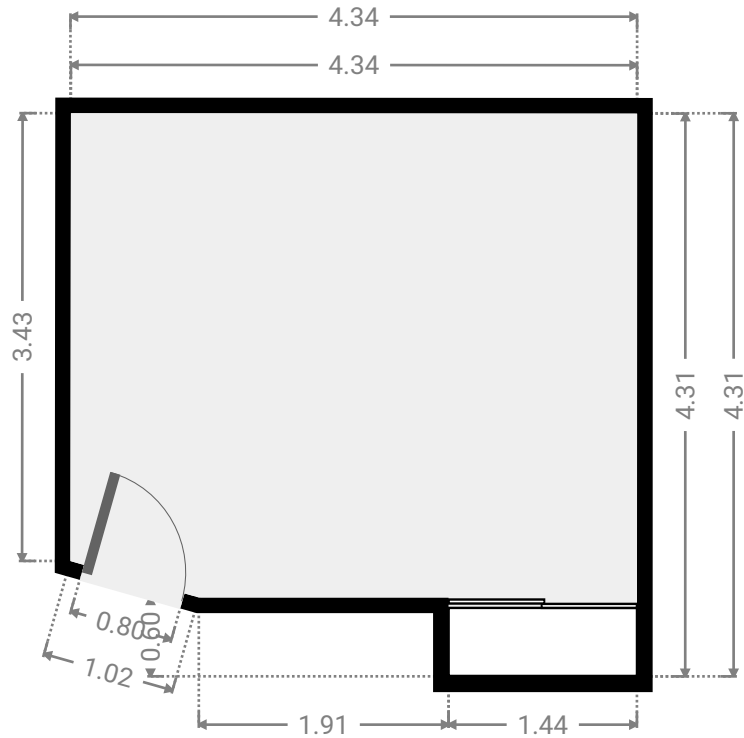
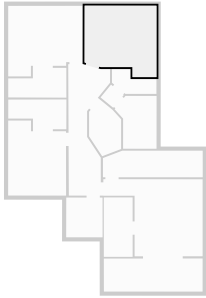

▼ **Bedroom**
1st Floor

WIDTH: 4.50 m • LENGTH: 4.26 m
AREA: 16.95 m² • PERIMETER: 17.52 m

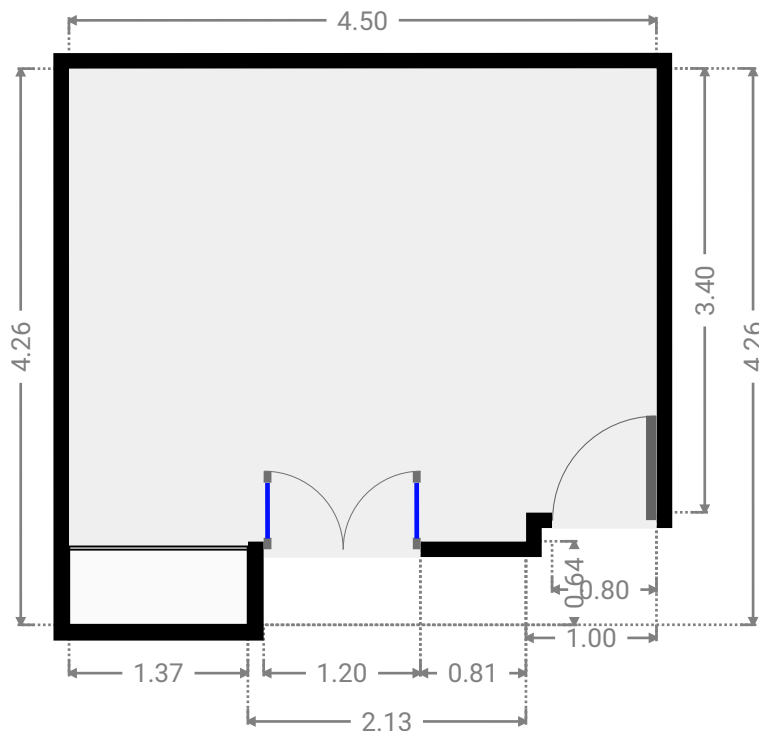
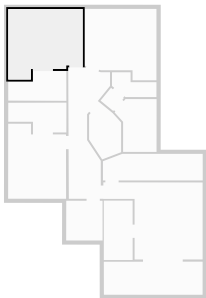

▼ Closet
1st Floor

WIDTH: 3.52 m • LENGTH: 1.80 m
AREA: 5.35 m² • PERIMETER: 10.60 m

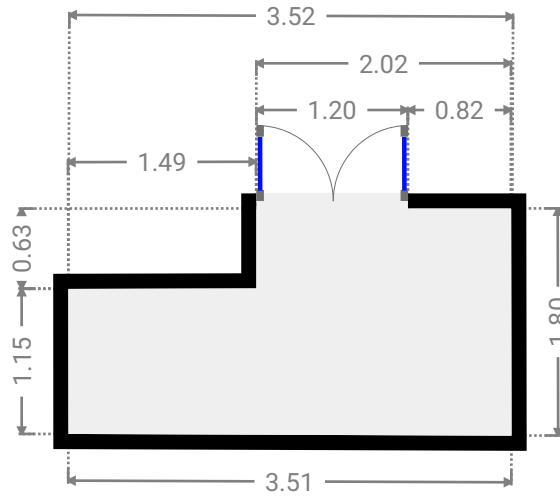
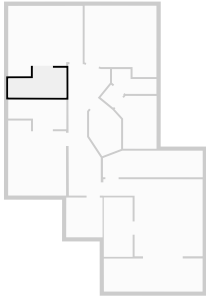

▼ Bedroom
1st Floor

WIDTH: 3.50 m • LENGTH: 4.53 m
AREA: 14.49 m² • PERIMETER: 16.06 m

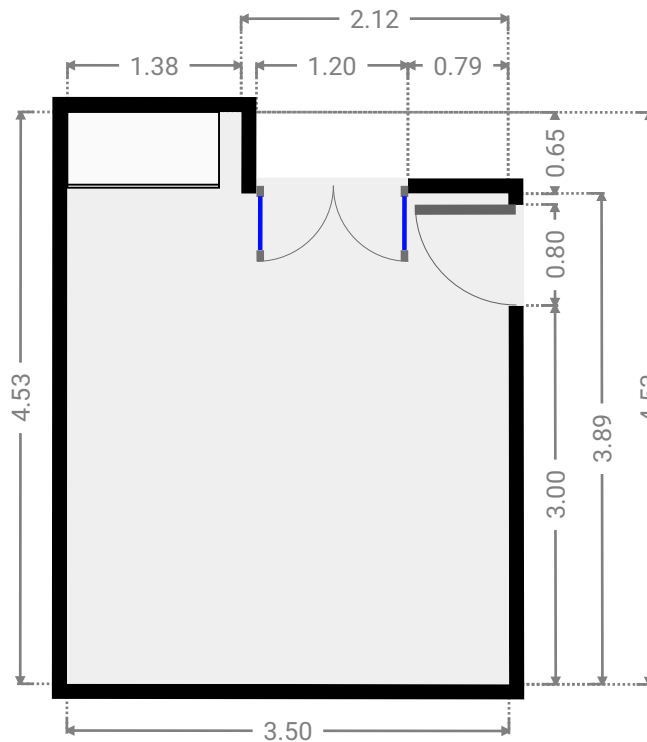
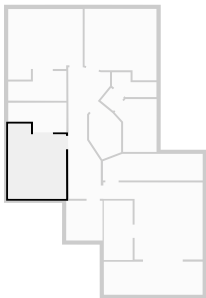

▼ Closet 1st Floor

WIDTH: 3.51 m • LENGTH: 1.80 m
AREA: 5.34 m² • PERIMETER: 10.61 m

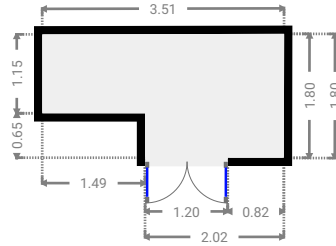
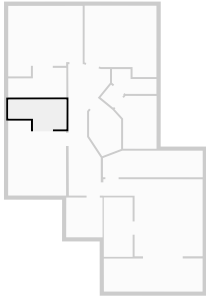

▼ Hall 1st Floor

WIDTH: 2.53 m • LENGTH: 7.95 m
AREA: 13.75 m² • PERIMETER: 20.82 m

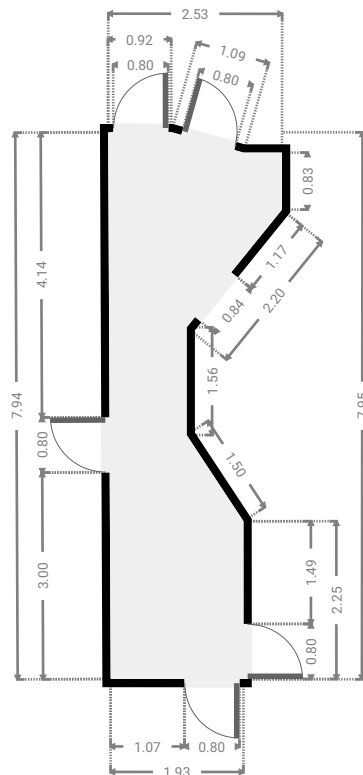
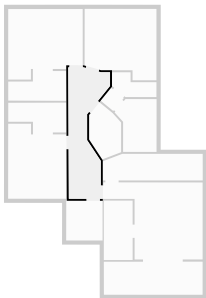

5 Coral Close

FLOORS: 2

▼ Hall 1st Floor

WIDTH: 0.99 m • LENGTH: 1.00 m
AREA: 0.99 m² • PERIMETER: 3.98 m

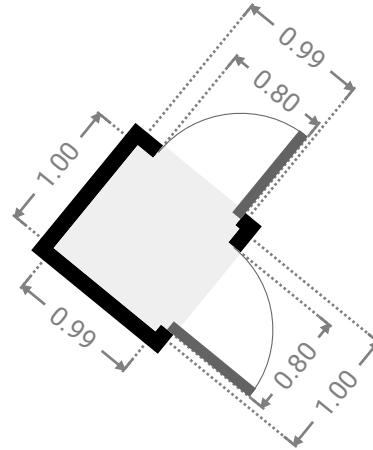
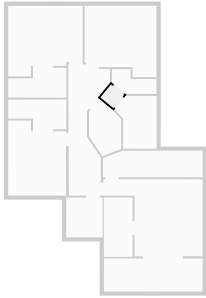

▼ Other 1st Floor

WIDTH: 5.97 m • LENGTH: 2.00 m
AREA: 11.91 m² • PERIMETER: 15.93 m

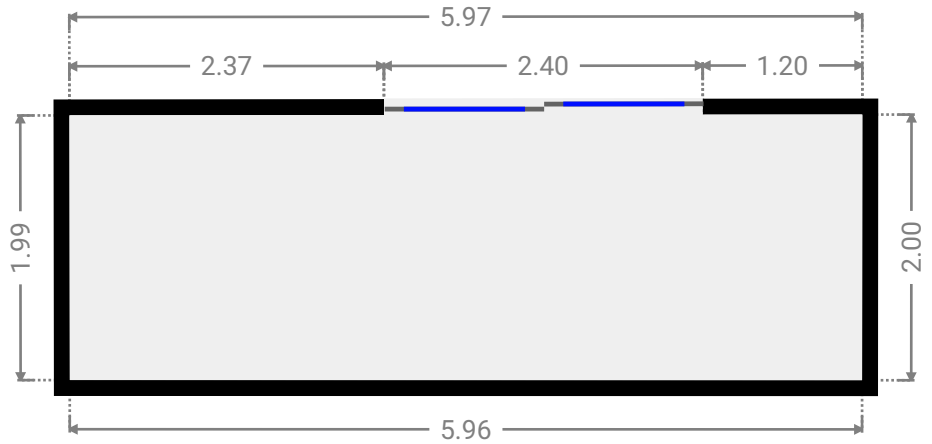
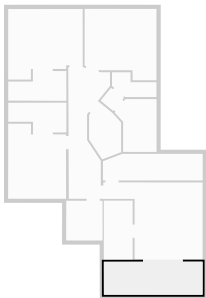

5 Coral Close

FLOORS: 2

▼ Primary Bedroom 1st Floor

WIDTH: 6.00 m • LENGTH: 4.66 m
AREA: 21.02 m² • PERIMETER: 21.31 m

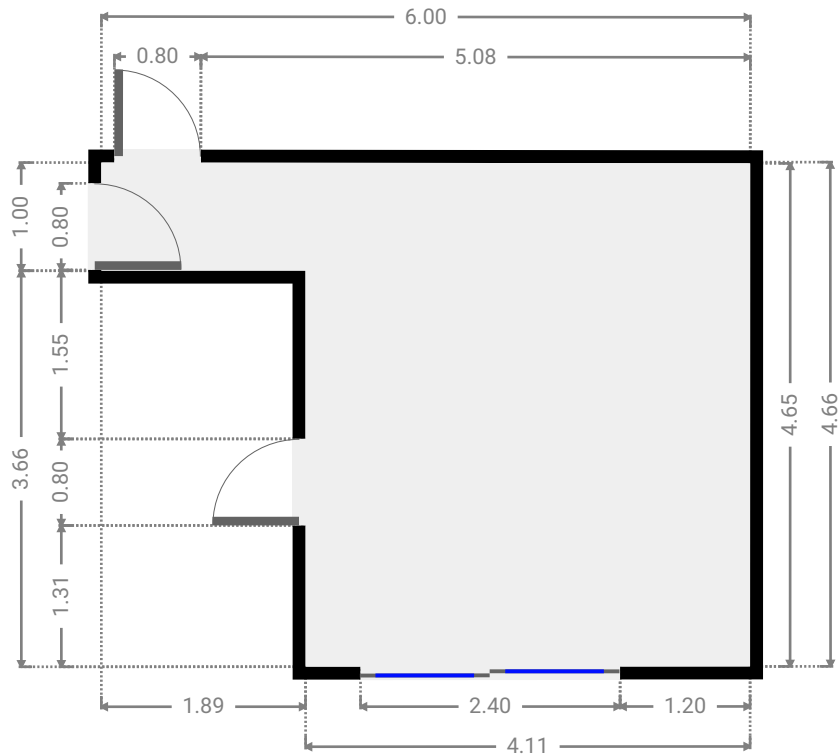
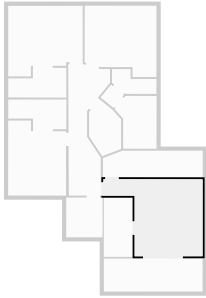

▼ Closet 1st Floor

WIDTH: 6.03 m • LENGTH: 1.61 m
AREA: 9.42 m² • PERIMETER: 14.91 m

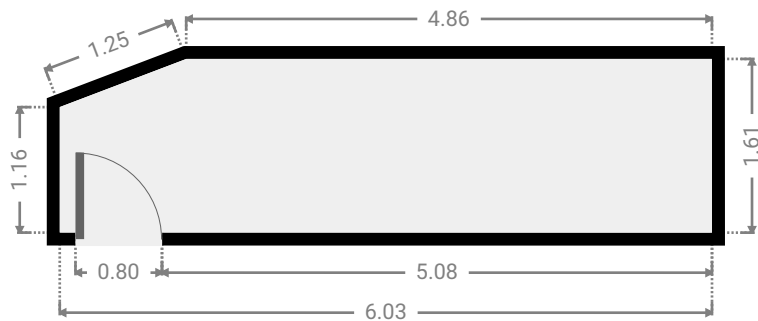
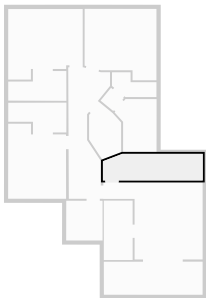

5 Coral Close

FLOORS: 2

▼ Stairway 1st Floor

WIDTH: 1.94 m • LENGTH: 3.45 m
AREA: 4.98 m² • PERIMETER: 8.73 m

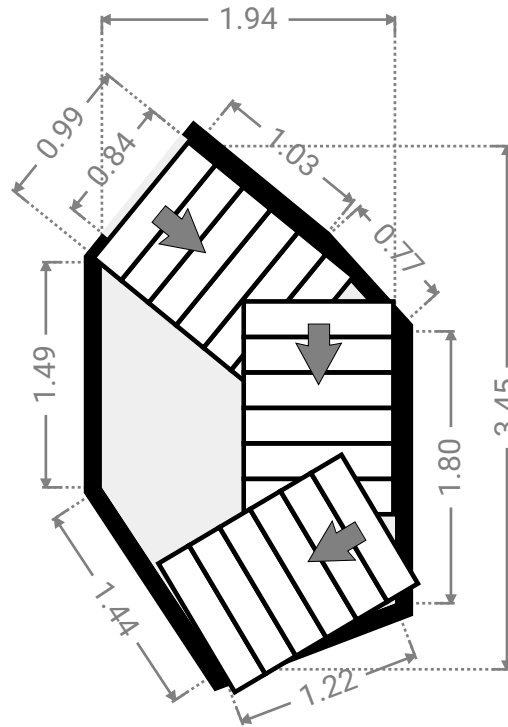
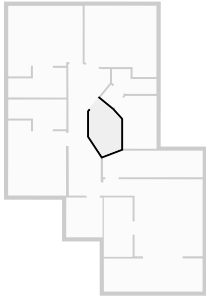

▼ Study 1st Floor

WIDTH: 2.20 m • LENGTH: 2.40 m
AREA: 5.27 m² • PERIMETER: 9.19 m

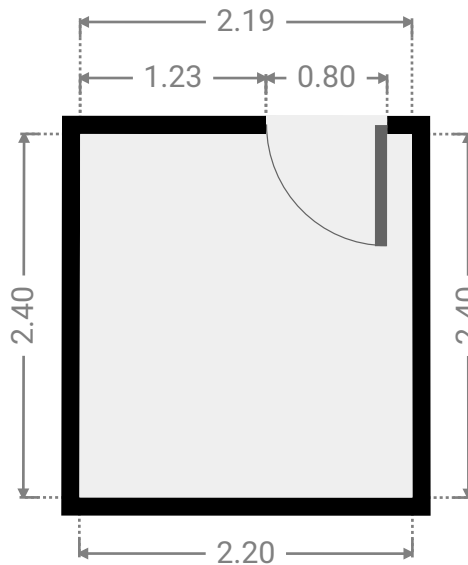
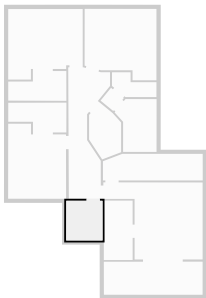

5 Coral Close

FLOORS: 2

▼ Toilet 1st Floor

WIDTH: 2.69 m • LENGTH: 1.50 m
AREA: 2.81 m² • PERIMETER: 7.94 m

