

# 5 Carol Court

## Ground Floor

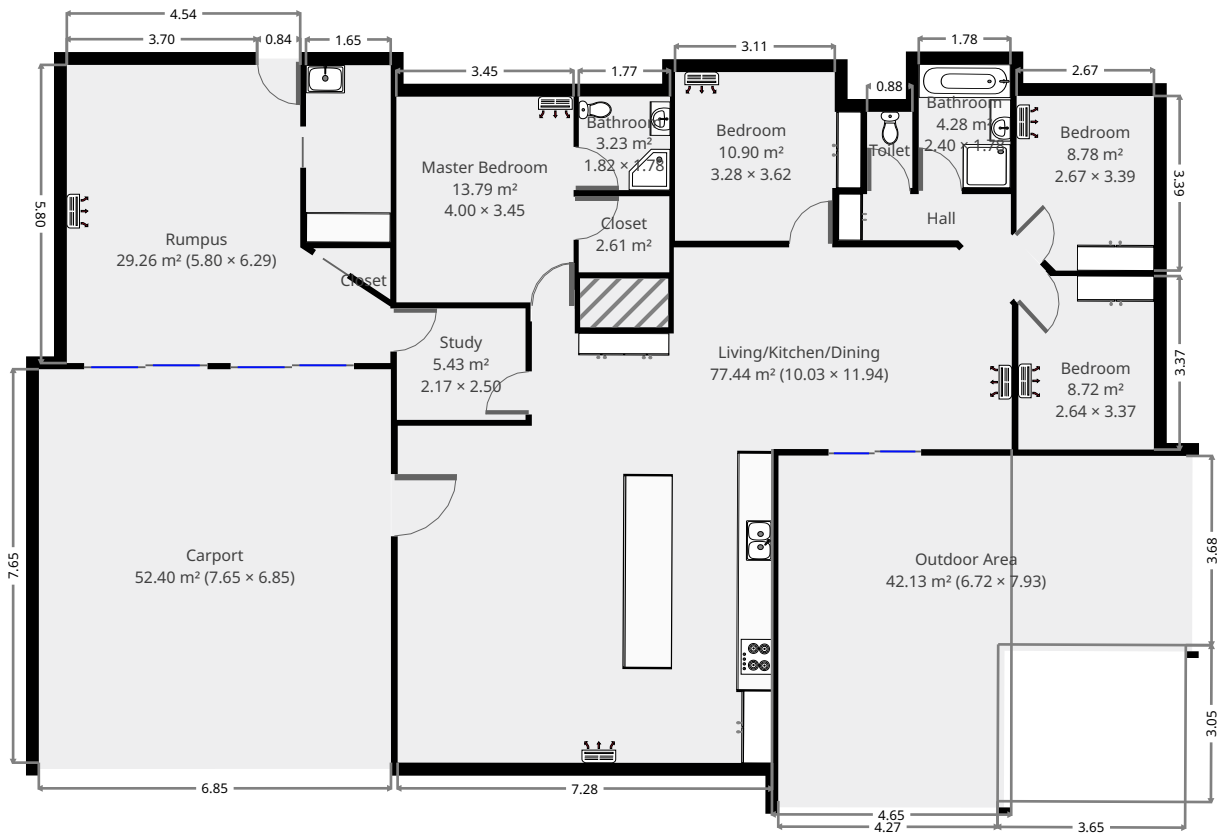

THIS FLOORPLAN IS PROVIDED WITHOUT WARRANTY OF ANY KIND. SENSOPIA DISCLAIMS ANY WARRANTY INCLUDING, WITHOUT LIMITATION, SATISFACTORY QUALITY OR ACCURACY OF DIMENSIONS.

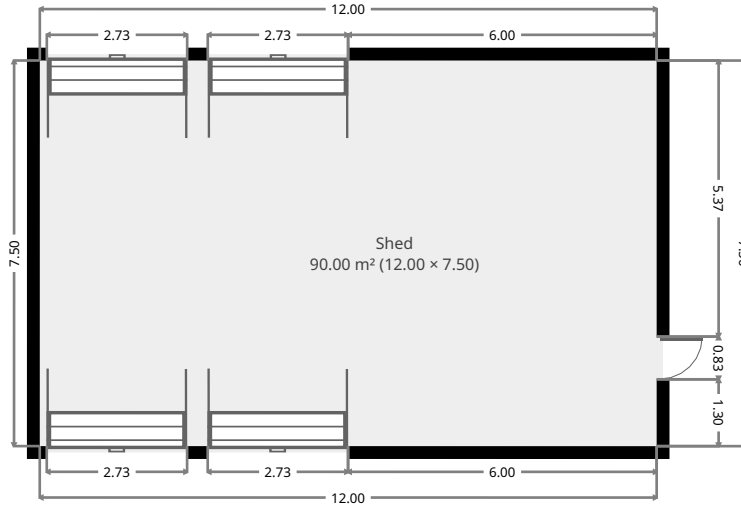

# 5 Carol Court

## Bedroom

Width: 3.28 m  
 Length: 3.62 m  
 Area: 10.90 m<sup>2</sup>  
 Perimeter: 13.79 m

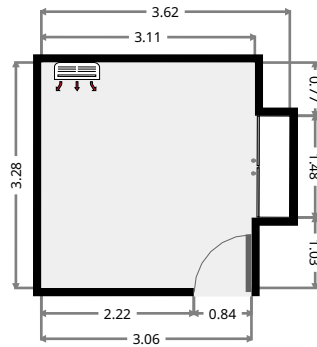
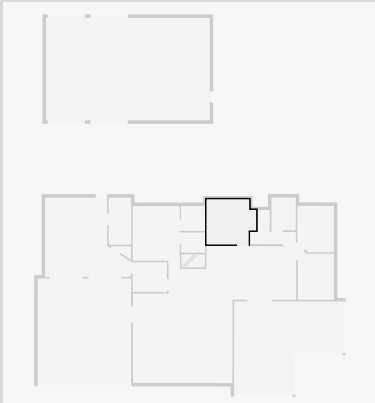

## Shed

Width: 7.50 m  
 Length: 12.00 m  
 Area: 90.00 m<sup>2</sup>  
 Perimeter: 39.00 m

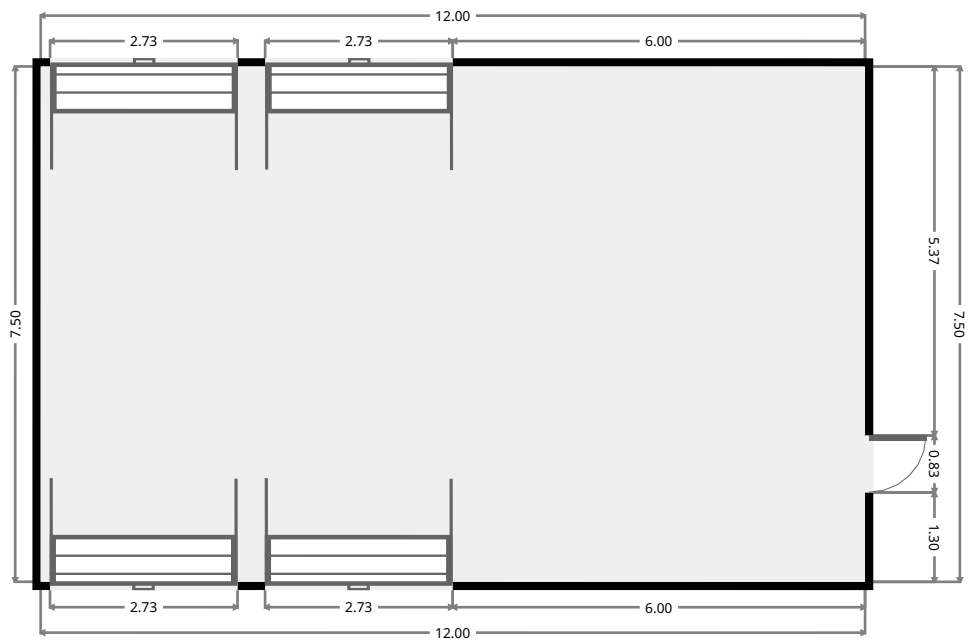
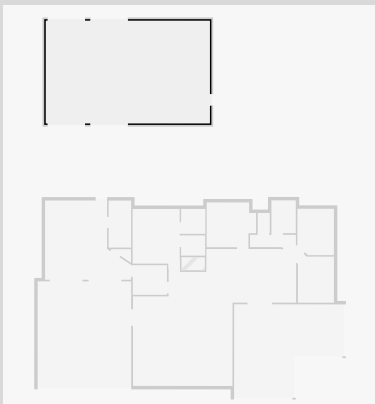

THIS FLOORPLAN IS PROVIDED WITHOUT WARRANTY OF ANY KIND. SENSOPIA DISCLAIMS ANY WARRANTY INCLUDING, WITHOUT LIMITATION, SATISFACTORY QUALITY OR ACCURACY OF DIMENSIONS.

# 5 Carol Court

## Carport

Width: 6.85 m  
Length: 7.65 m  
Area: 52.40 m<sup>2</sup>  
Perimeter: 29.00 m

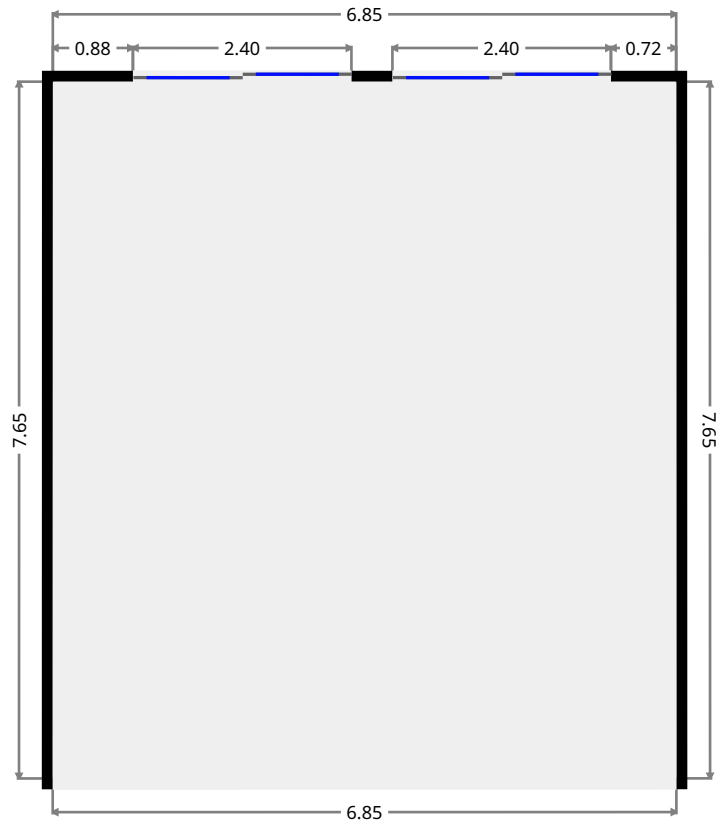
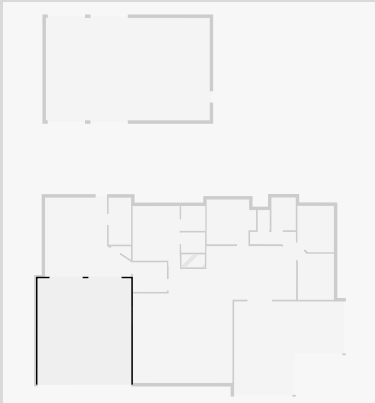

## Outdoor Area

Width: 6.72 m  
Length: 7.93 m  
Area: 42.13 m<sup>2</sup>  
Perimeter: 29.29 m

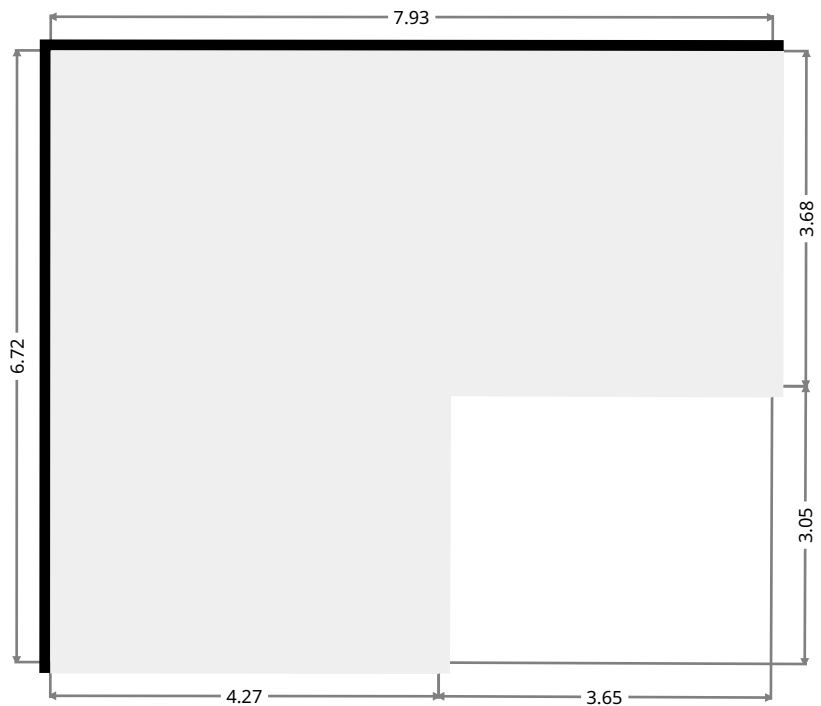
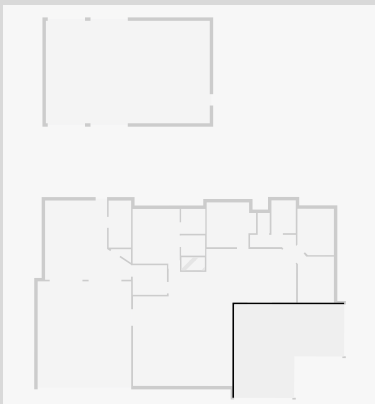

# 5 Carol Court

## Bedroom

Width: 2.64 m  
 Length: 3.37 m  
 Area: 8.72 m<sup>2</sup>  
 Perimeter: 11.68 m

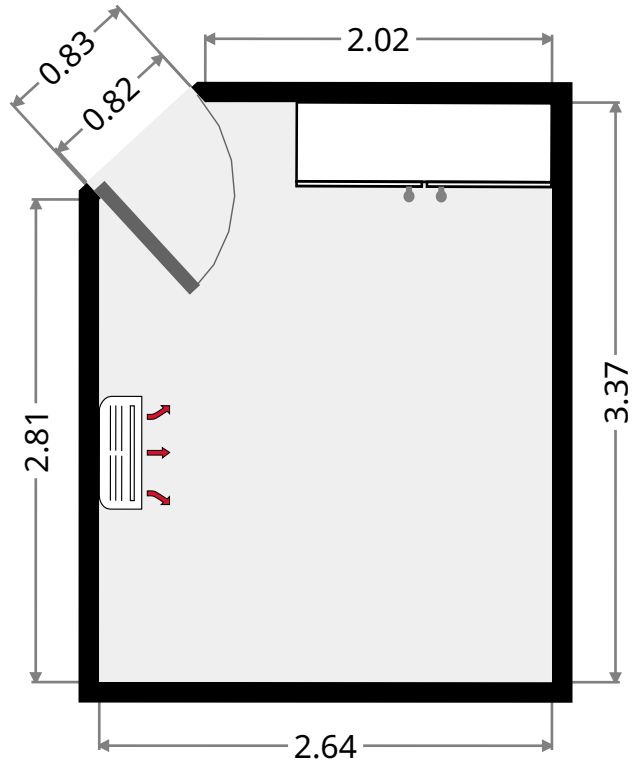
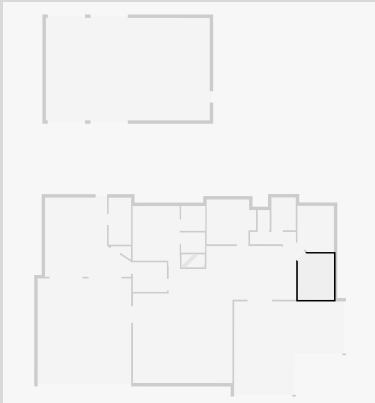

## Bedroom

Width: 2.67 m  
 Length: 3.39 m  
 Area: 8.78 m<sup>2</sup>  
 Perimeter: 11.69 m

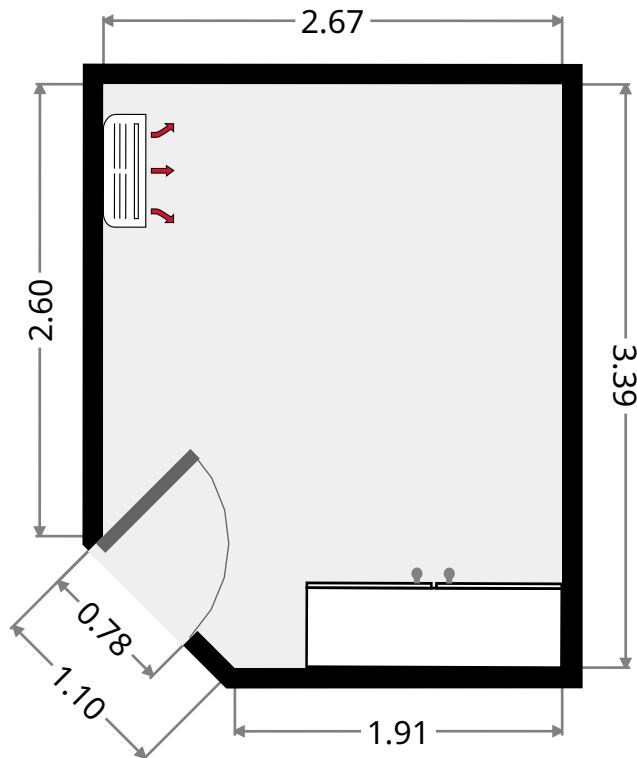
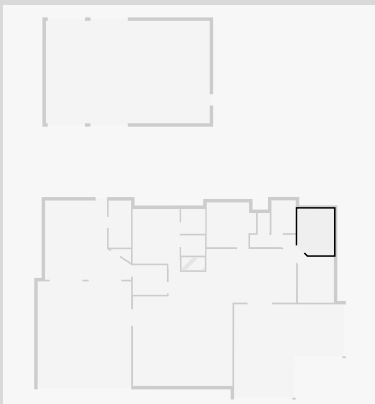

THIS FLOORPLAN IS PROVIDED WITHOUT WARRANTY OF ANY KIND. SENSOPIA DISCLAIMS ANY WARRANTY INCLUDING, WITHOUT LIMITATION, SATISFACTORY QUALITY OR ACCURACY OF DIMENSIONS.

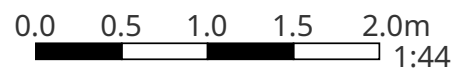

# 5 Carol Court

## Bathroom

Width: 1.78 m  
Length: 2.40 m  
Area: 4.28 m<sup>2</sup>  
Perimeter: 8.37 m

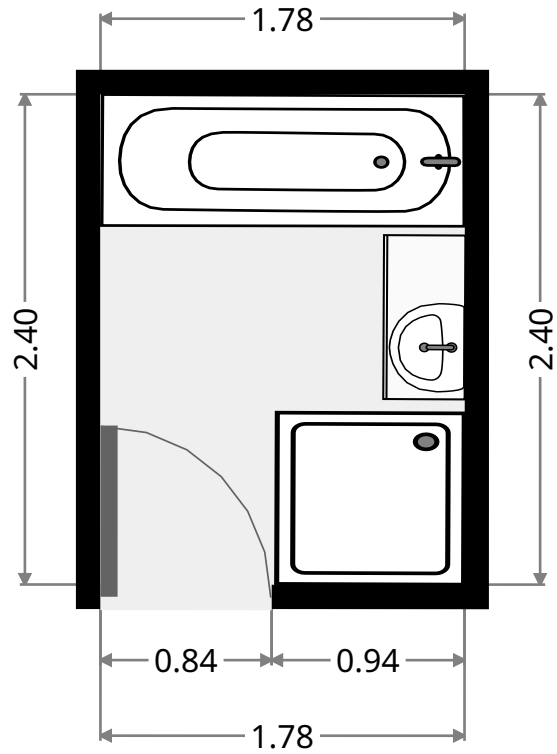
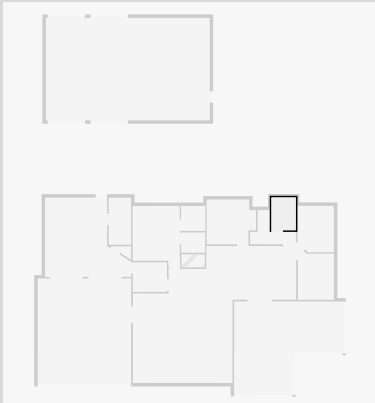

## Toilet

Width: 0.88 m  
Length: 1.48 m  
Area: 1.30 m<sup>2</sup>  
Perimeter: 4.72 m

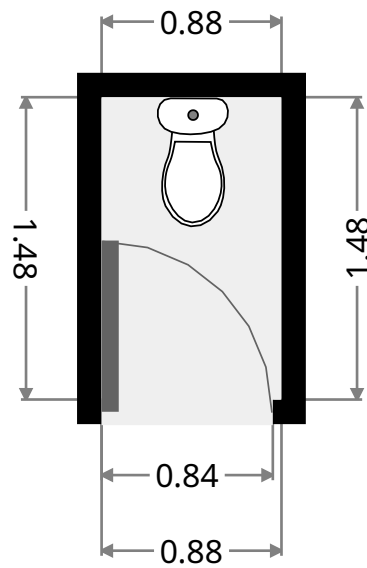
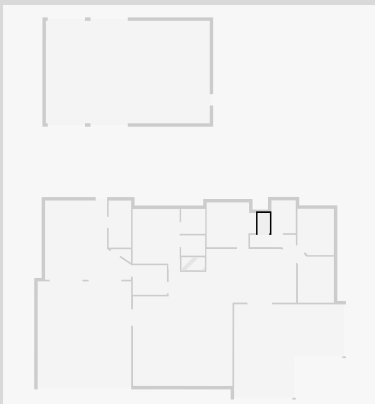

# 5 Carol Court

## Hall

Width: 0.89 m  
 Length: 3.36 m  
 Area: 4.03 m<sup>2</sup>  
 Perimeter: 10.79 m

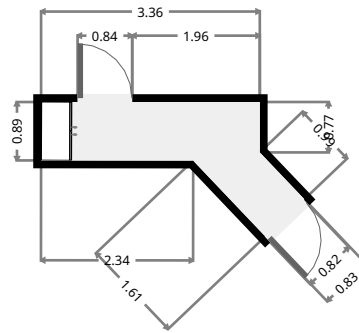
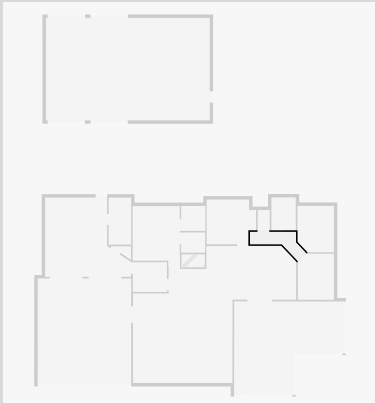

## Living/Kitchen/Dining

Width: 10.03 m  
 Length: 11.94 m  
 Area: 77.44 m<sup>2</sup>  
 Perimeter: 44.25 m

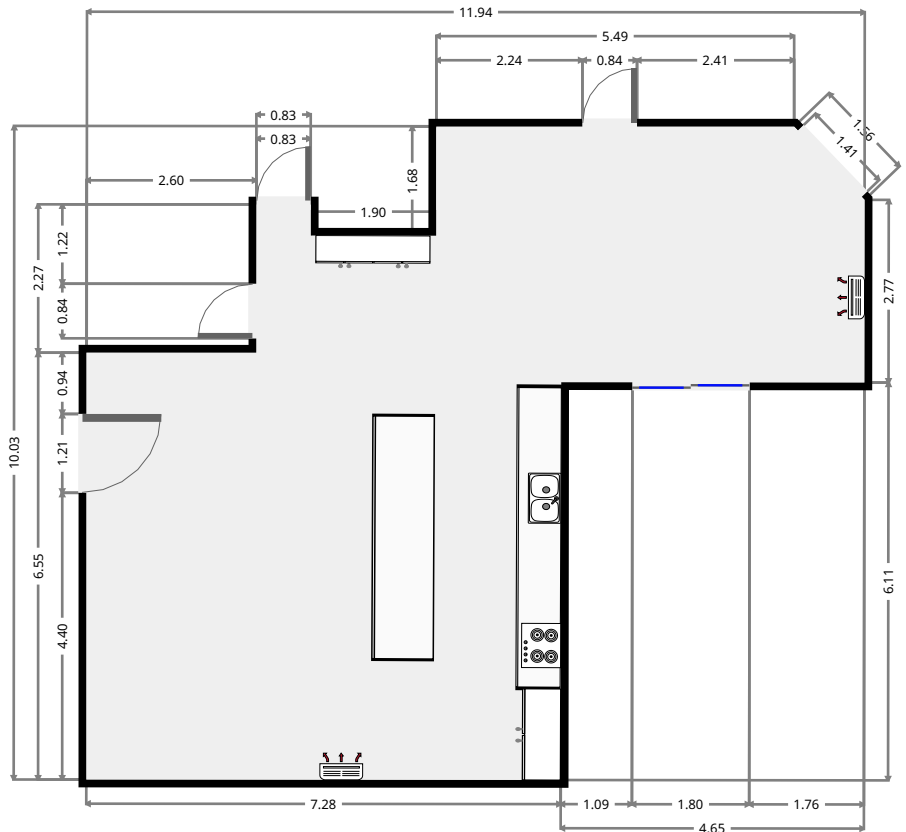
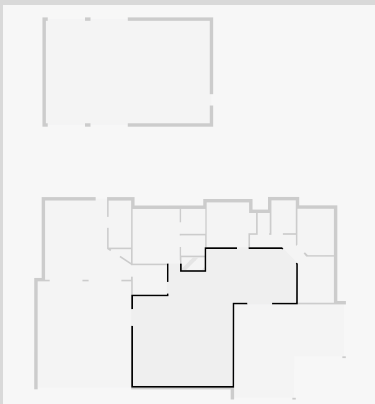

THIS FLOORPLAN IS PROVIDED WITHOUT WARRANTY OF ANY KIND. SENSOPIA DISCLAIMS ANY WARRANTY INCLUDING, WITHOUT LIMITATION, SATISFACTORY QUALITY OR ACCURACY OF DIMENSIONS.

# 5 Carol Court

## Closet

Width: 1.48 m  
Length: 1.77 m  
Area: 2.61 m<sup>2</sup>  
Perimeter: 6.48 m

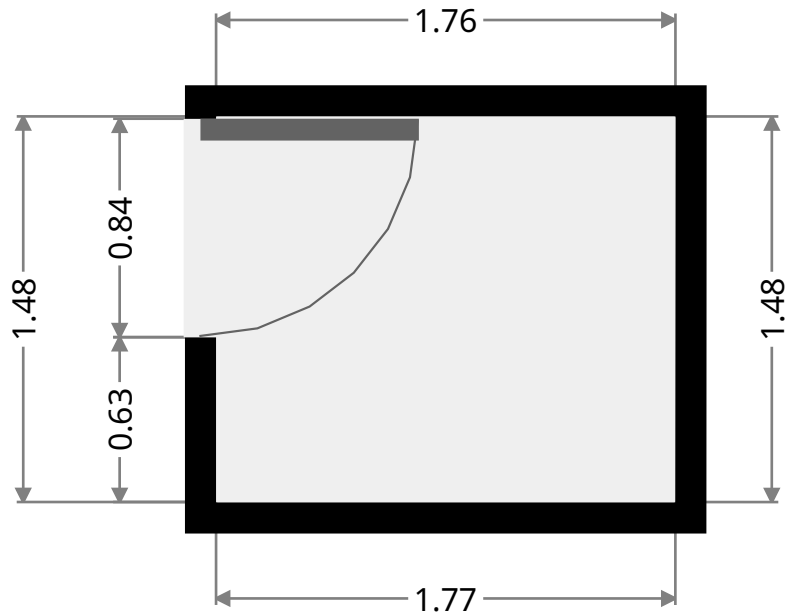
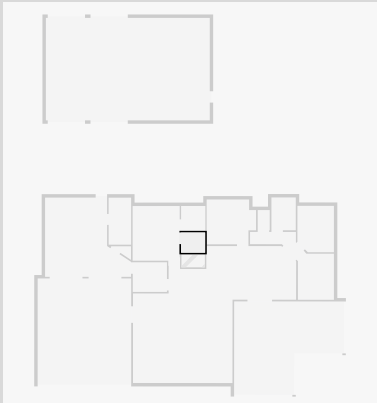

## Bathroom

Width: 1.78 m  
Length: 1.82 m  
Area: 3.23 m<sup>2</sup>  
Perimeter: 7.19 m

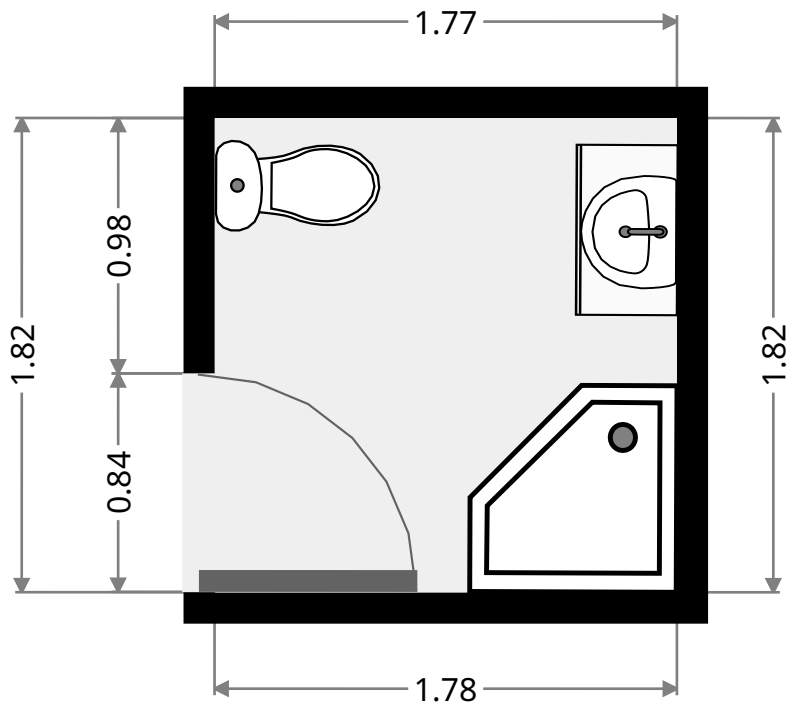
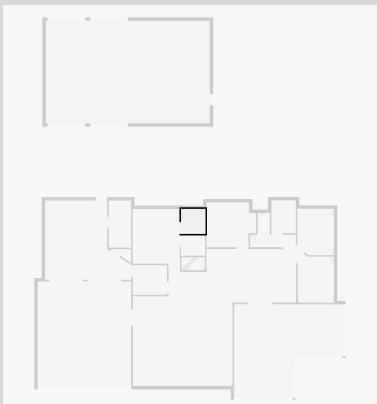

# 5 Carol Court

## Master Bedroom

Width: 3.45 m  
 Length: 4.00 m  
 Area: 13.79 m<sup>2</sup>  
 Perimeter: 14.90 m

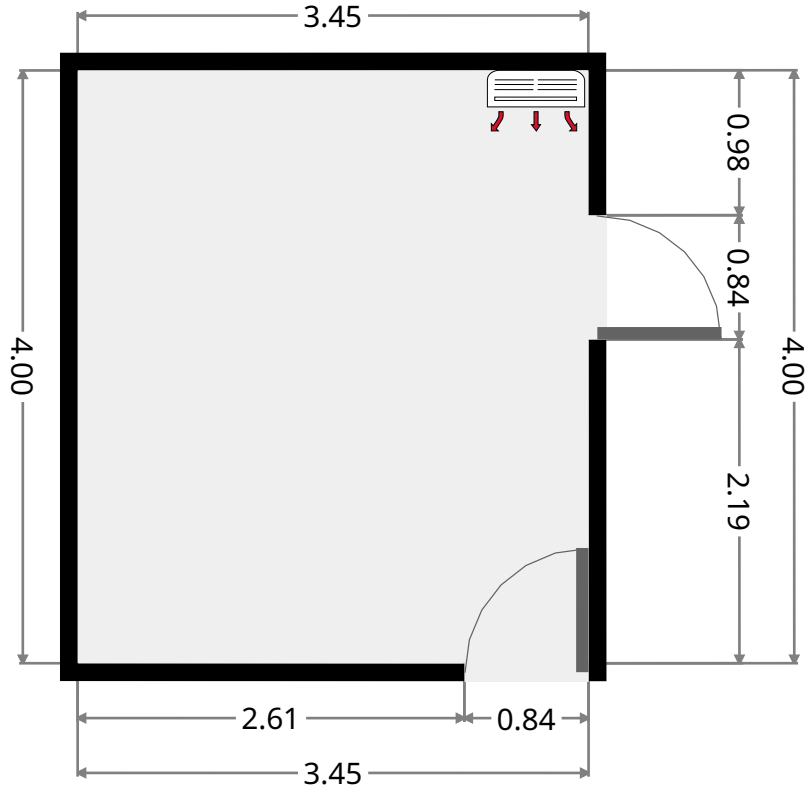
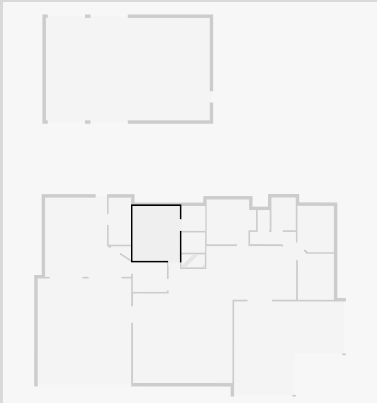

## Closet

Width: 0.00 m  
 Length: 1.80 m  
 Area: 0.75 m<sup>2</sup>  
 Perimeter: 4.29 m

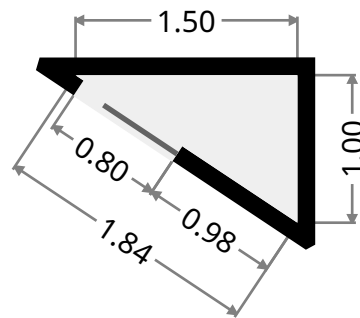
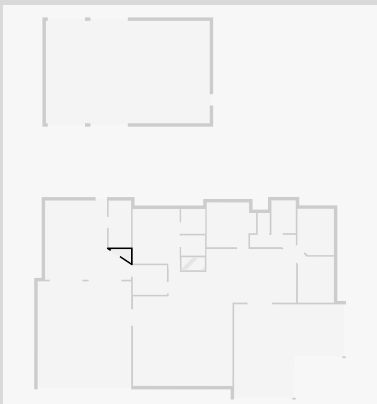



# 5 Carol Court

## Laundry Room

Width: 1.65 m  
 Length: 3.44 m  
 Area: 5.67 m<sup>2</sup>  
 Perimeter: 10.18 m

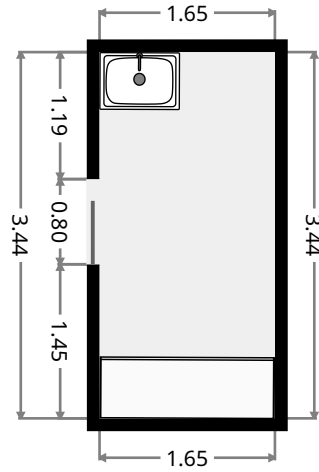
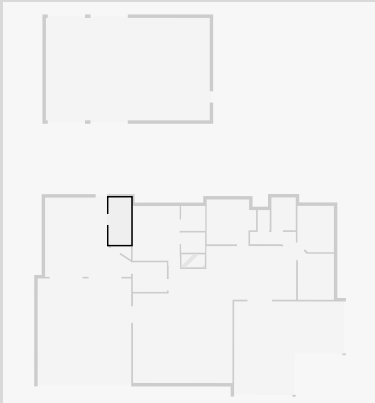

## Rumpus

Width: 5.80 m  
 Length: 6.29 m  
 Area: 29.26 m<sup>2</sup>  
 Perimeter: 23.38 m

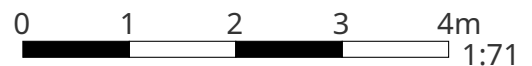
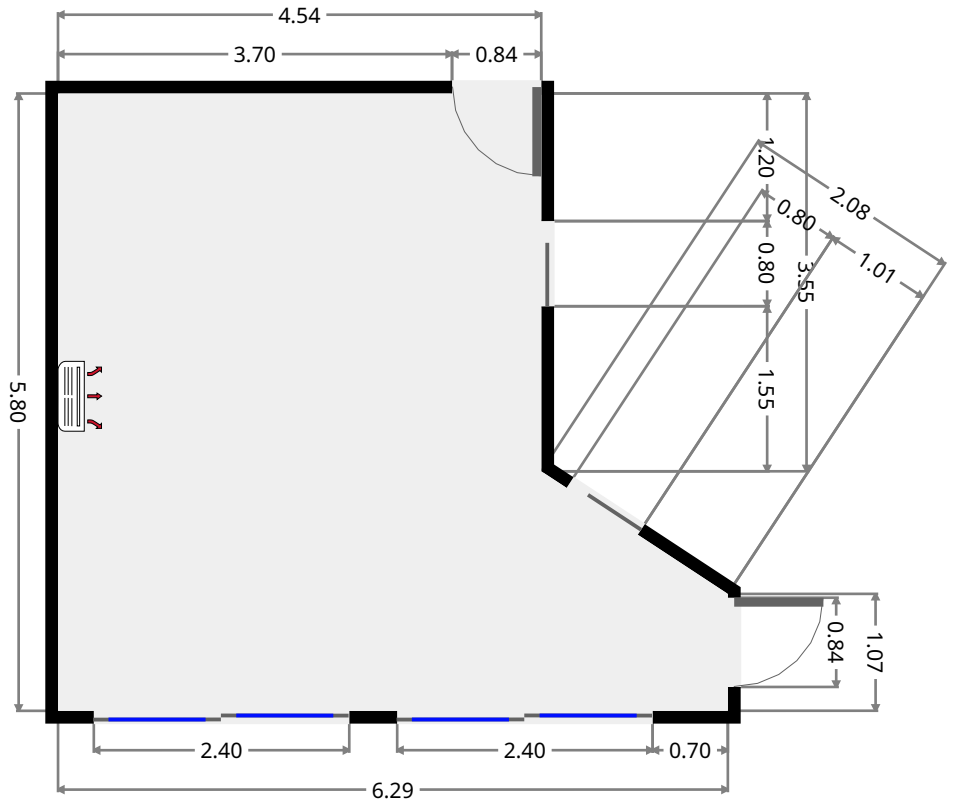
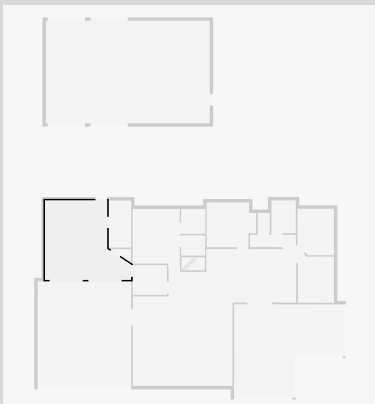

THIS FLOORPLAN IS PROVIDED WITHOUT WARRANTY OF ANY KIND. SENSOPIA DISCLAIMS ANY WARRANTY INCLUDING, WITHOUT LIMITATION, SATISFACTORY QUALITY OR ACCURACY OF DIMENSIONS.

# 5 Carol Court

## Study

Width: 2.17 m  
Length: 2.50 m  
Area: 5.43 m<sup>2</sup>  
Perimeter: 9.34 m

