

5 Benjamin Drive

Created on
2020-12-08

Floors 1

▼ Ground Floor

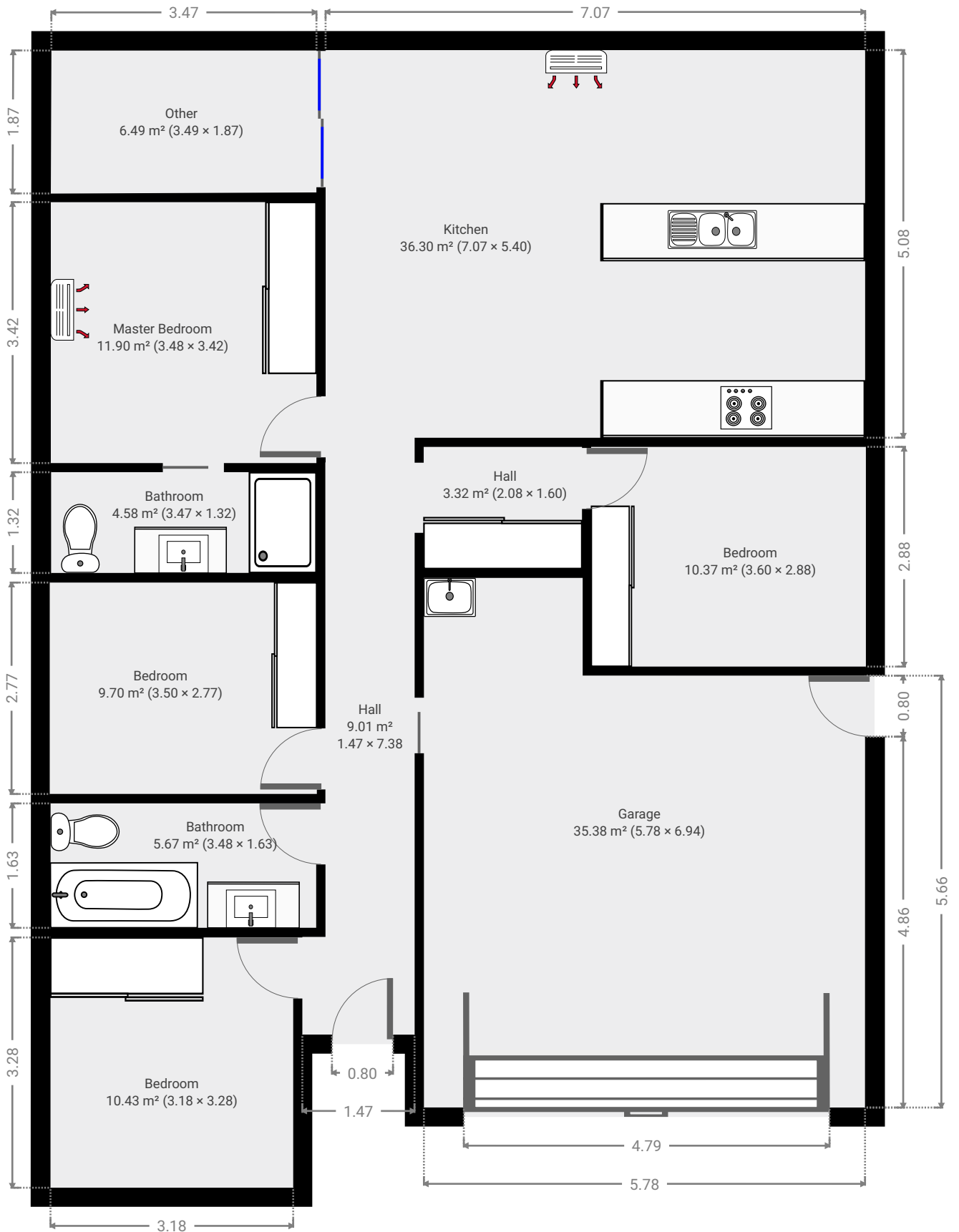

▼ **Hall**
Ground Floor

WIDTH:1.47 m · LENGTH:7.38 m
AREA:9.01 m² · PERIMETER:17.70 m

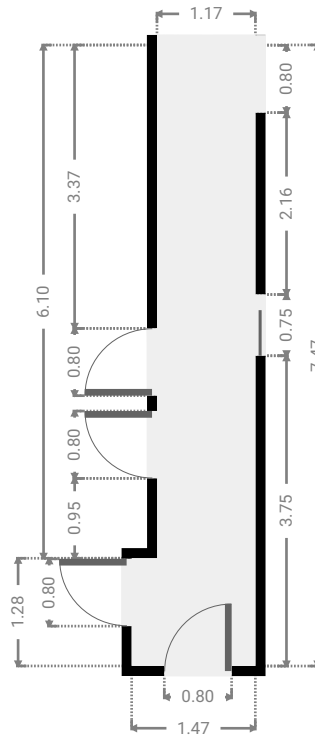
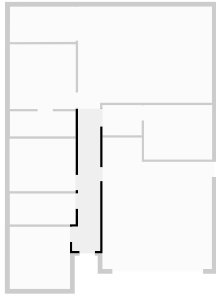

▼ **Bedroom**
Ground Floor

WIDTH:3.18 m · LENGTH:3.28 m
AREA:10.43 m² · PERIMETER:12.92 m

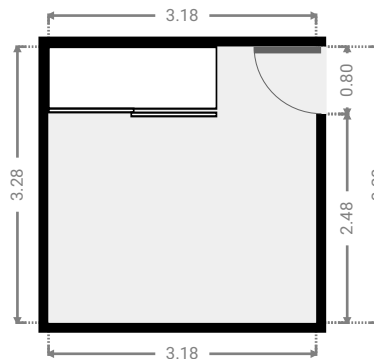
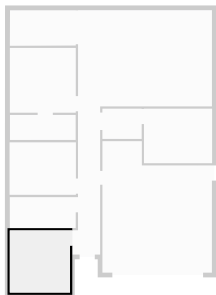

▼ **Bathroom**
Ground Floor

WIDTH:3.48 m · LENGTH:1.63 m
AREA:5.67 m² · PERIMETER:10.22 m

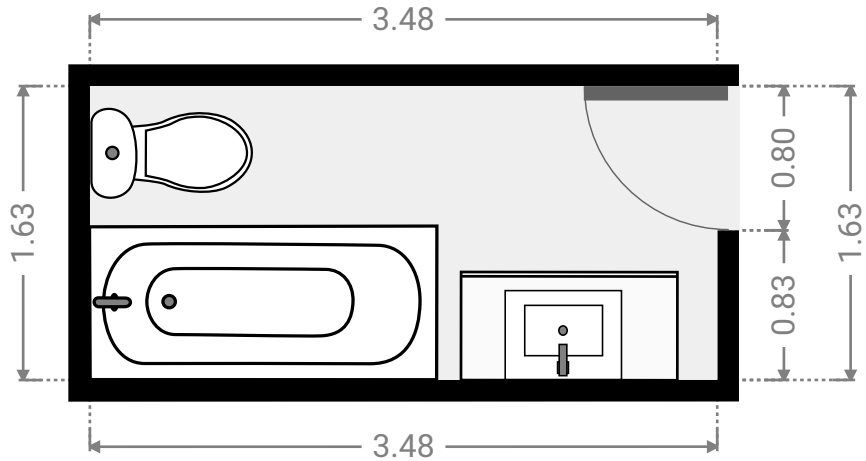
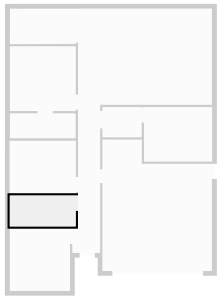

▼ **Bedroom**
Ground Floor

WIDTH:3.50 m · LENGTH:2.77 m
AREA:9.70 m² · PERIMETER:12.54 m

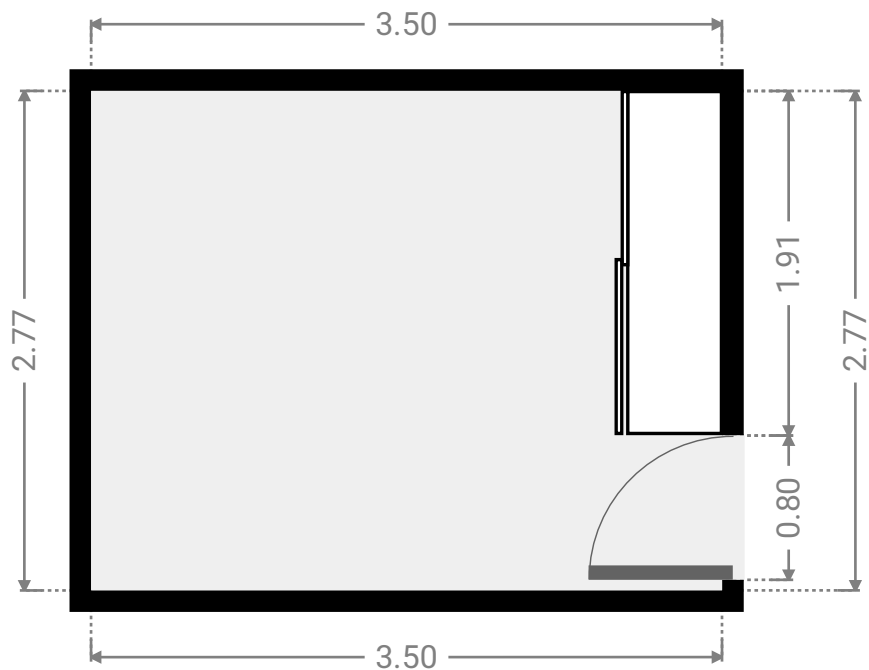
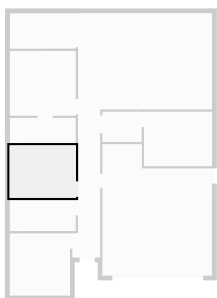

▼ **Garage**
Ground Floor

WIDTH:5.78 m · LENGTH:6.94 m
AREA:35.38 m² · PERIMETER:25.44 m

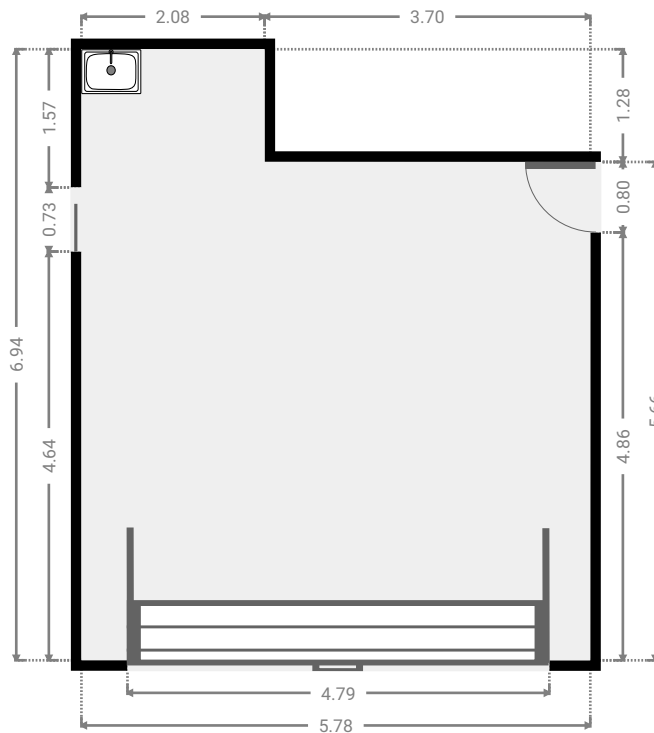
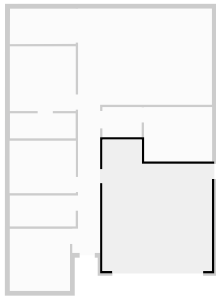

▼ **Hall**
Ground Floor

WIDTH:2.08 m · LENGTH:1.60 m
AREA:3.32 m² · PERIMETER:7.35 m

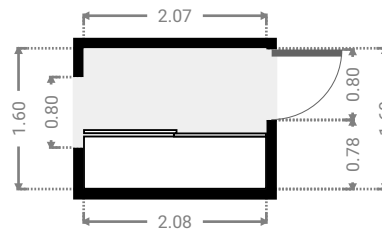
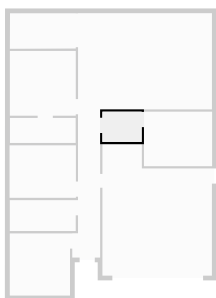

▼ Bedroom

Ground Floor

WIDTH:3.60 m · LENGTH:2.88 m
AREA:10.37 m² · PERIMETER:12.96 m

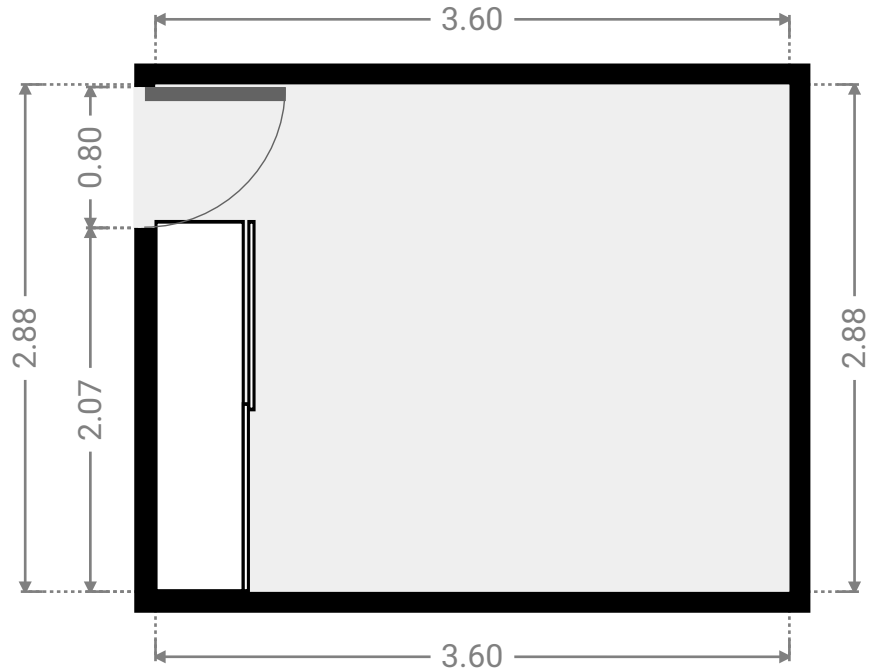
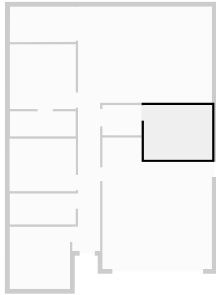

▼ Bathroom

Ground Floor

WIDTH:3.47 m · LENGTH:1.32 m
AREA:4.58 m² · PERIMETER:9.58 m

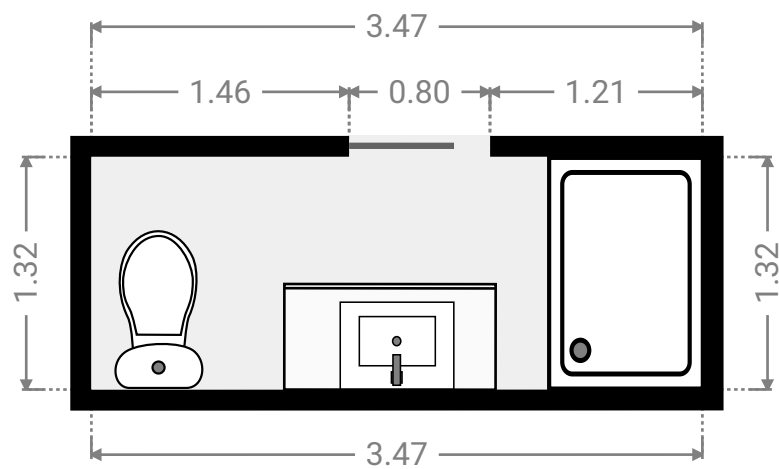
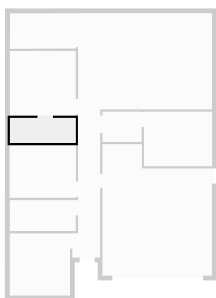

▼ Kitchen
Ground Floor

WIDTH:7.07 m · LENGTH:5.40 m
AREA:36.30 m² · PERIMETER:24.95 m

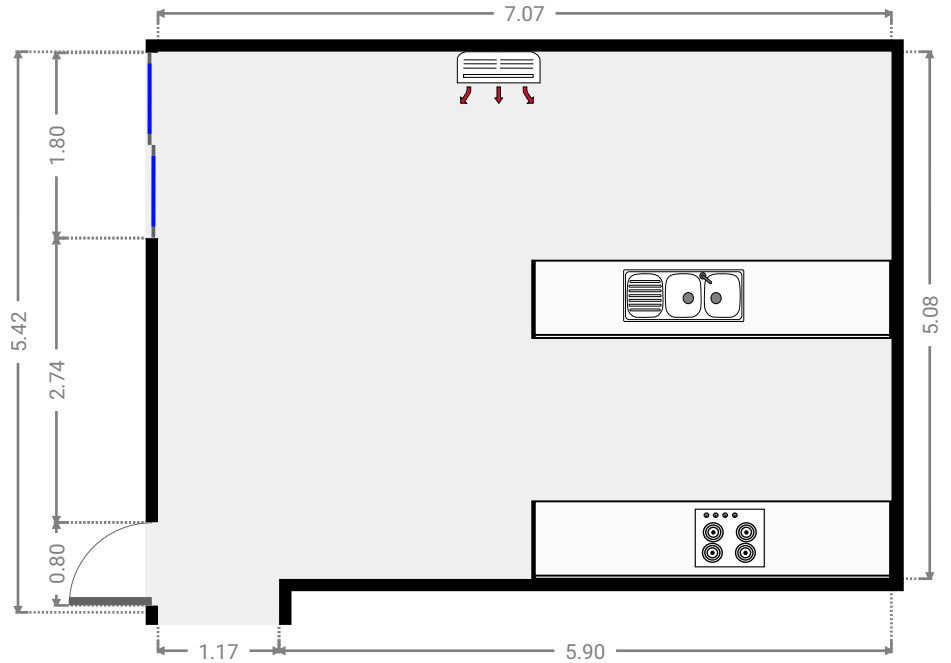
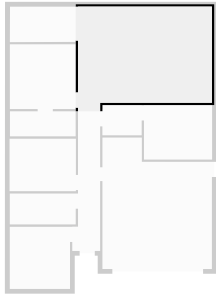

▼ Master Bedroom
Ground Floor

WIDTH:3.48 m · LENGTH:3.42 m
AREA:11.90 m² · PERIMETER:13.80 m

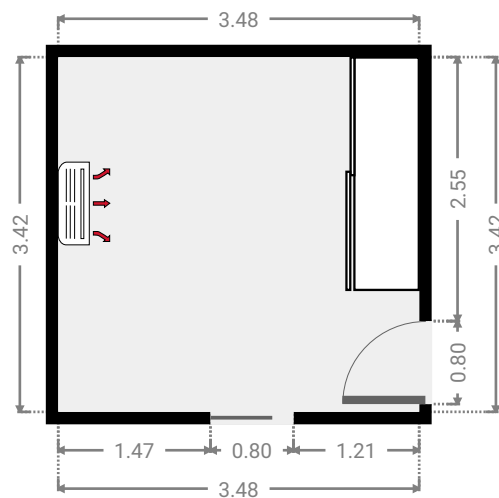
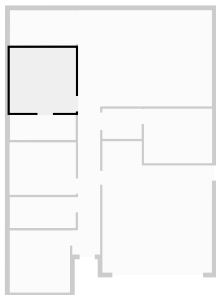

▼ Other
Ground Floor

WIDTH:3.49 m · LENGTH:1.87 m
AREA:6.49 m² · PERIMETER:10.69 m

