

49 Davis Street

Ground Floor

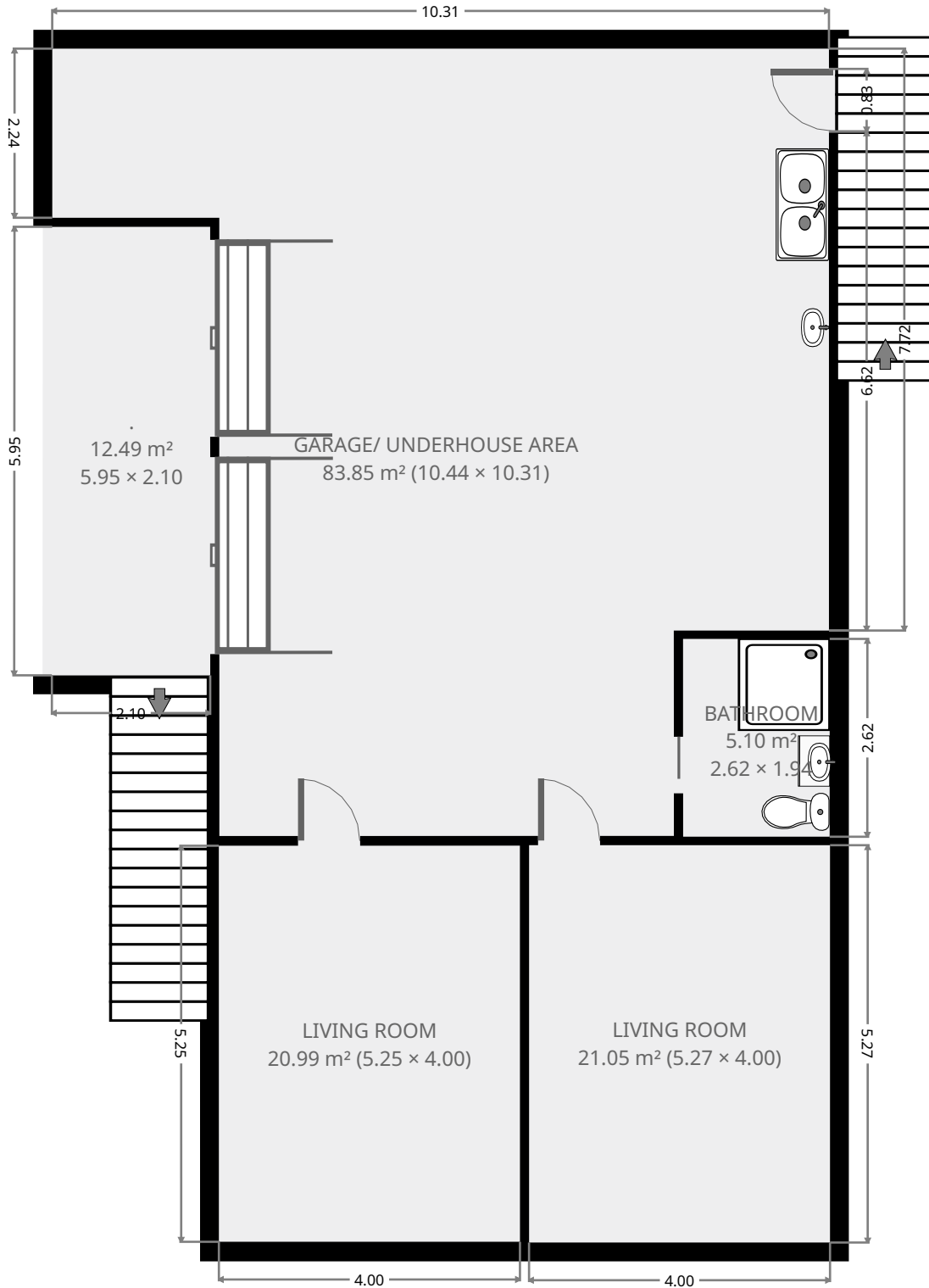

THIS FLOORPLAN IS PROVIDED WITHOUT WARRANTY OF ANY KIND. SENSOPIA DISCLAIMS ANY WARRANTY INCLUDING, WITHOUT LIMITATION, SATISFACTORY QUALITY OR ACCURACY OF DIMENSIONS.

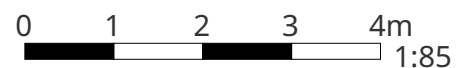

49 Davis Street

Garage/ Underhouse Area

Width:	10.31 m
Length:	10.44 m
Area	83.85 m ²
Perimeter	41.50 m

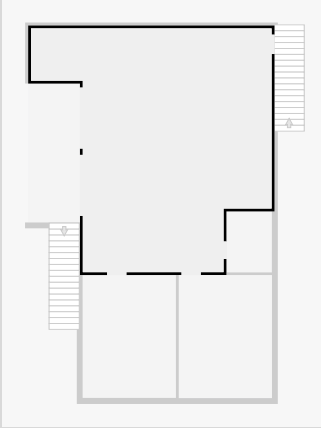

THIS FLOORPLAN IS PROVIDED WITHOUT WARRANTY OF ANY KIND. SENSOPIA DISCLAIMS ANY WARRANTY INCLUDING, WITHOUT LIMITATION, SATISFACTORY QUALITY OR ACCURACY OF DIMENSIONS.

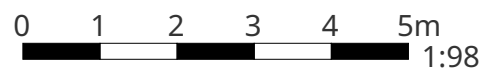

49 Davis Street

Bathroom

Width: 1.94 m
Length: 2.62 m
Area: 5.10 m²
Perimeter: 9.14 m

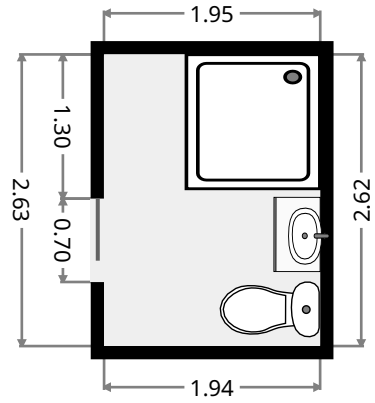
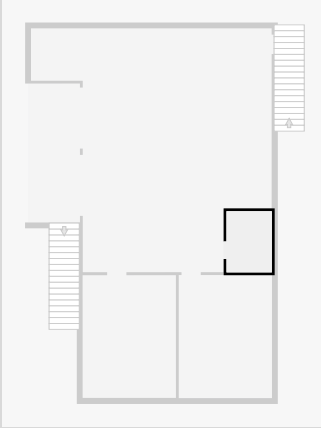

Living Room

Width: 4.00 m
Length: 5.27 m
Area: 21.05 m²
Perimeter: 18.53 m

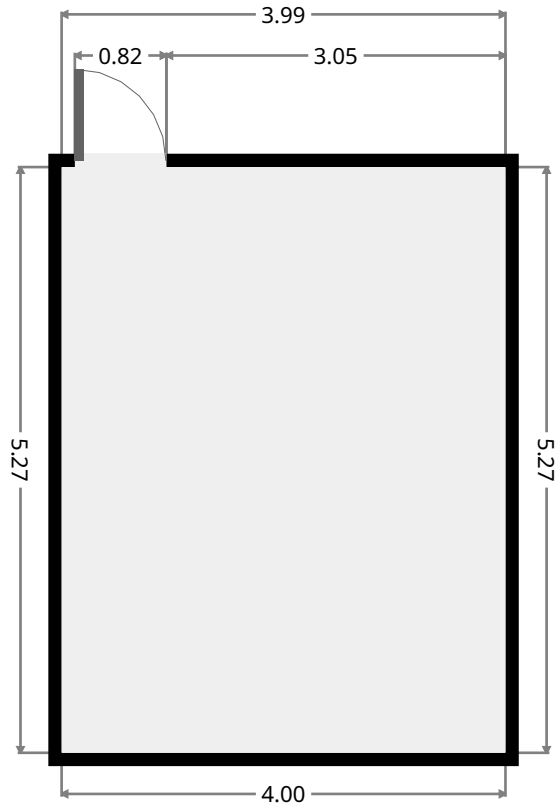
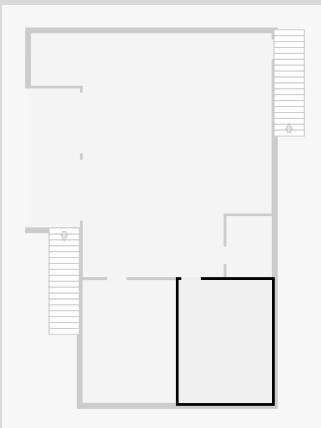

THIS FLOORPLAN IS PROVIDED WITHOUT WARRANTY OF ANY KIND. SENSOPIA DISCLAIMS ANY WARRANTY INCLUDING, WITHOUT LIMITATION, SATISFACTORY QUALITY OR ACCURACY OF DIMENSIONS.

49 Davis Street

Living Room

Width: 4.00 m
 Length: 5.25 m
 Area: 20.99 m²
 Perimeter: 18.50 m

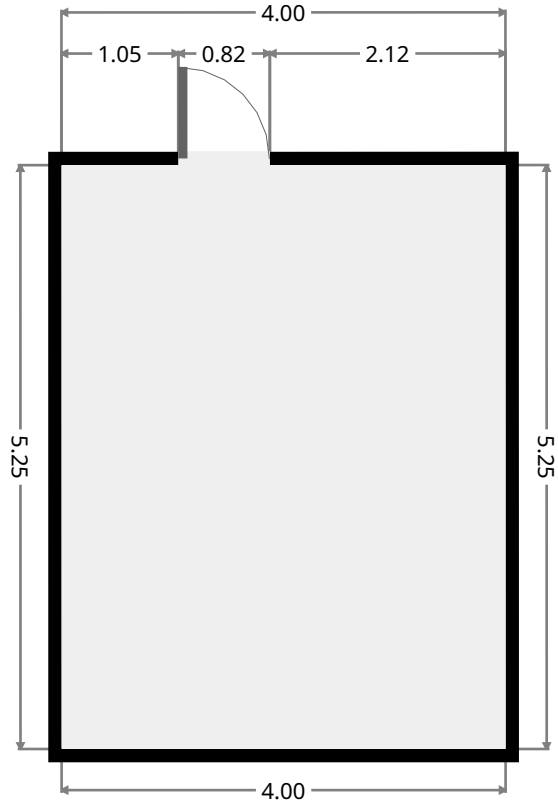
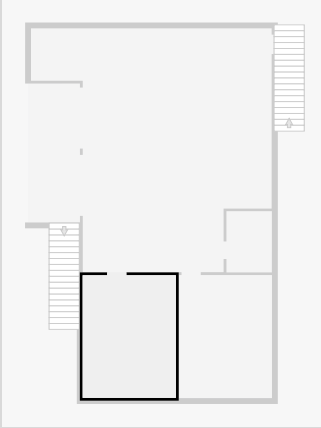

•
 Width: 2.10 m
 Length: 5.95 m
 Area: 12.49 m²
 Perimeter: 16.10 m

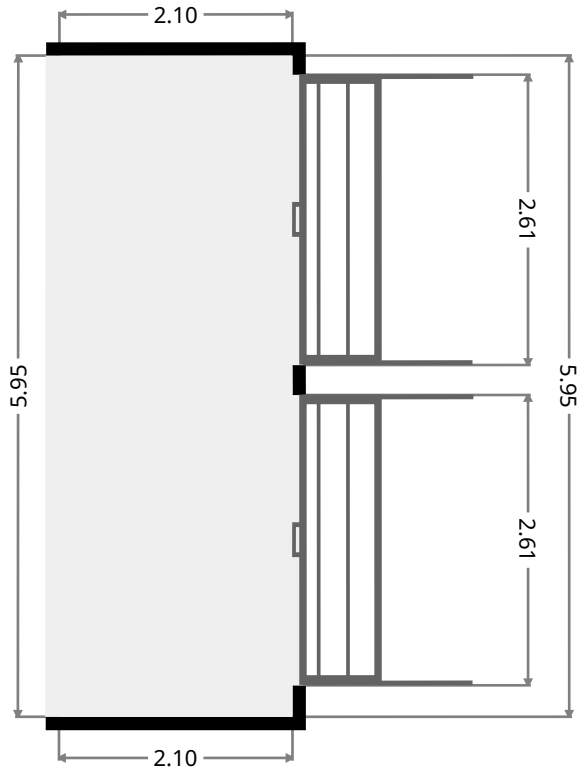
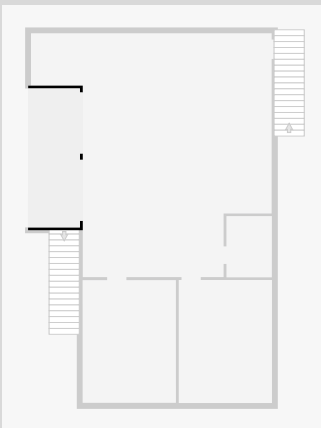

THIS FLOORPLAN IS PROVIDED WITHOUT WARRANTY OF ANY KIND. SENSOPIA DISCLAIMS ANY WARRANTY INCLUDING, WITHOUT LIMITATION, SATISFACTORY QUALITY OR ACCURACY OF DIMENSIONS.



49 Davis Street

1st Floor



THIS FLOORPLAN IS PROVIDED WITHOUT WARRANTY OF ANY KIND. SENSOPIA DISCLAIMS ANY WARRANTY INCLUDING, WITHOUT LIMITATION, SATISFACTORY QUALITY OR ACCURACY OF DIMENSIONS.

49 Davis Street

Kitchen

Width: 3.72 m
Length: 3.91 m
Area: 14.38 m²
Perimeter: 14.95 m

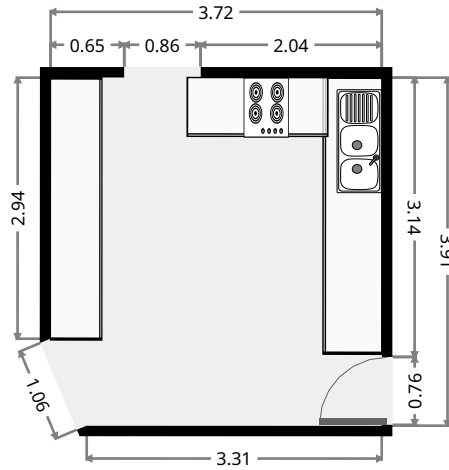
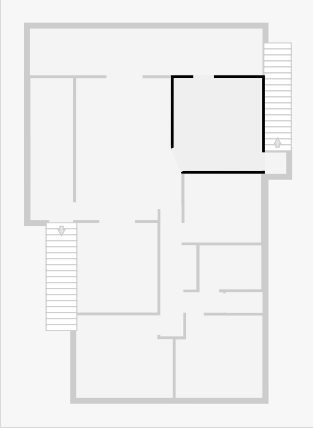

Sleepout

Width: 1.97 m
Length: 9.82 m
Area: 19.34 m²
Perimeter: 23.58 m

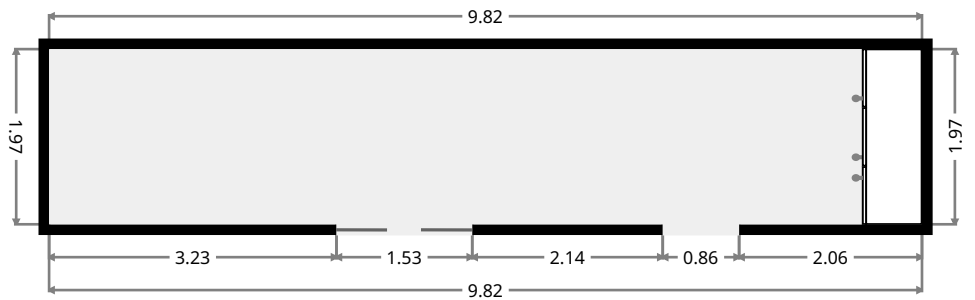
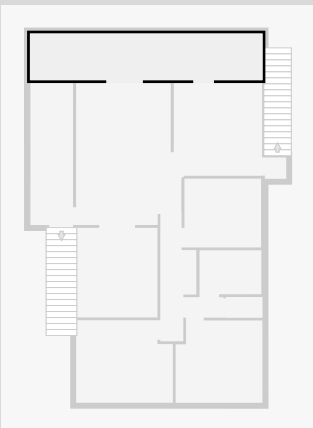

THIS FLOORPLAN IS PROVIDED WITHOUT WARRANTY OF ANY KIND. SENSOPIA DISCLAIMS ANY WARRANTY INCLUDING, WITHOUT LIMITATION, SATISFACTORY QUALITY OR ACCURACY OF DIMENSIONS.



49 Davis Street

Living Room

Width: 4.44 m
Length: 5.99 m
Area: 24.46 m²
Perimeter: 20.50 m

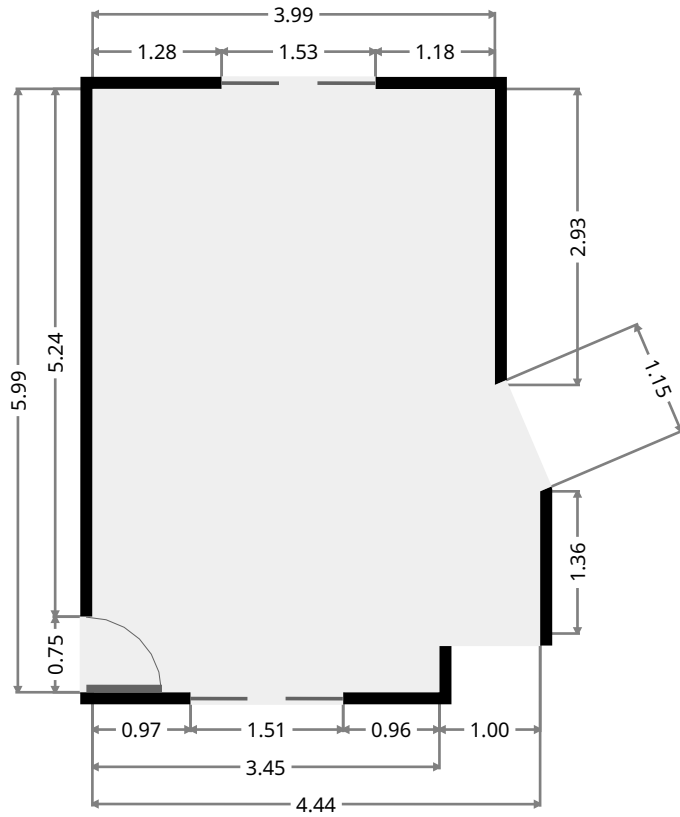
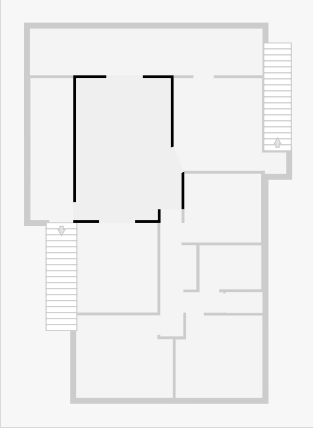

Dining Room

Width: 3.43 m
Length: 3.78 m
Area: 12.97 m²
Perimeter: 14.42 m

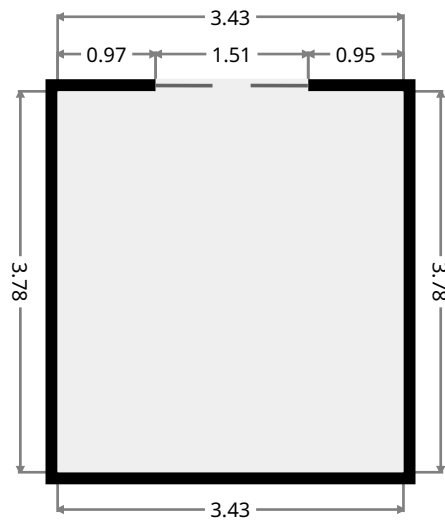
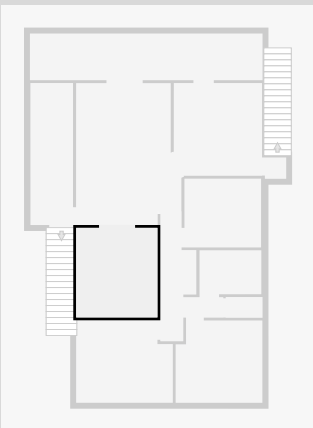

49 Davis Street

Hall

Width: 1.52 m
 Length: 5.37 m
 Area: 6.12 m²
 Perimeter: 13.77 m

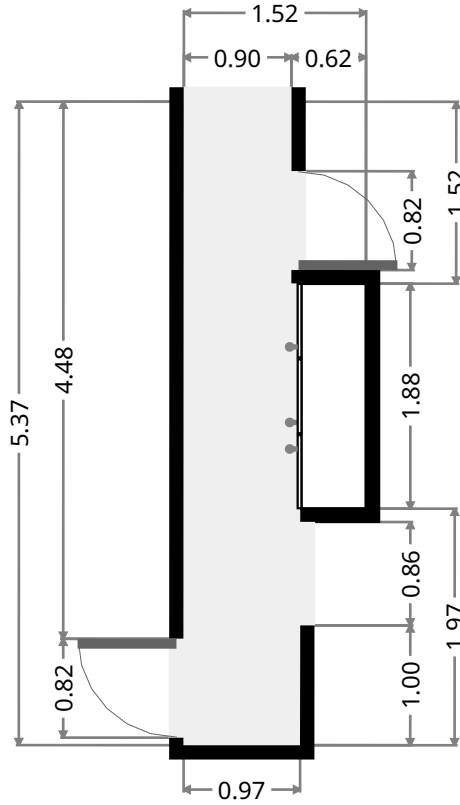
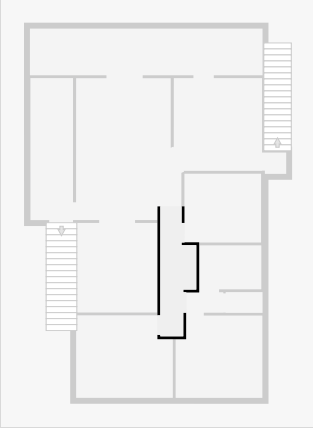

Bedroom

Width: 2.90 m
 Length: 3.23 m
 Area: 9.39 m²
 Perimeter: 12.27 m

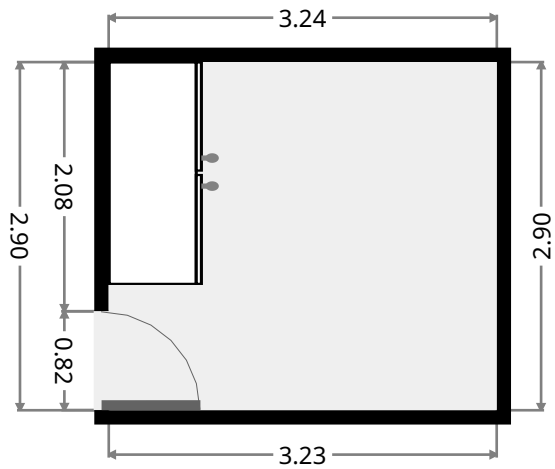
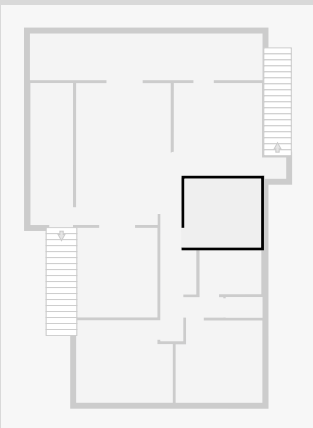

49 Davis Street

Hall

Width: 0.86 m
 Length: 1.60 m
 Area: 1.37 m²
 Perimeter: 4.90 m

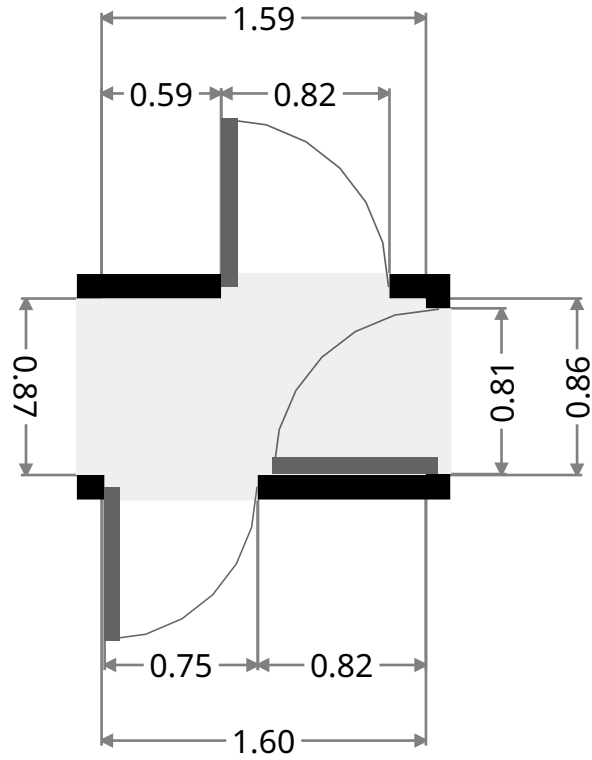
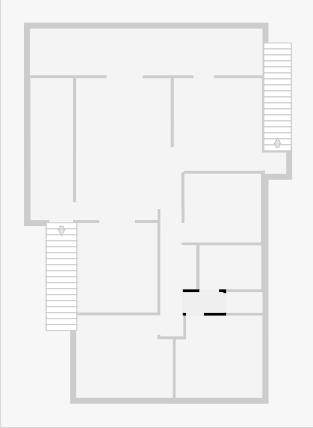

Bathroom

Width: 1.85 m
 Length: 2.60 m
 Area: 4.84 m²
 Perimeter: 8.93 m

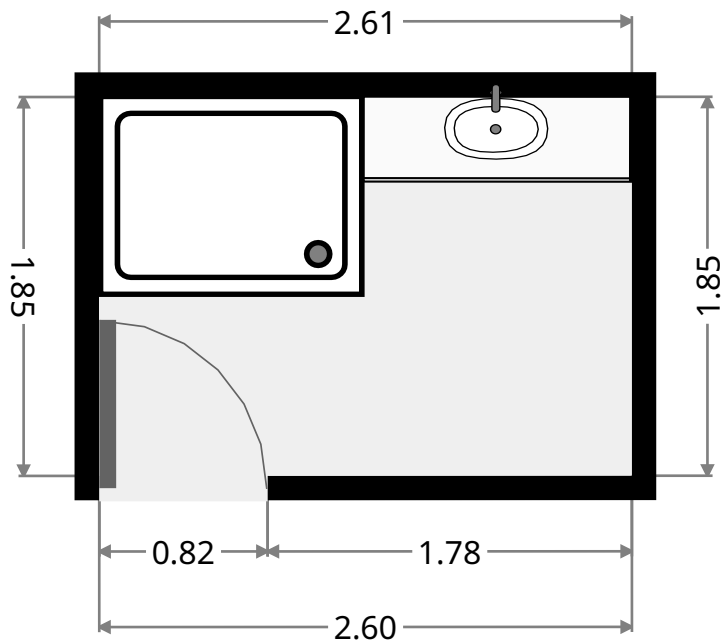
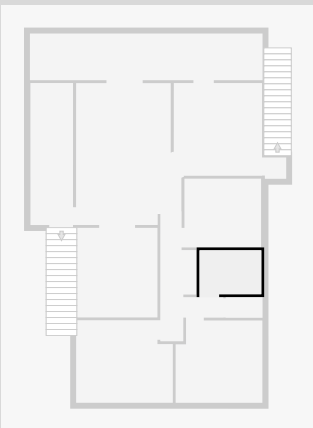

49 Davis Street

Toilet

Width: 0.88 m
Length: 1.56 m
Area: 1.36 m²
Perimeter: 4.86 m

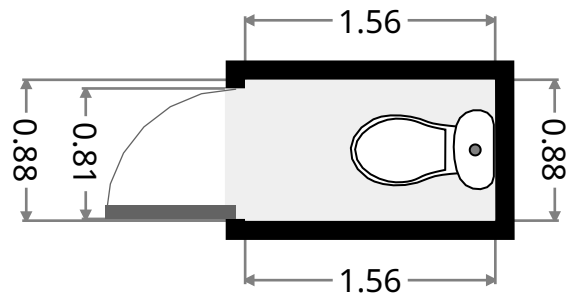
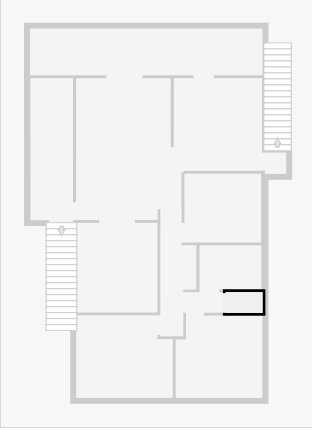

Bedroom

Width: 3.48 m
Length: 3.66 m
Area: 12.27 m²
Perimeter: 14.27 m

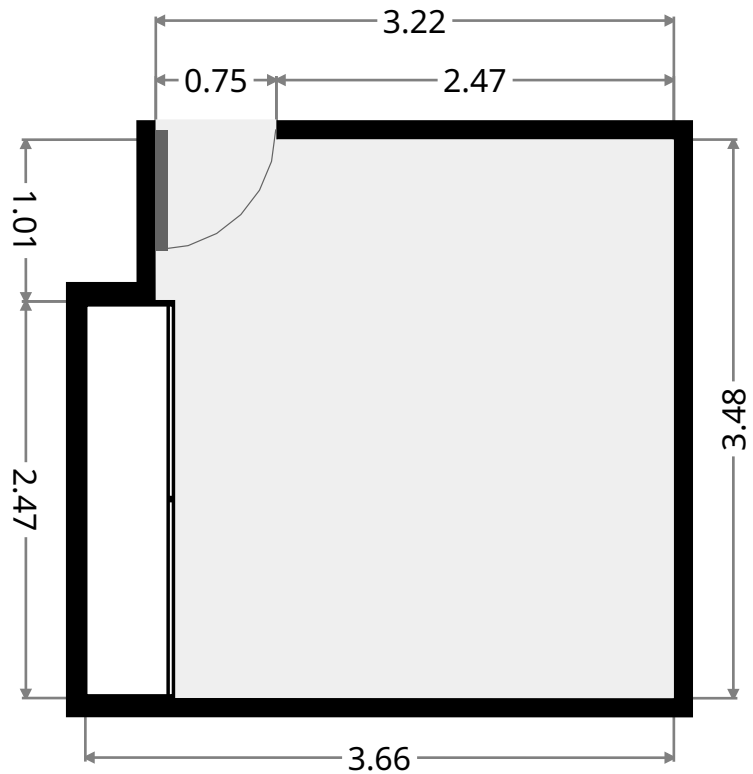
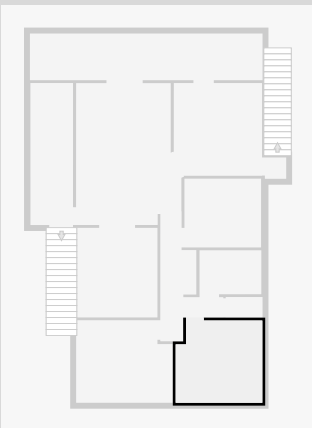

49 Davis Street

Bedroom

Width: 3.48 m
Length: 4.08 m
Area: 13.55 m²
Perimeter: 15.13 m

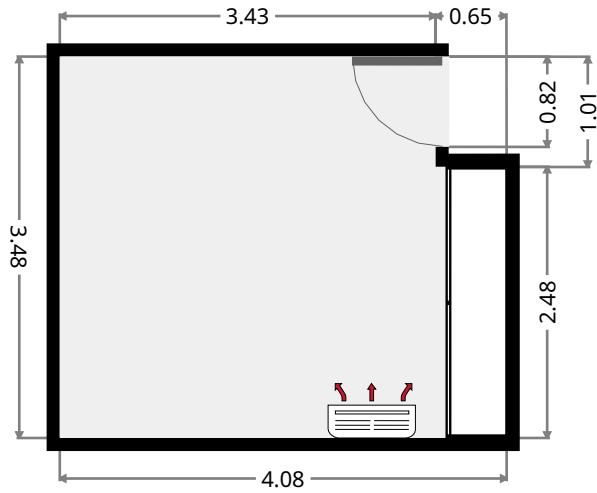
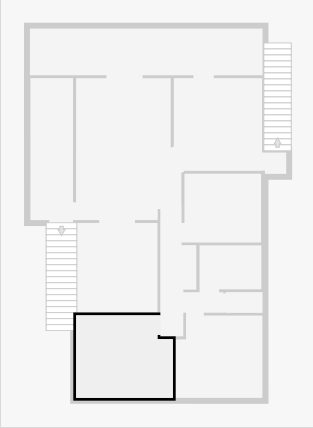

Verandah

Width: 1.79 m
Length: 5.99 m
Area: 10.78 m²
Perimeter: 15.59 m

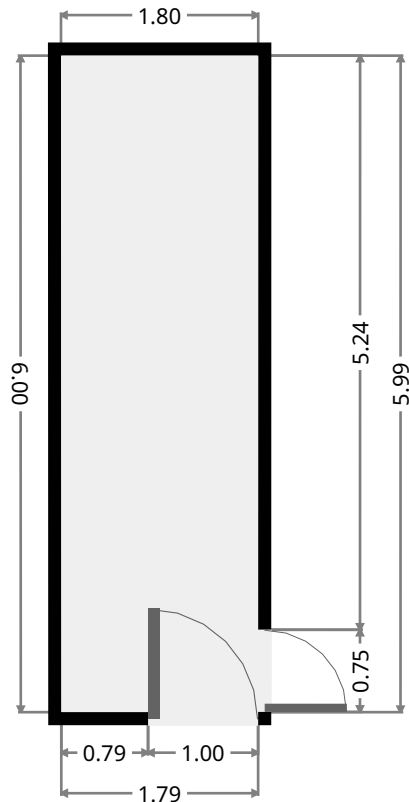
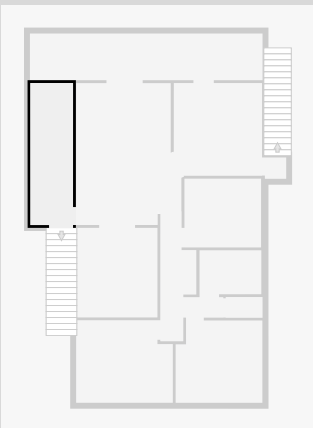

49 Davis Street

•
Width: 0.90 m
Length: 0.90 m
Area 0.81 m²
Perimeter 3.60 m

