

# Ground Floor

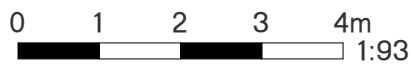
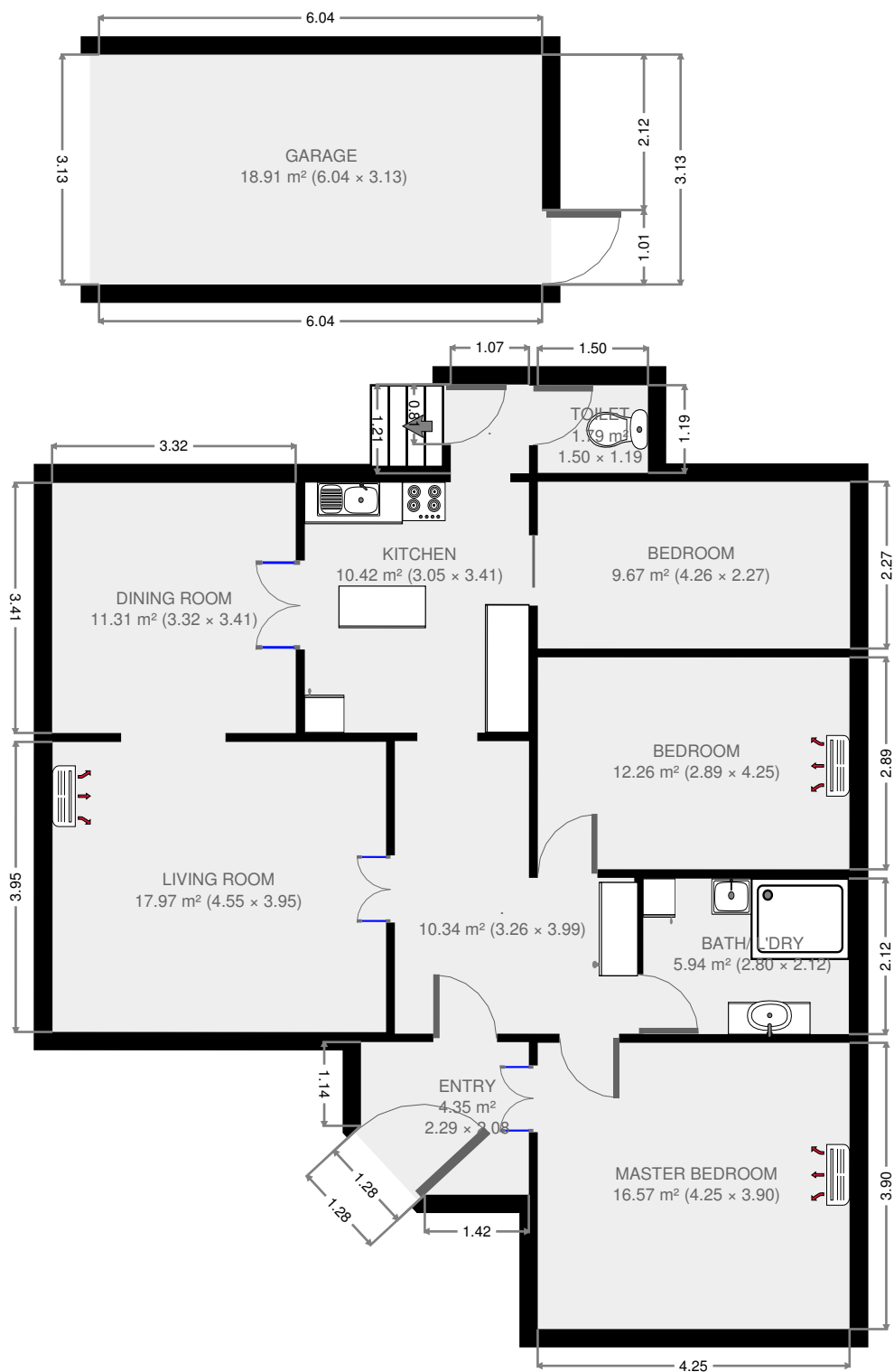

48 Brae Street

THIS FLOORPLAN IS PROVIDED WITHOUT WARRANTY OF ANY KIND. SENSOPIA DISCLAIMS ANY WARRANTY INCLUDING, WITHOUT LIMITATION, SATISFACTORY QUALITY OR ACCURACY OF DIMENSIONS.

Width: 3.26 m  
 Length: 3.99 m  
 Area: 10.34 m<sup>2</sup>  
 Perimeter: 14.50 m

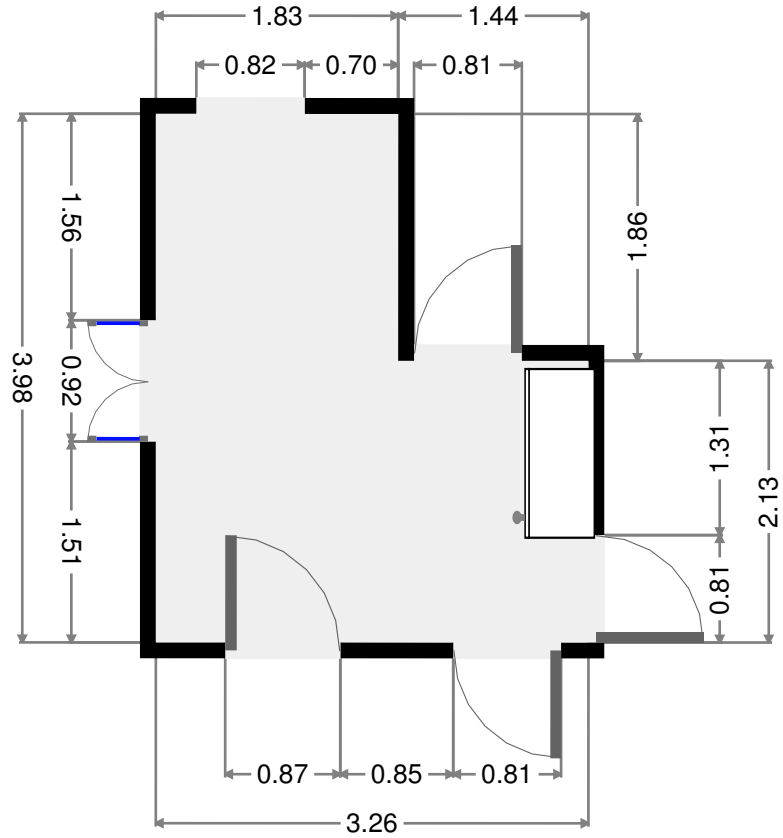
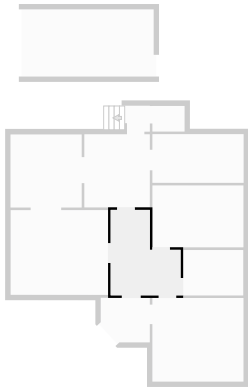

## Master Bedroom

Width: 3.90 m  
 Length: 4.25 m  
 Area: 16.57 m<sup>2</sup>  
 Perimeter: 16.30 m

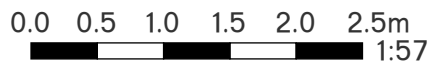
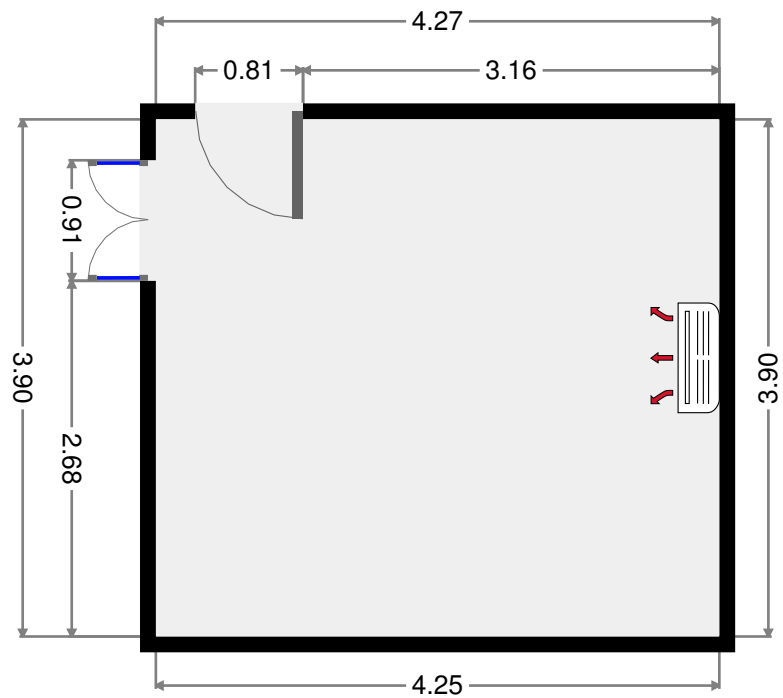
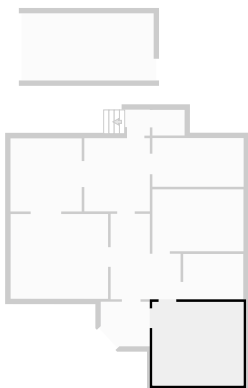

THIS FLOORPLAN IS PROVIDED WITHOUT WARRANTY OF ANY KIND. SENSOPIA DISCLAIMS ANY WARRANTY INCLUDING, WITHOUT LIMITATION, SATISFACTORY QUALITY OR ACCURACY OF DIMENSIONS.

# Bath/ L'dry

Width: 2.12 m  
 Length: 2.80 m  
 Area: 5.94 m<sup>2</sup>  
 Perimeter: 9.84 m

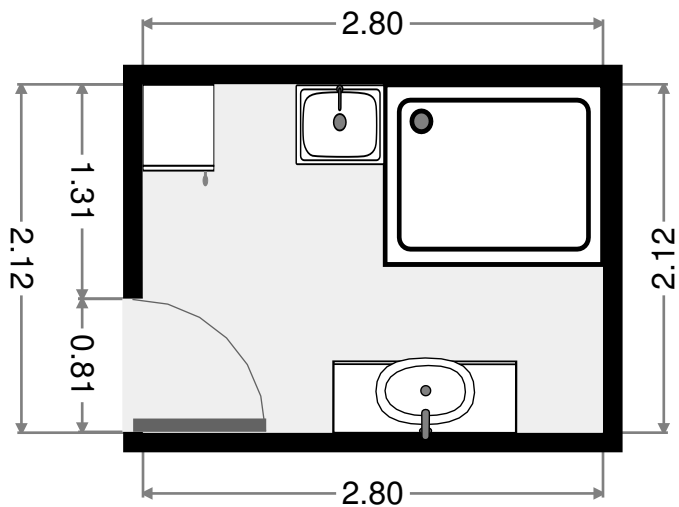
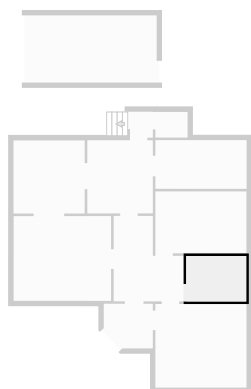

# Bedroom

Width: 2.89 m  
 Length: 4.25 m  
 Area: 12.26 m<sup>2</sup>  
 Perimeter: 14.27 m

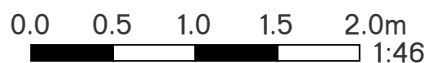
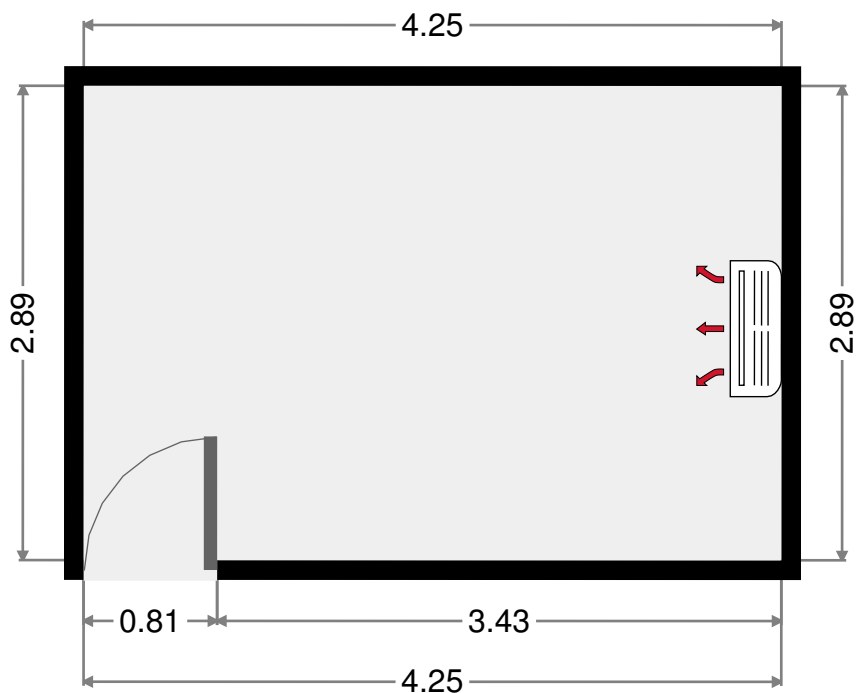
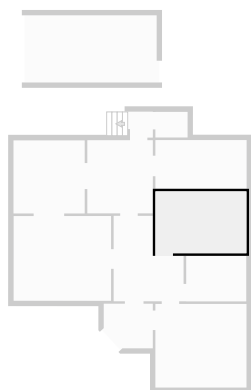

THIS FLOORPLAN IS PROVIDED WITHOUT WARRANTY OF ANY KIND. SENSOPIA DISCLAIMS ANY WARRANTY INCLUDING, WITHOUT LIMITATION, SATISFACTORY QUALITY OR ACCURACY OF DIMENSIONS.

# Living Room

Width: 3.95 m  
 Length: 4.55 m  
 Area: 17.97 m<sup>2</sup>  
 Perimeter: 17.00 m

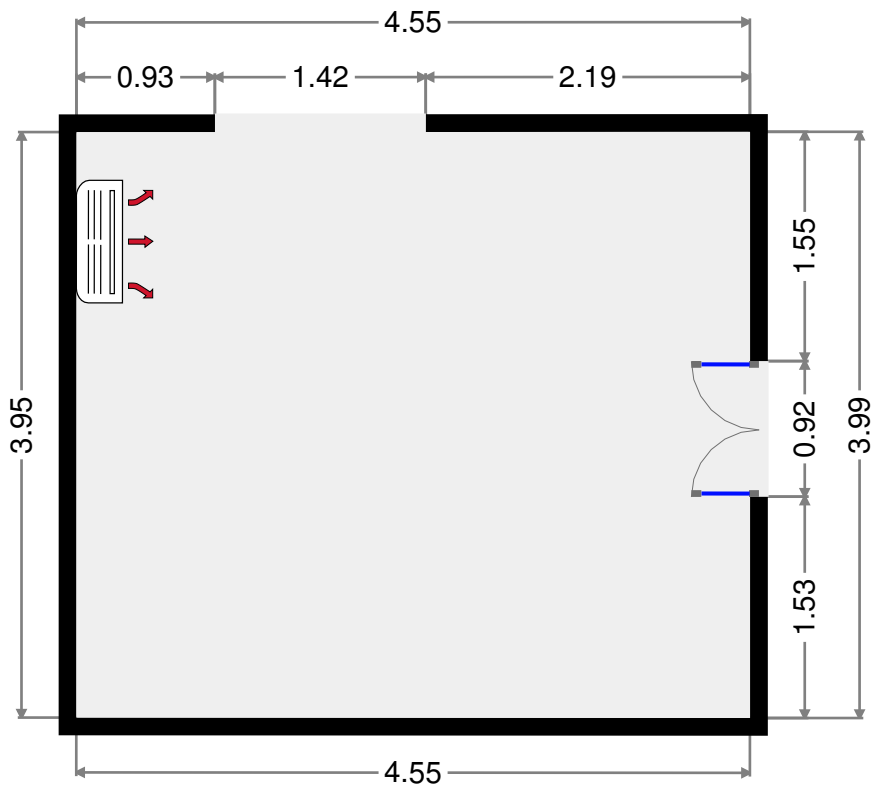
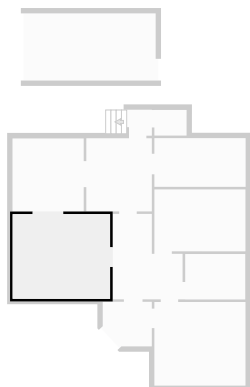

# Dining Room

Width: 3.32 m  
 Length: 3.41 m  
 Area: 11.31 m<sup>2</sup>  
 Perimeter: 13.46 m

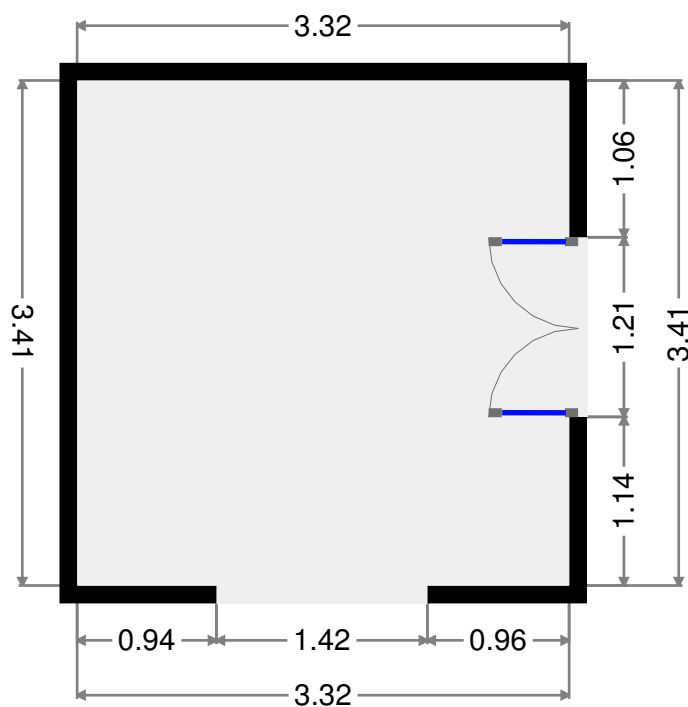
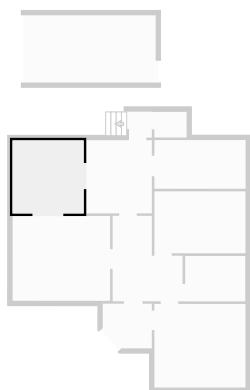

THIS FLOORPLAN IS PROVIDED WITHOUT WARRANTY OF ANY KIND. SENSOPIA DISCLAIMS ANY WARRANTY INCLUDING, WITHOUT LIMITATION, SATISFACTORY QUALITY OR ACCURACY OF DIMENSIONS.

# Kitchen

Width: 3.05 m  
 Length: 3.41 m  
 Area: 10.42 m<sup>2</sup>  
 Perimeter: 12.93 m

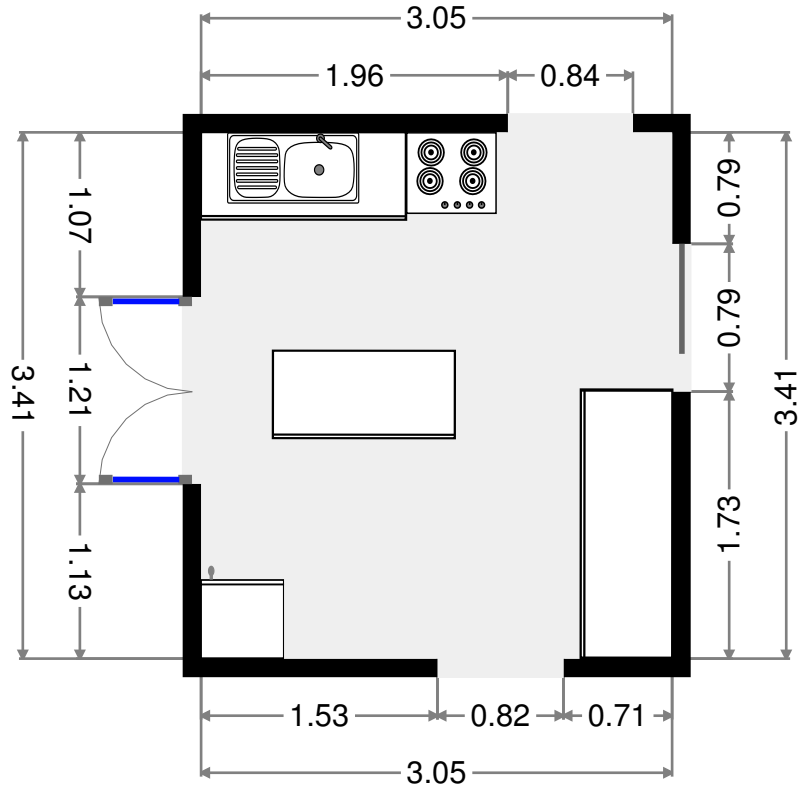
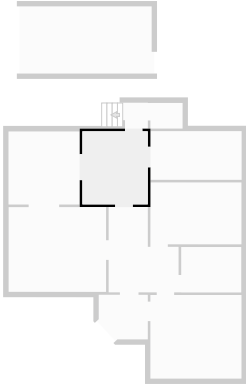

# Bedroom

Width: 2.27 m  
 Length: 4.26 m  
 Area: 9.67 m<sup>2</sup>  
 Perimeter: 13.06 m

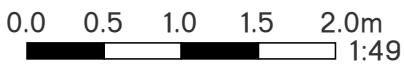
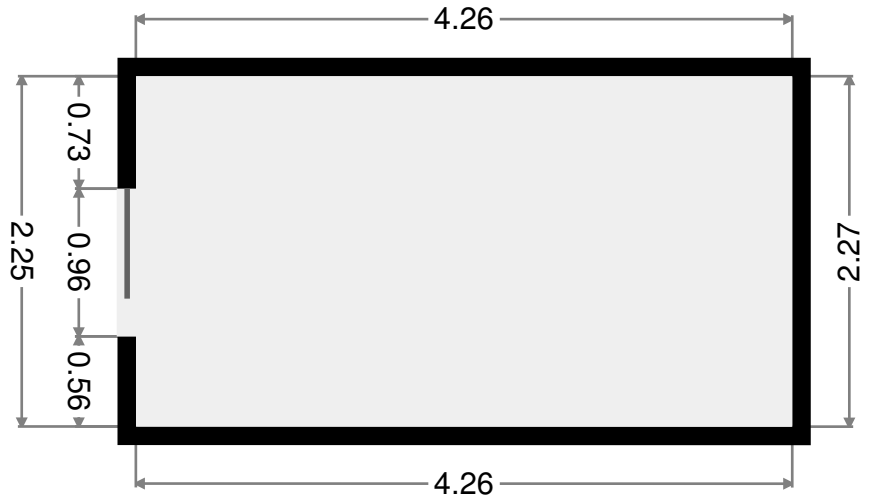
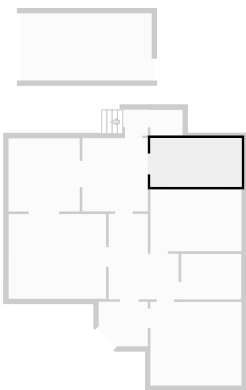

THIS FLOORPLAN IS PROVIDED WITHOUT WARRANTY OF ANY KIND. SENSOPIA DISCLAIMS ANY WARRANTY INCLUDING, WITHOUT LIMITATION, SATISFACTORY QUALITY OR ACCURACY OF DIMENSIONS.

- Width: 1.07 m  
 Length: 1.21 m  
 Area: 1.29 m<sup>2</sup>  
 Perimeter: 4.55 m

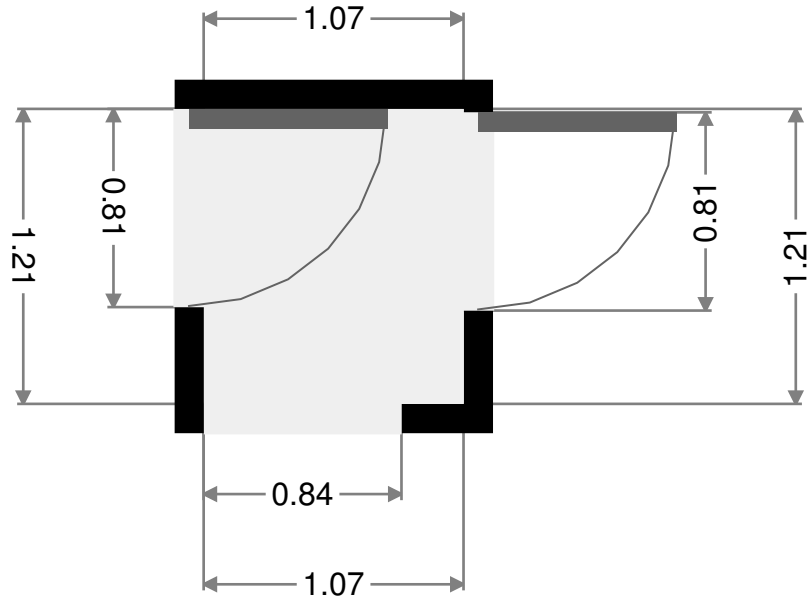
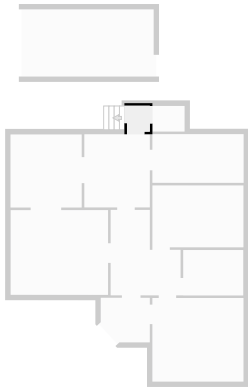

## Toilet

- Width: 1.19 m  
 Length: 1.50 m  
 Area: 1.79 m<sup>2</sup>  
 Perimeter: 5.39 m

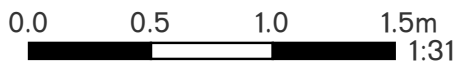
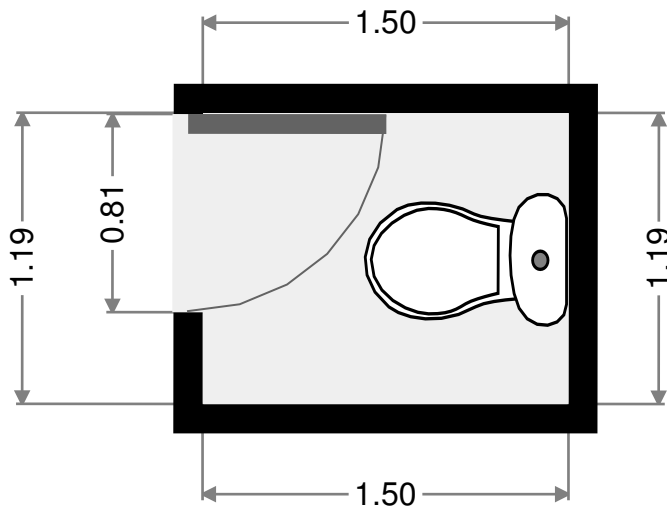
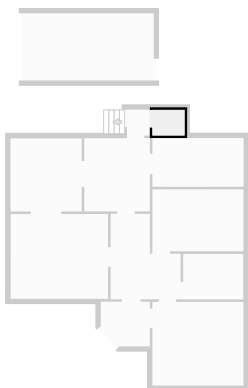

THIS FLOORPLAN IS PROVIDED WITHOUT WARRANTY OF ANY KIND. SENSOPIA DISCLAIMS ANY WARRANTY INCLUDING, WITHOUT LIMITATION, SATISFACTORY QUALITY OR ACCURACY OF DIMENSIONS.

# Entry

Width: 2.08 m  
 Length: 2.29 m  
 Area: 4.35 m<sup>2</sup>  
 Perimeter: 8.21 m

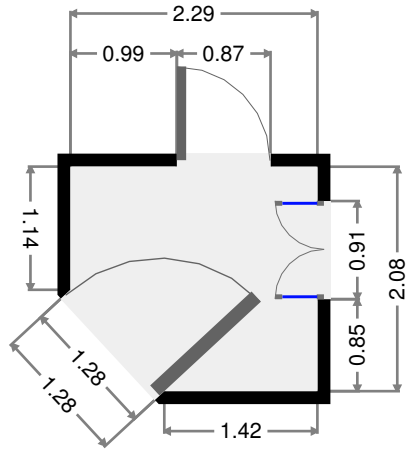
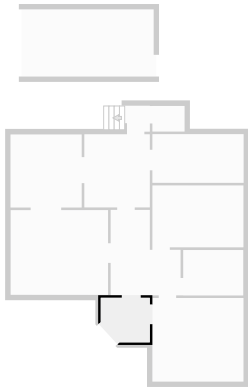

# Garage

Width: 3.13 m  
 Length: 6.04 m  
 Area: 18.91 m<sup>2</sup>  
 Perimeter: 18.34 m

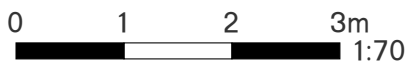
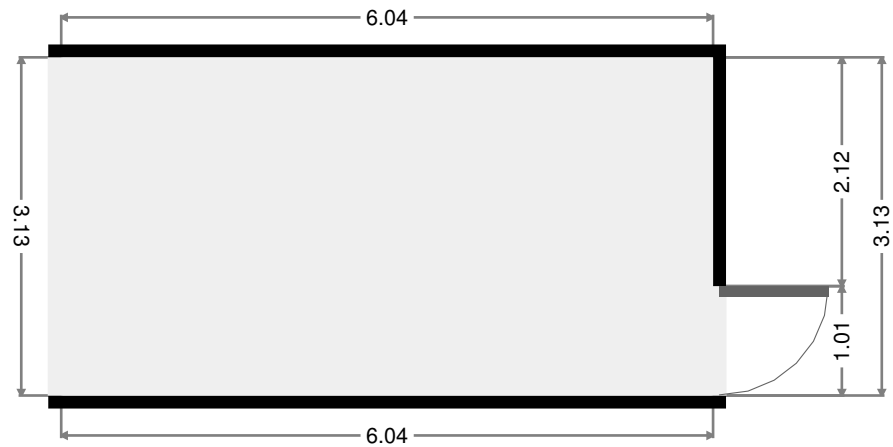
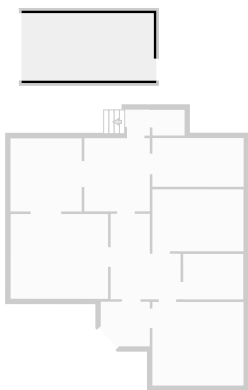

THIS FLOORPLAN IS PROVIDED WITHOUT WARRANTY OF ANY KIND. SENSOPIA DISCLAIMS ANY WARRANTY INCLUDING, WITHOUT LIMITATION, SATISFACTORY QUALITY OR ACCURACY OF DIMENSIONS.