

48 Bean Avenue

Created on
2021-01-21

Floors
1

▼ Ground Floor

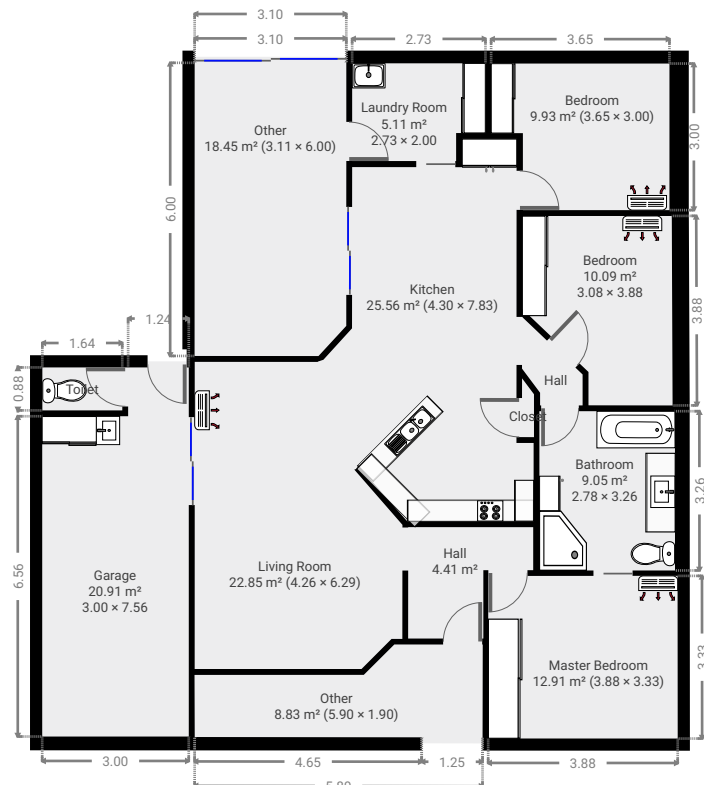
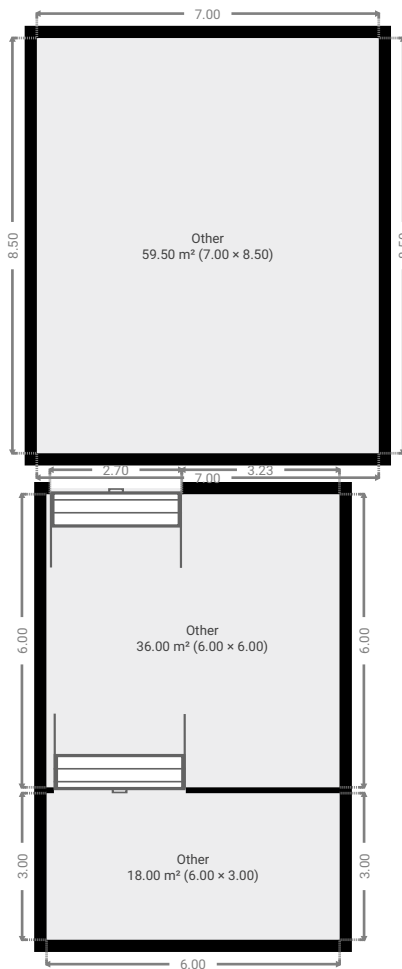

▼ Bedroom Ground Floor

WIDTH: 3.65 m • LENGTH: 3.00 m
AREA: 9.93 m² • PERIMETER: 13.30 m

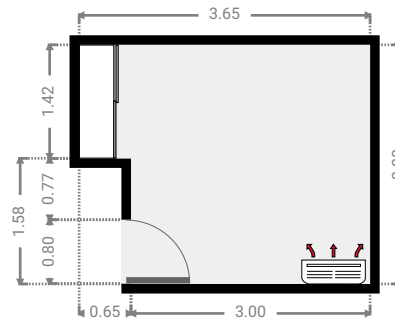
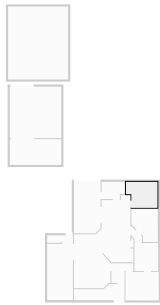

▼ Other Ground Floor

WIDTH: 7.00 m • LENGTH: 8.50 m
AREA: 59.50 m² • PERIMETER: 31.00 m

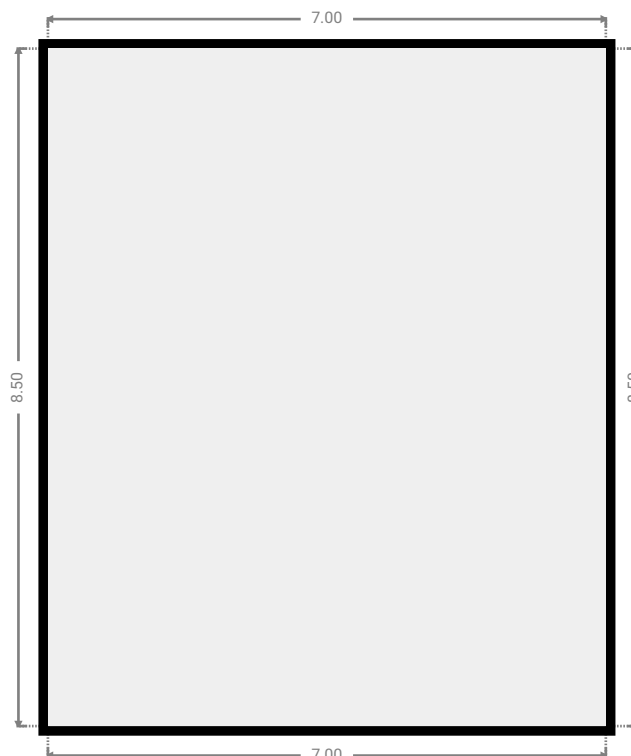
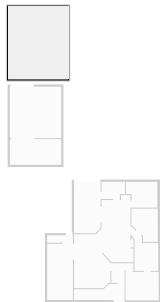

▼ Other
Ground Floor

WIDTH: 6.00 m • LENGTH: 6.00 m
AREA: 36.00 m² • PERIMETER: 24.00 m

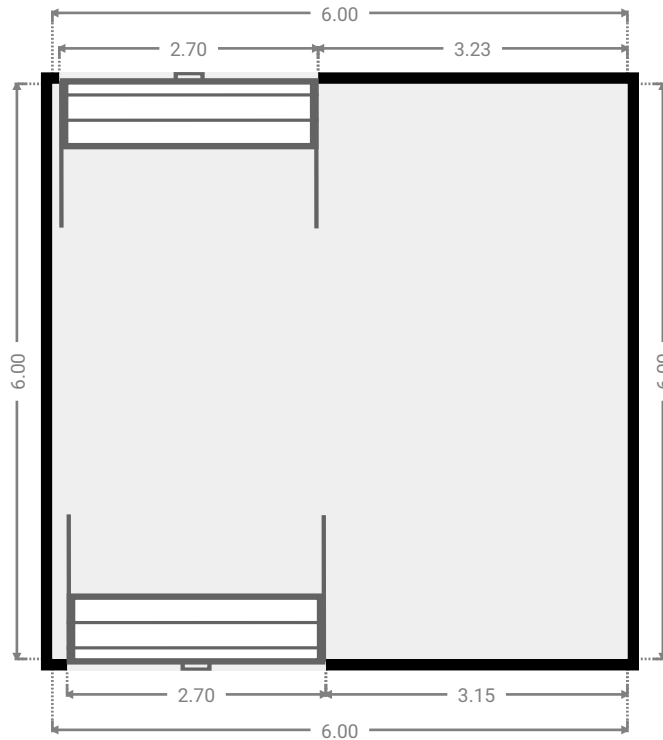
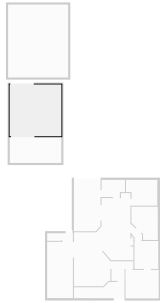

▼ Other
Ground Floor

WIDTH: 6.00 m • LENGTH: 3.00 m
AREA: 18.00 m² • PERIMETER: 18.00 m

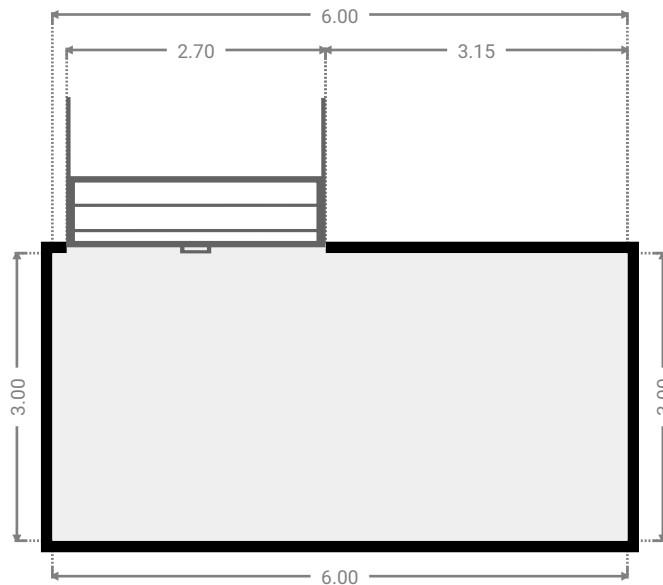
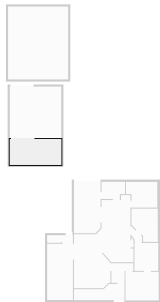

▼ Other
Ground Floor

WIDTH: 5.90 m • LENGTH: 1.90 m
AREA: 8.83 m² • PERIMETER: 15.22 m

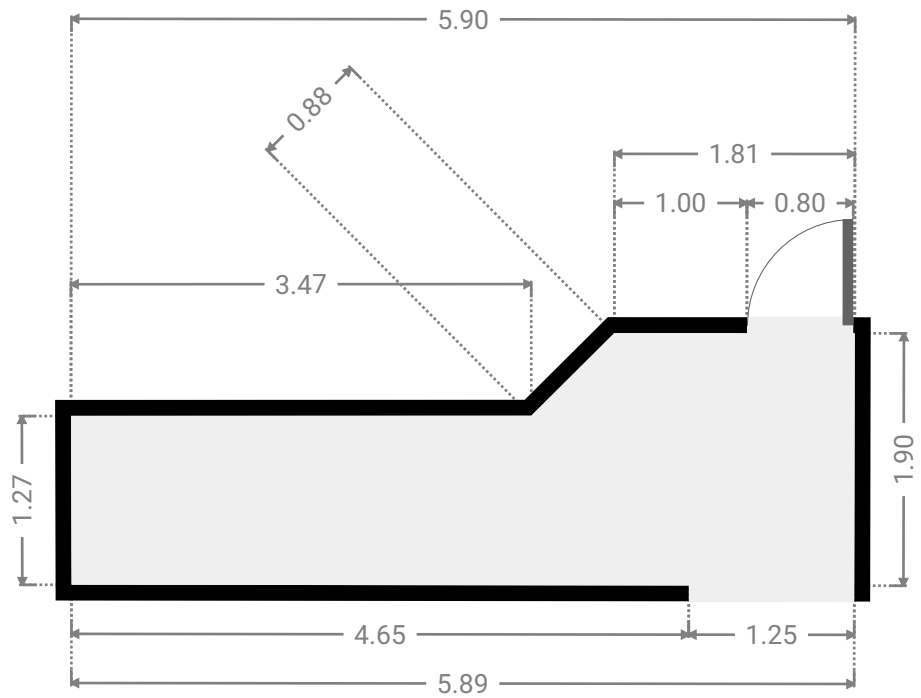
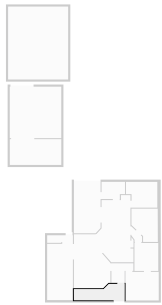

▼ Toilet
Ground Floor

WIDTH: 1.64 m • LENGTH: 0.88 m
AREA: 1.44 m² • PERIMETER: 5.03 m

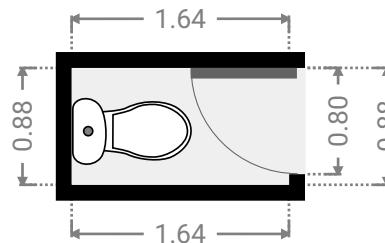
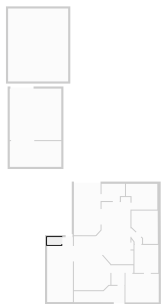

▼ **Garage**
Ground Floor

WIDTH: 3.00 m • LENGTH: 7.56 m
AREA: 20.91 m² • PERIMETER: 21.11 m

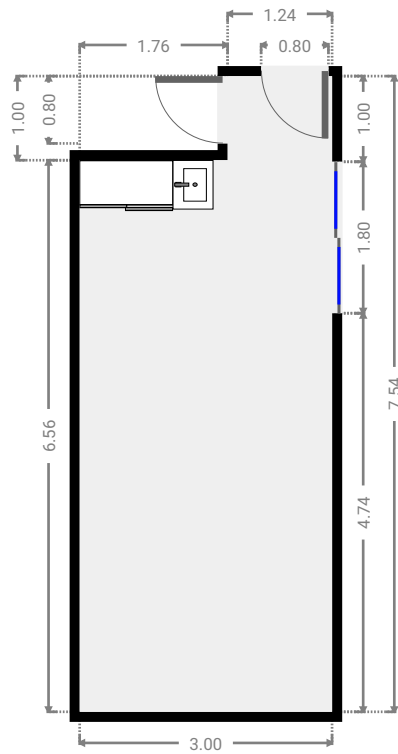
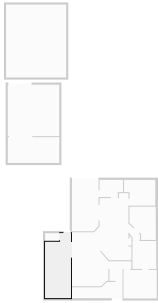

▼ **Other**
Ground Floor

WIDTH: 3.11 m • LENGTH: 6.00 m
AREA: 18.45 m² • PERIMETER: 17.86 m

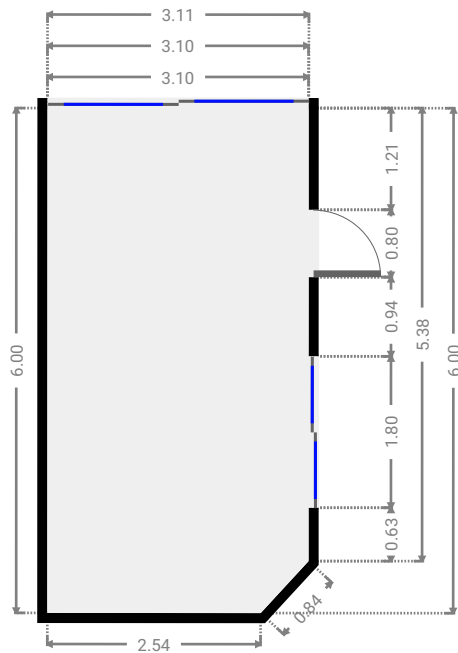

▼ **Bedroom**
Ground Floor

WIDTH: 3.08 m • LENGTH: 3.88 m
AREA: 10.09 m² • PERIMETER: 13.11 m

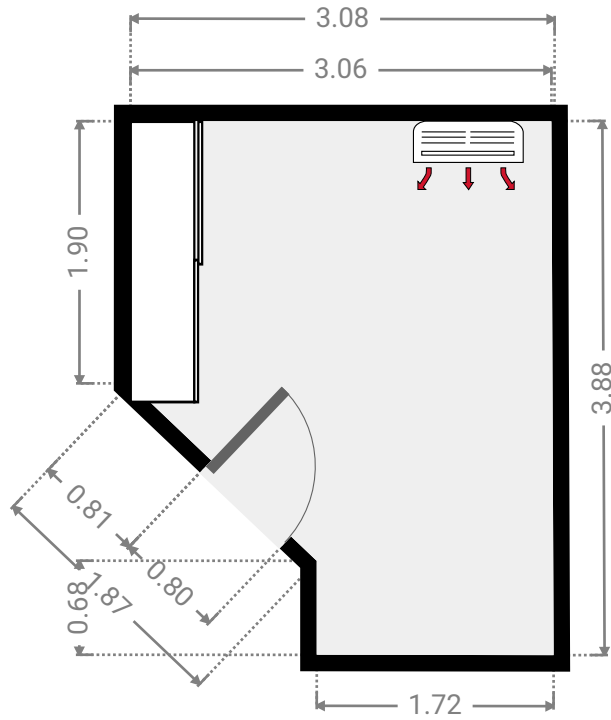
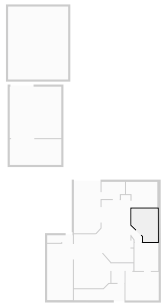

▼ **Hall**
Ground Floor

WIDTH: 2.56 m • LENGTH: 2.28 m
AREA: 4.41 m² • PERIMETER: 9.68 m

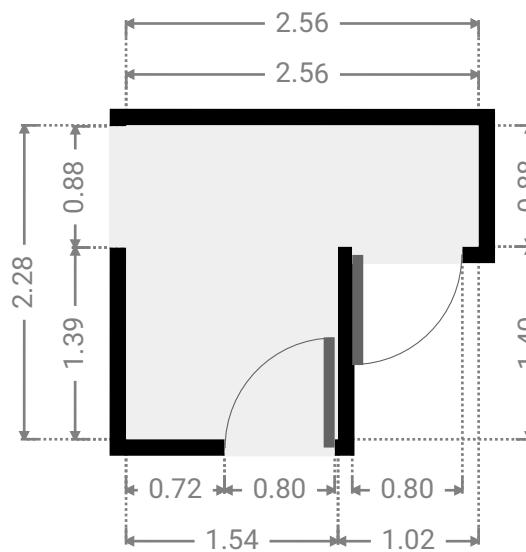
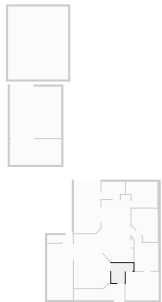

▼ Laundry Room
Ground Floor

WIDTH: 2.73 m • LENGTH: 2.00 m
AREA: 5.11 m² • PERIMETER: 9.46 m

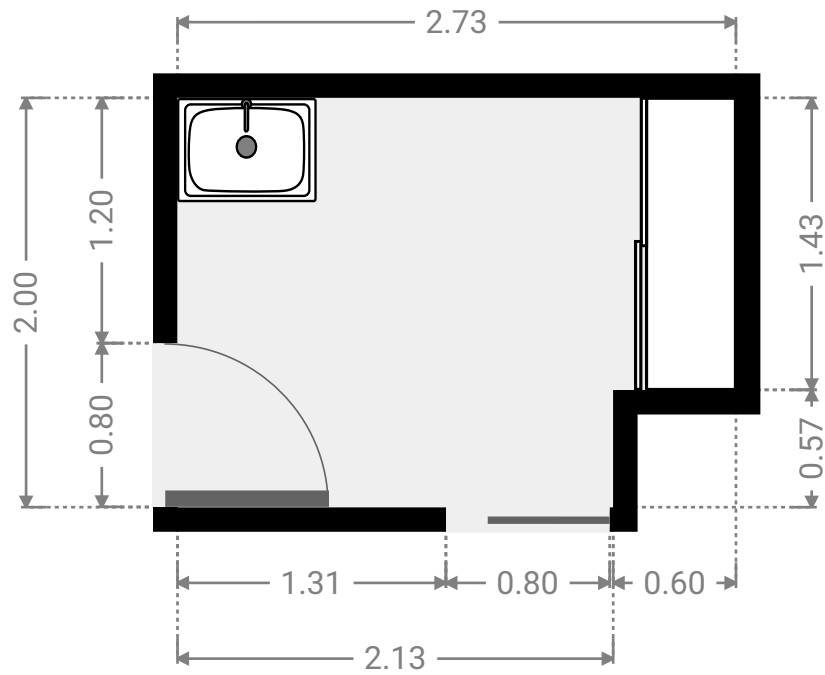
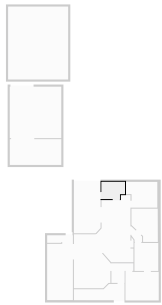

▼ Closet
Ground Floor

WIDTH: 0.25 m • LENGTH: 1.21 m
AREA: 0.26 m² • PERIMETER: 2.74 m

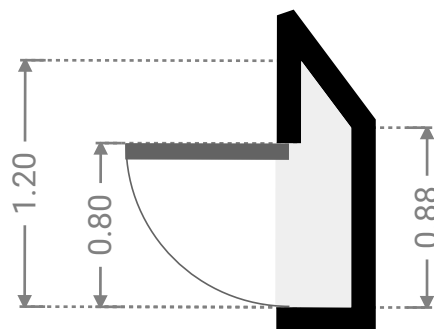
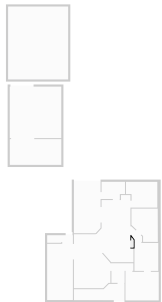

▼ Kitchen
Ground Floor

WIDTH: 4.30 m • LENGTH: 7.83 m
AREA: 25.56 m² • PERIMETER: 22.68 m

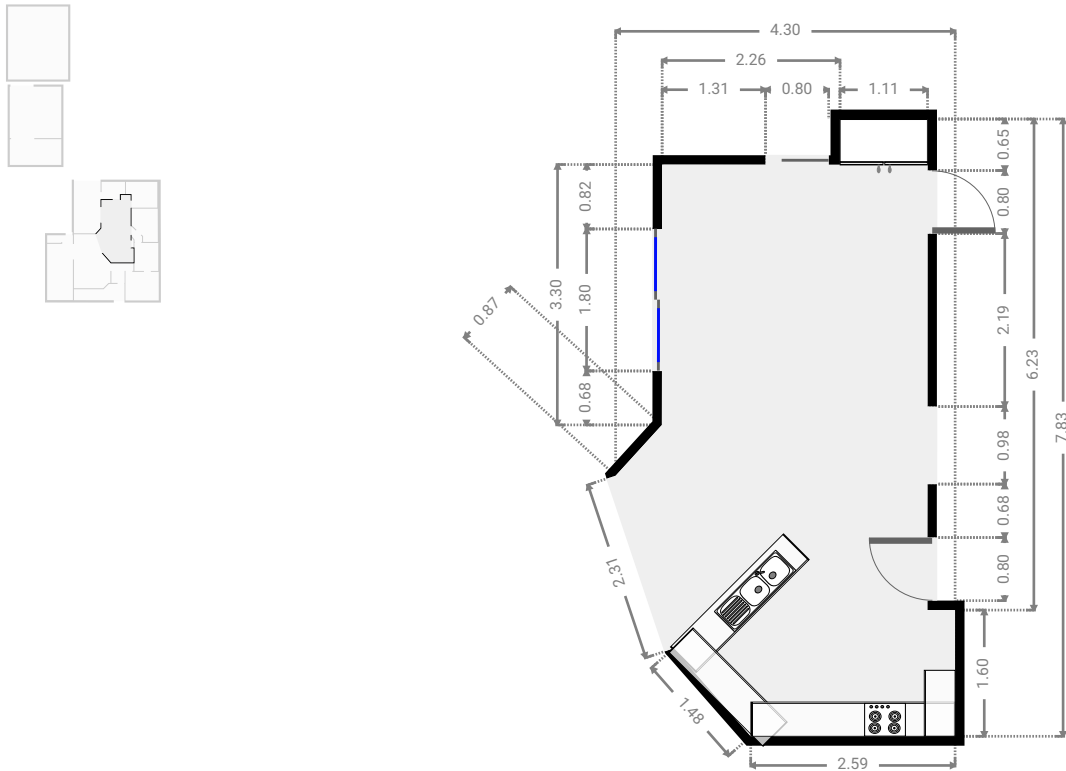

▼ Hall
Ground Floor

WIDTH: 1.24 m • LENGTH: 1.81 m
AREA: 1.33 m² • PERIMETER: 5.15 m

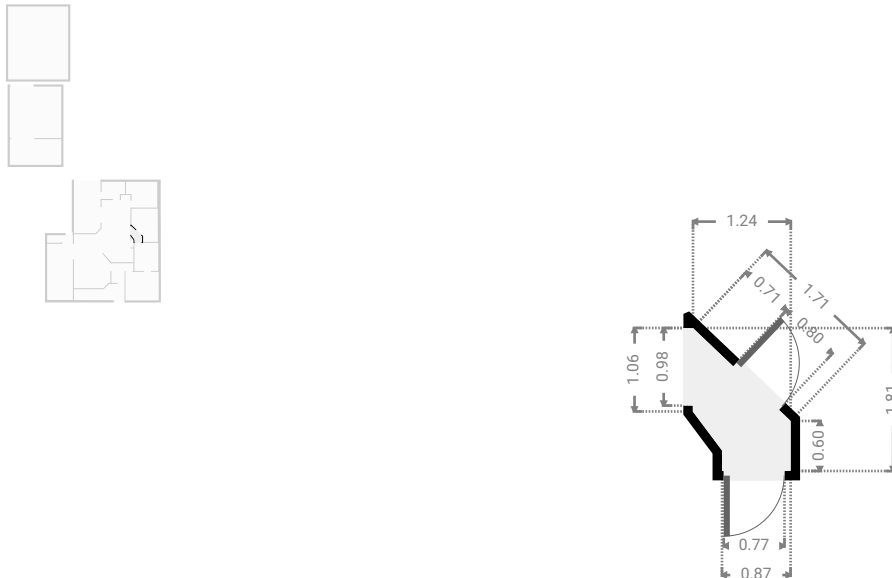

▼ Living Room
Ground Floor

WIDTH: 4.26 m • LENGTH: 6.29 m
AREA: 22.85 m² • PERIMETER: 19.48 m

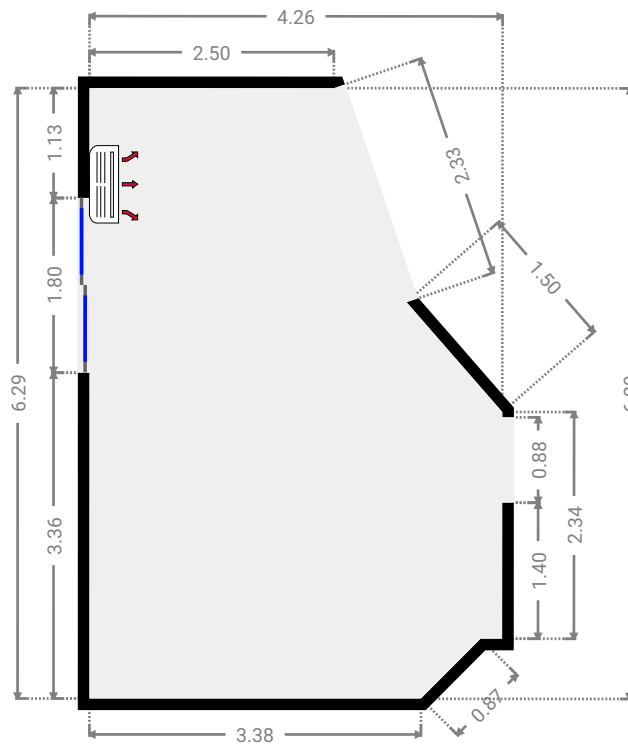
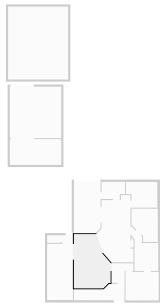

▼ Bathroom
Ground Floor

WIDTH: 2.78 m • LENGTH: 3.26 m
AREA: 9.05 m² • PERIMETER: 12.07 m

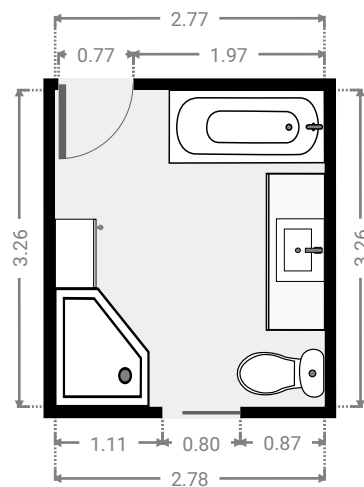

▼ Master Bedroom
Ground Floor

WIDTH: 3.88 m • LENGTH: 3.33 m
AREA: 12.91 m² • PERIMETER: 14.41 m

