

# 47 Heath Street Wandal

## Ground Floor

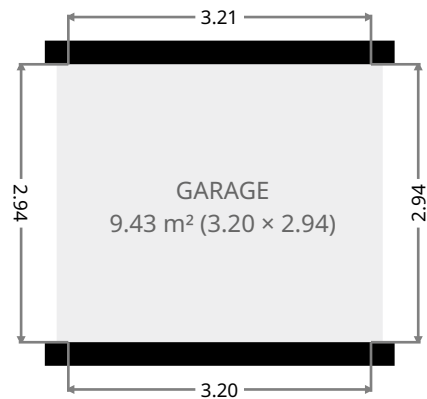

THIS FLOORPLAN IS PROVIDED WITHOUT WARRANTY OF ANY KIND. SENSOPIA DISCLAIMS ANY WARRANTY INCLUDING, WITHOUT LIMITATION, SATISFACTORY QUALITY OR ACCURACY OF DIMENSIONS.

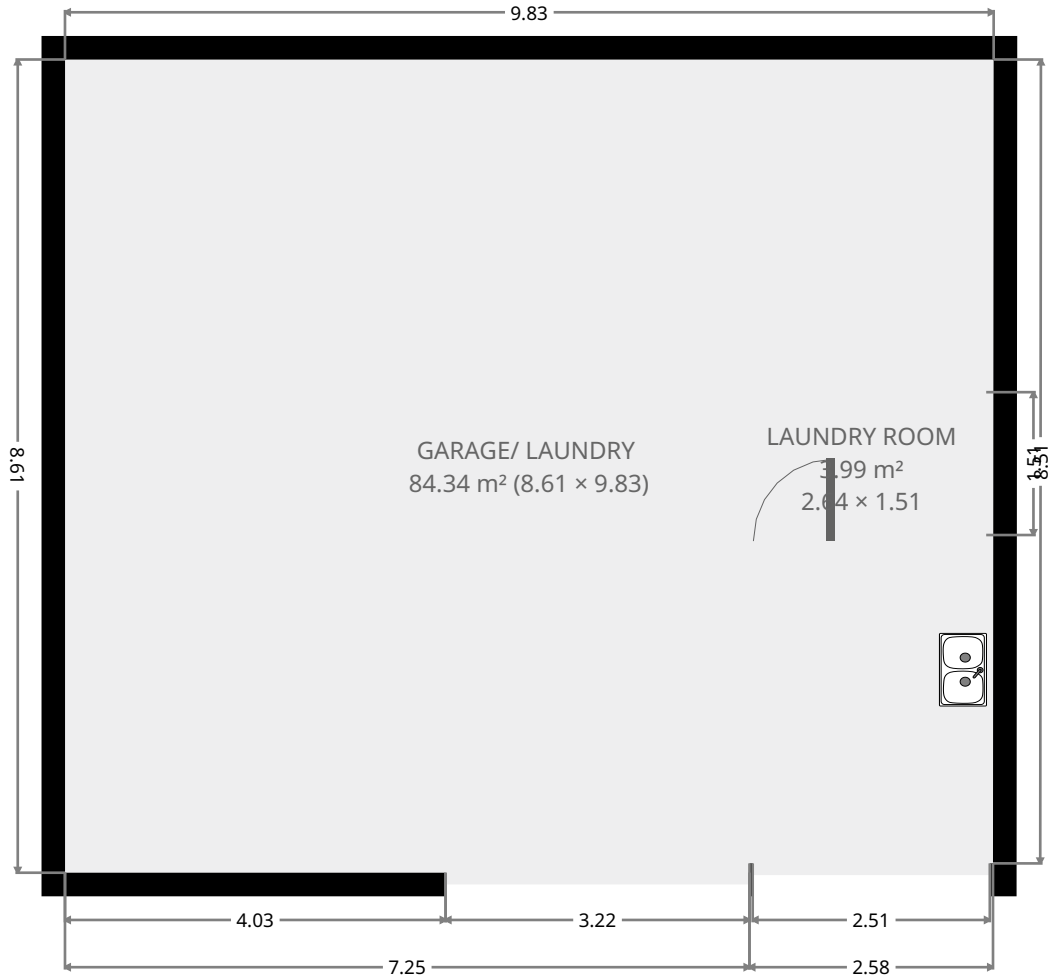
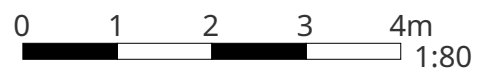

# 47 Heath Street Wandal

## Garage/ laundry

Width: 8.61 m  
 Length: 9.83 m  
 Area: 84.34 m<sup>2</sup>  
 Perimeter: 36.87 m  
 Ceiling Height: 2.65 m

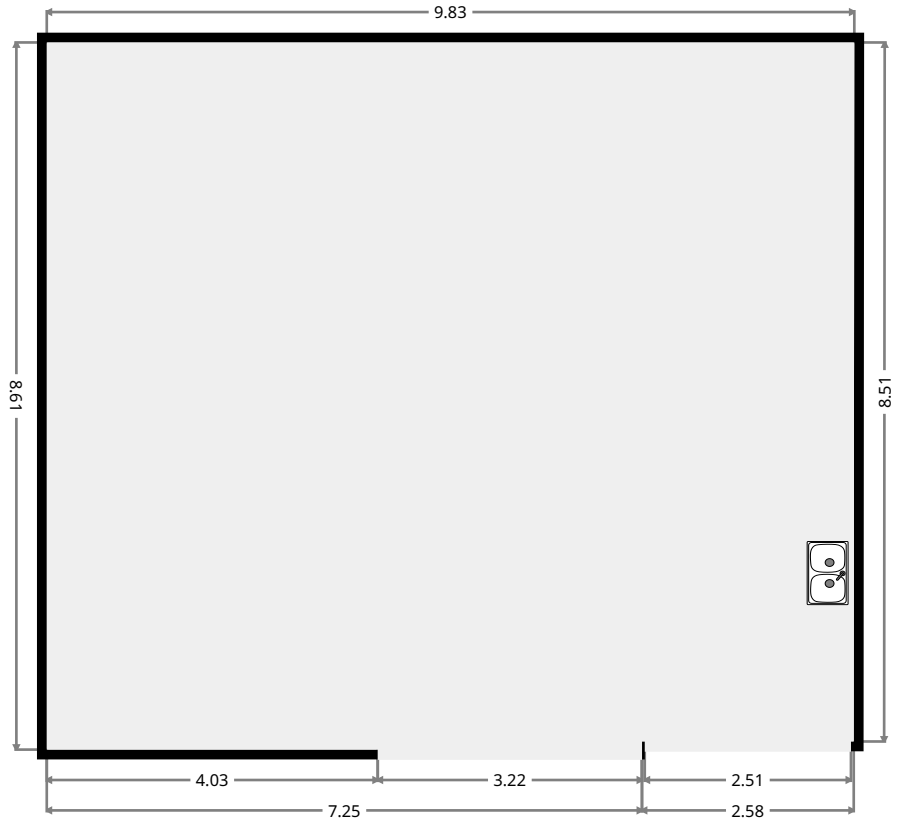
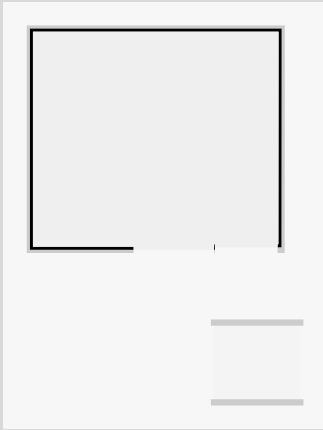

## Laundry Room

Width: 1.51 m  
 Length: 2.64 m  
 Area: 3.99 m<sup>2</sup>  
 Perimeter: 8.30 m

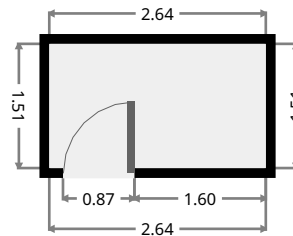
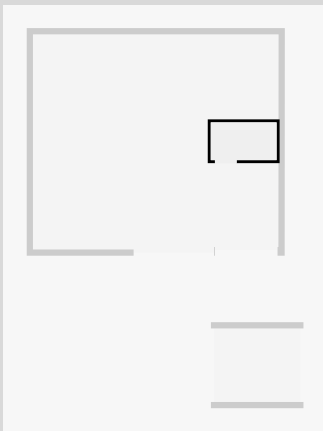

# 47 Heath Street Wandal

## Garage

Width: 2.94 m  
Length: 3.20 m  
Area: 9.43 m<sup>2</sup>  
Perimeter: 12.29 m

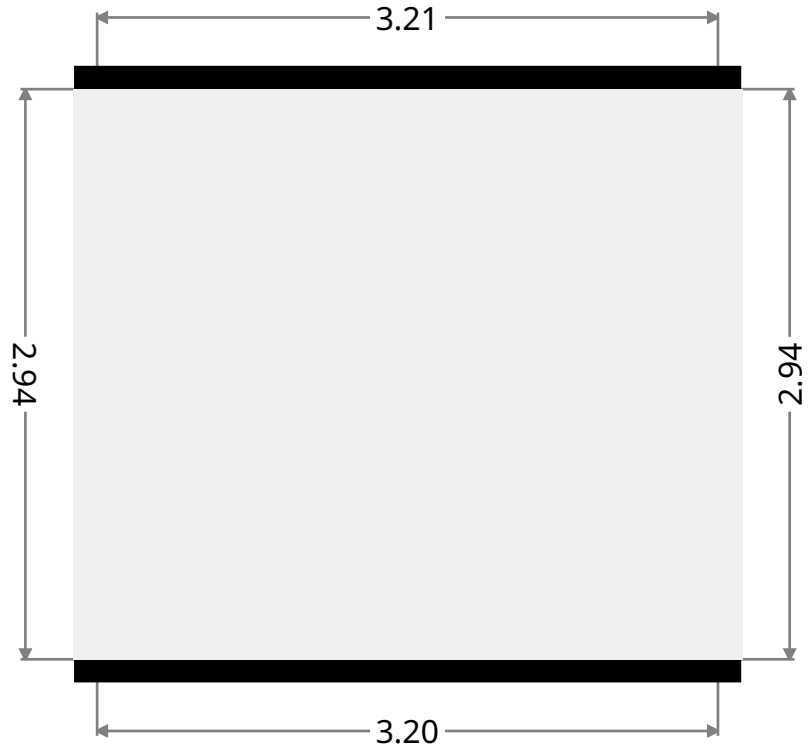
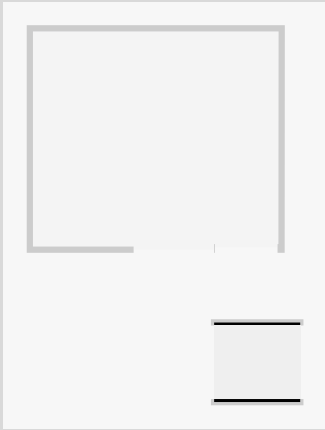

# 47 Heath Street Wandal

## 1st Floor

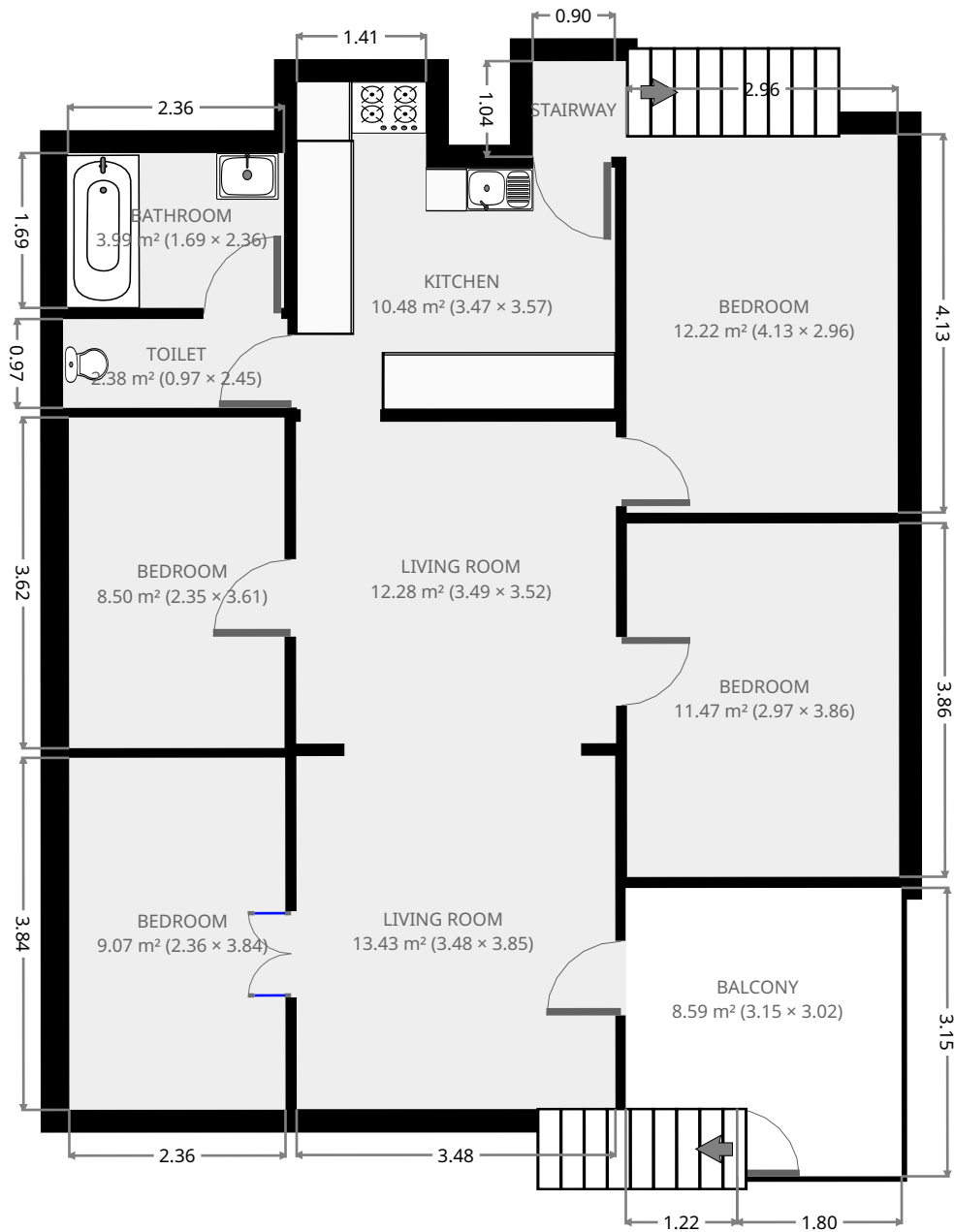

THIS FLOORPLAN IS PROVIDED WITHOUT WARRANTY OF ANY KIND. SENSOPIA DISCLAIMS ANY WARRANTY INCLUDING, WITHOUT LIMITATION, SATISFACTORY QUALITY OR ACCURACY OF DIMENSIONS.

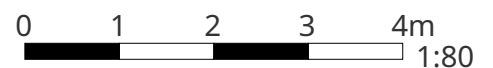

# 47 Heath Street Wandal

## Living Room

Width: 3.48 m  
 Length: 3.85 m  
 Area: 13.43 m<sup>2</sup>  
 Perimeter: 14.68 m  
 Ceiling Height: 2.65 m

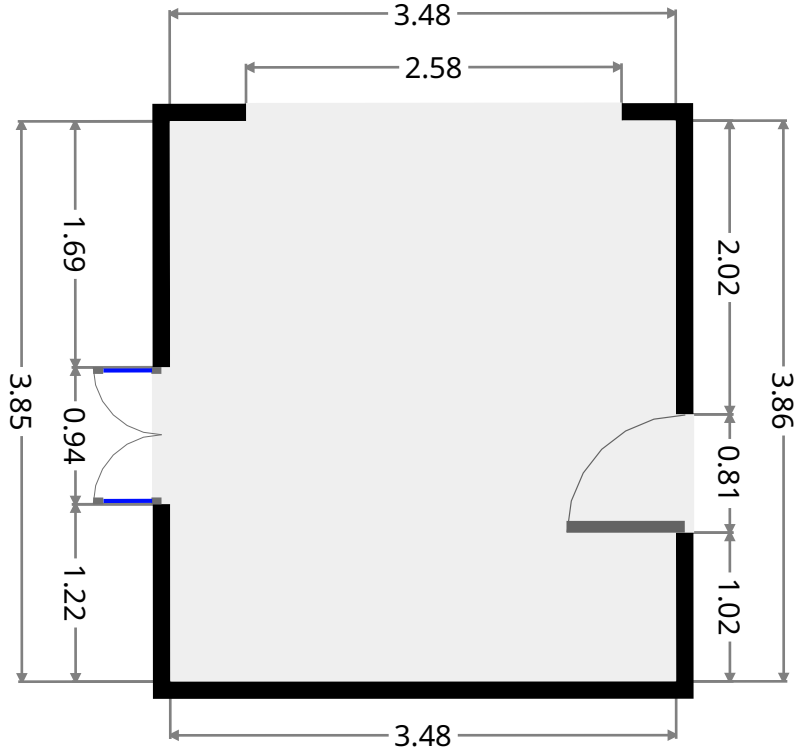
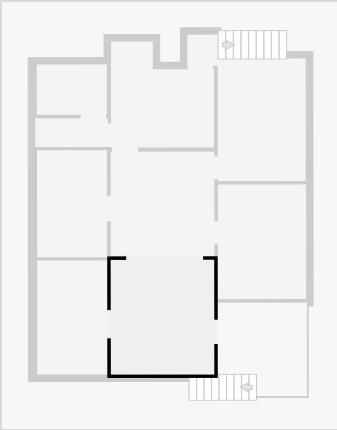

## Living Room

Width: 3.49 m  
 Length: 3.52 m  
 Area: 12.28 m<sup>2</sup>  
 Perimeter: 14.01 m  
 Ceiling Height: 2.65 m

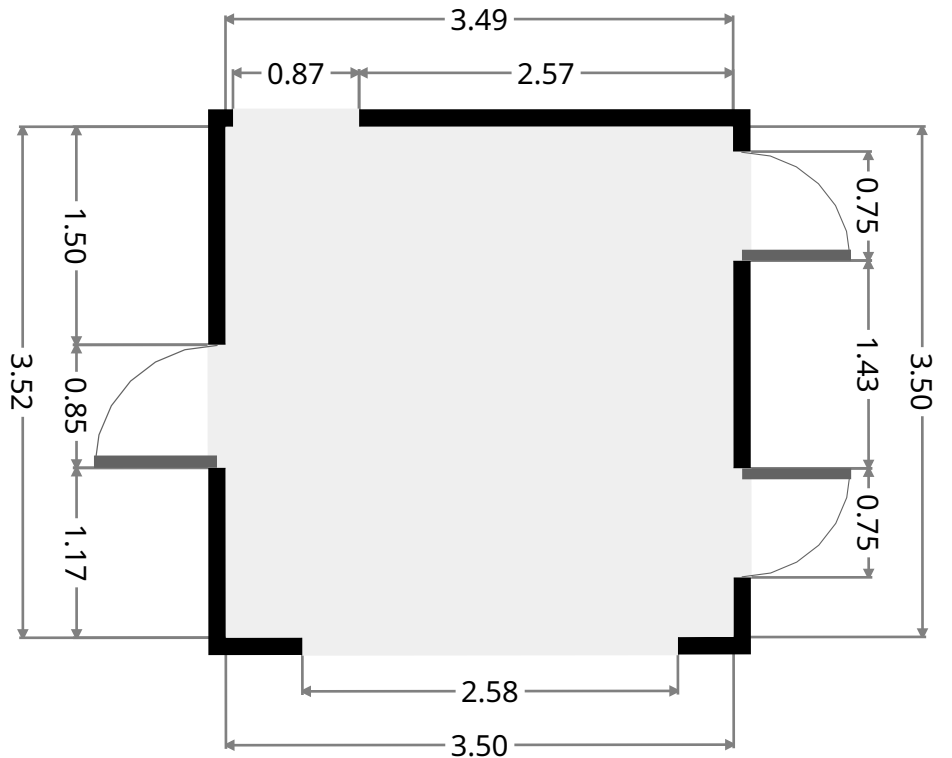
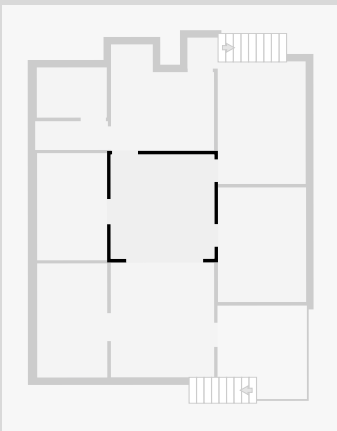

THIS FLOORPLAN IS PROVIDED WITHOUT WARRANTY OF ANY KIND. SENSOPIA DISCLAIMS ANY WARRANTY INCLUDING, WITHOUT LIMITATION, SATISFACTORY QUALITY OR ACCURACY OF DIMENSIONS.

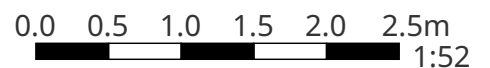

# 47 Heath Street Wandal

## Bedroom

Width: 2.36 m  
 Length: 3.84 m  
 Area: 9.07 m<sup>2</sup>  
 Perimeter: 12.41 m  
 Ceiling Height: 2.65 m

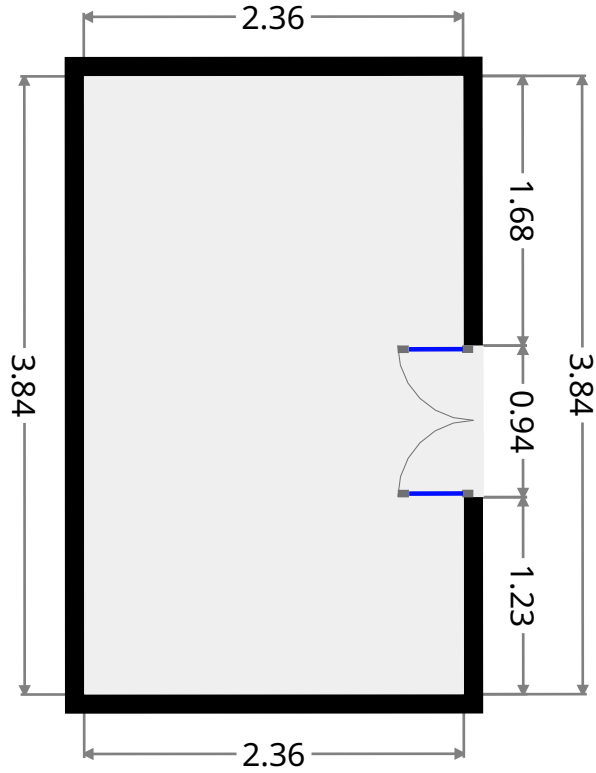
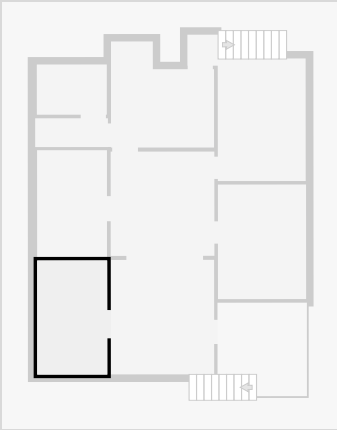

## Bedroom

Width: 2.35 m  
 Length: 3.61 m  
 Area: 8.50 m<sup>2</sup>  
 Perimeter: 11.93 m  
 Ceiling Height: 2.65 m

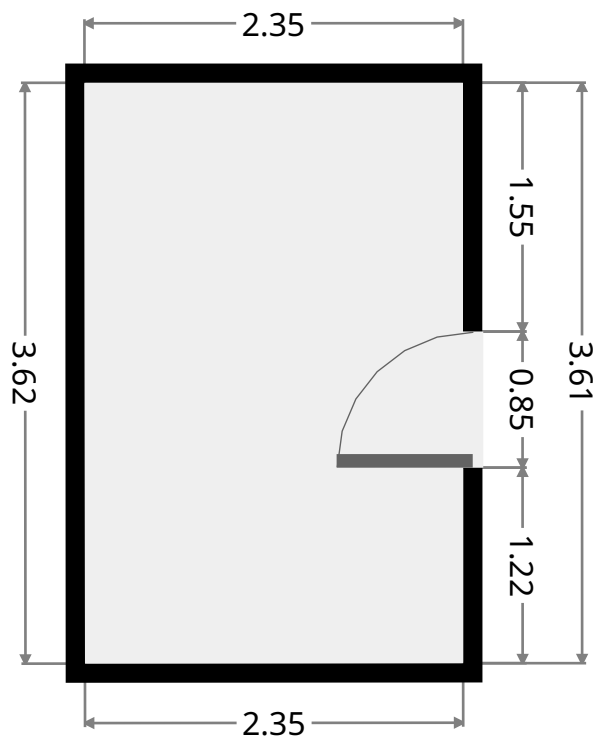
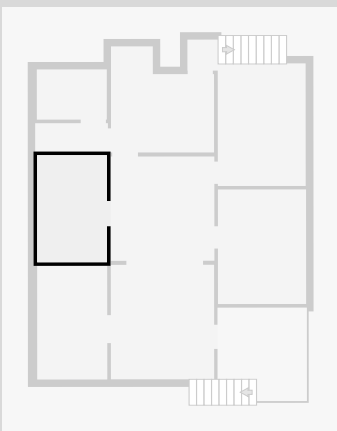

# 47 Heath Street Wandal

## Bedroom

Width: 2.97 m  
Length: 3.86 m  
Area: 11.47 m<sup>2</sup>  
Perimeter: 13.66 m  
Ceiling Height: 2.65 m

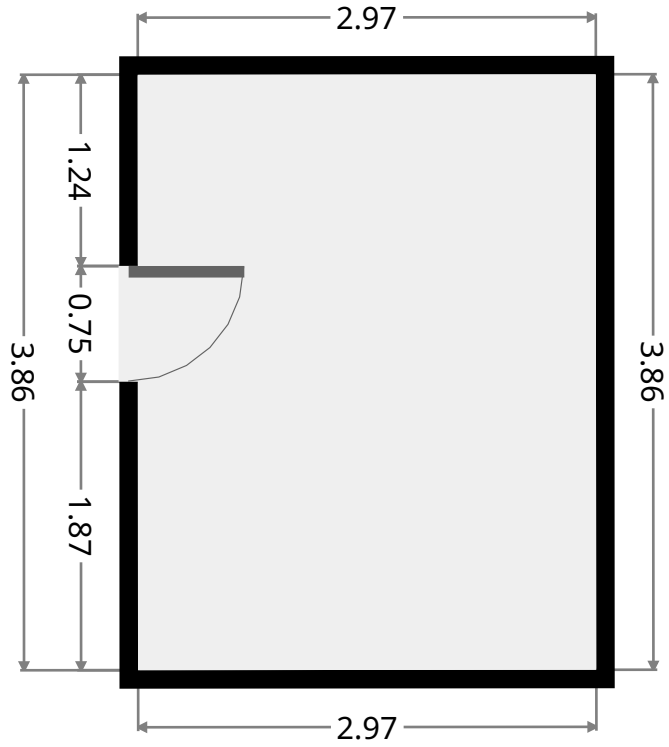
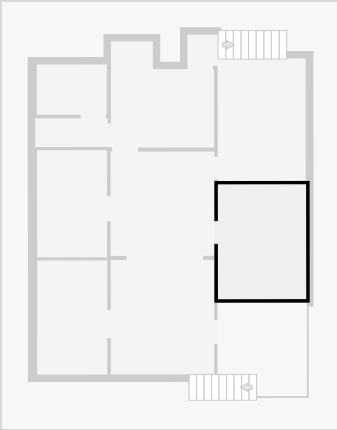

## Bedroom

Width: 2.96 m  
Length: 4.13 m  
Area: 12.22 m<sup>2</sup>  
Perimeter: 14.18 m  
Ceiling Height: 2.65 m

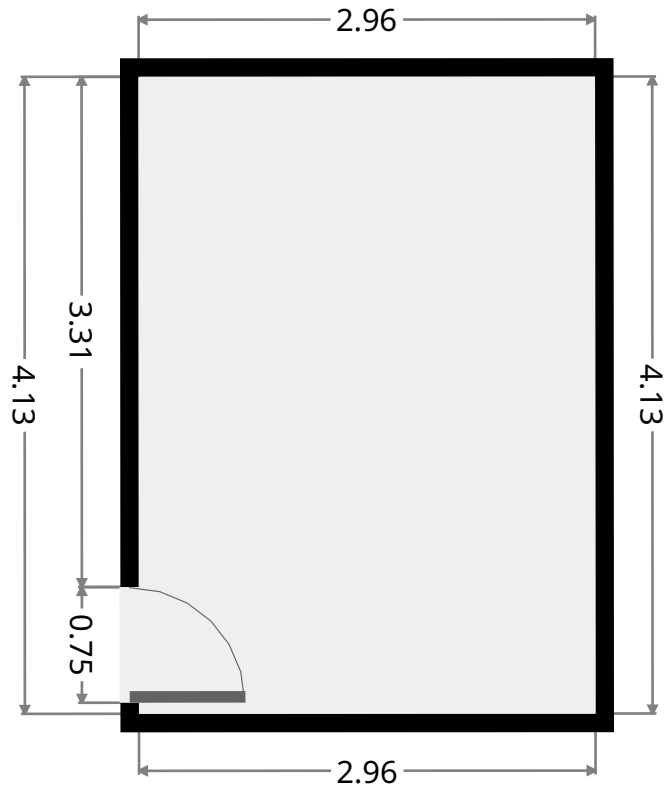
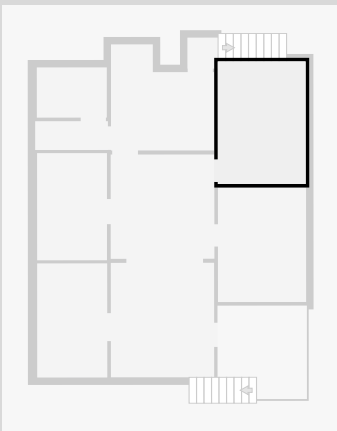

# 47 Heath Street Wandal

## Kitchen

Width: 3.47 m  
 Length: 3.57 m  
 Area: 10.48 m<sup>2</sup>  
 Perimeter: 14.09 m  
 Ceiling Height: 2.65 m

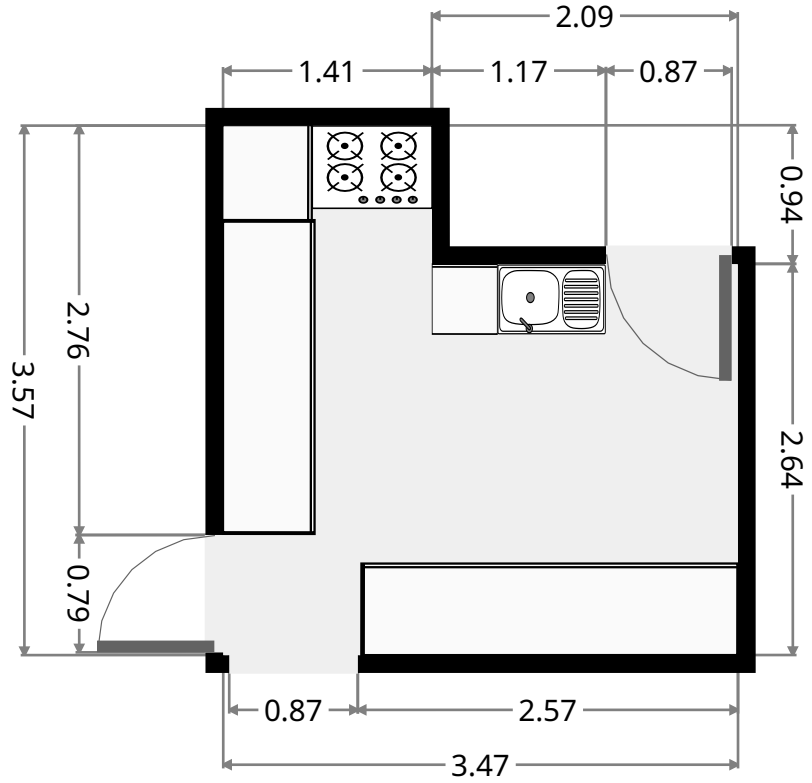
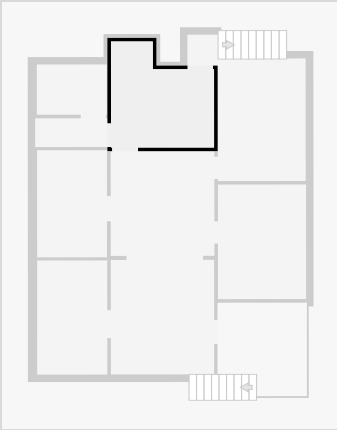

## Toilet

Width: 0.97 m  
 Length: 2.45 m  
 Area: 2.38 m<sup>2</sup>  
 Perimeter: 6.84 m  
 Ceiling Height: 2.65 m

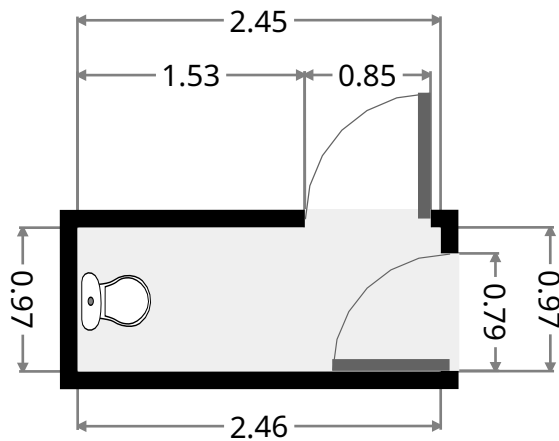
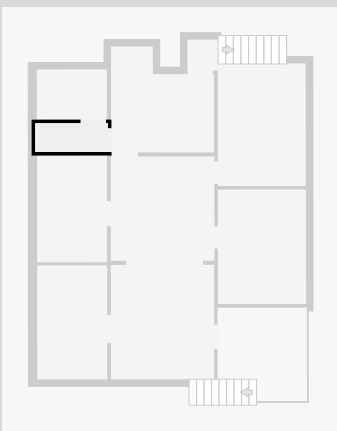



# 47 Heath Street Wandal

## Bathroom

Width: 1.69 m  
Length: 2.36 m  
Area: 3.99 m<sup>2</sup>  
Perimeter: 8.10 m  
Ceiling Height: 2.65 m

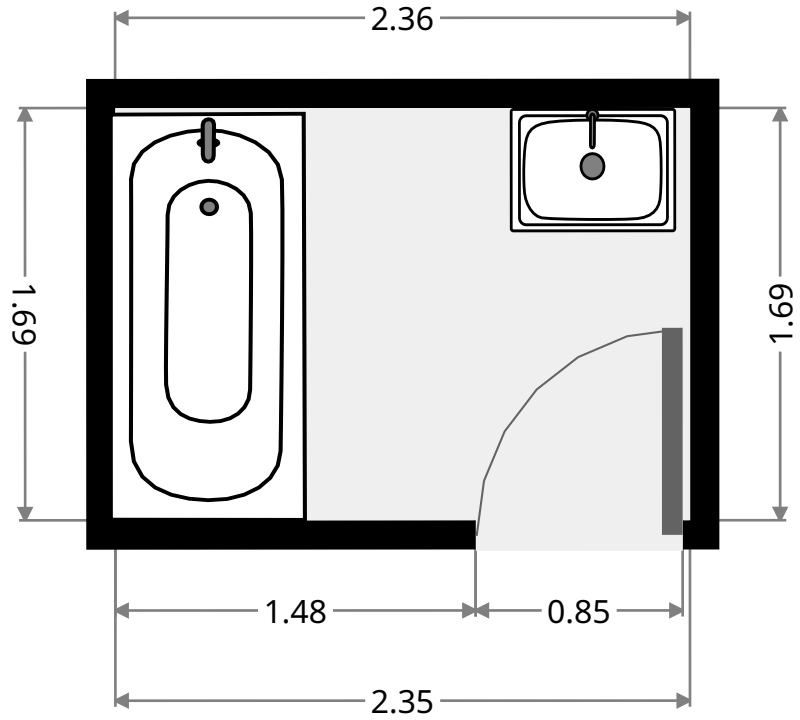
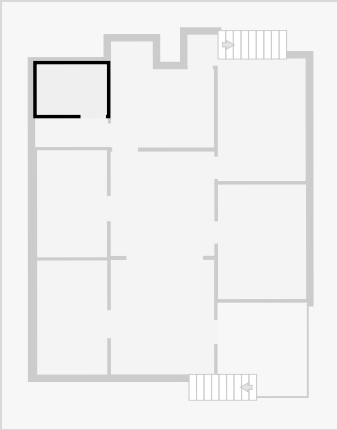

## Stairway

Width: 0.90 m  
Length: 1.05 m  
Area: 0.94 m<sup>2</sup>  
Perimeter: 3.88 m

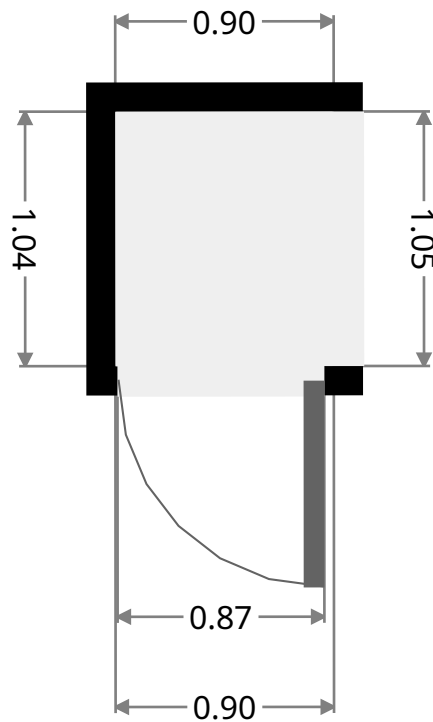
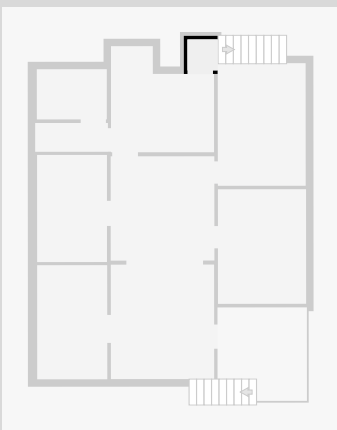

# 47 Heath Street Wandal

## Balcony

Width:	3.02 m
Length:	3.15 m
Area	8.59 m <sup>2</sup>
Perimeter	12.32 m
Ceiling Height:	2.65 m

