

47 Bramble Street

Ground Floor

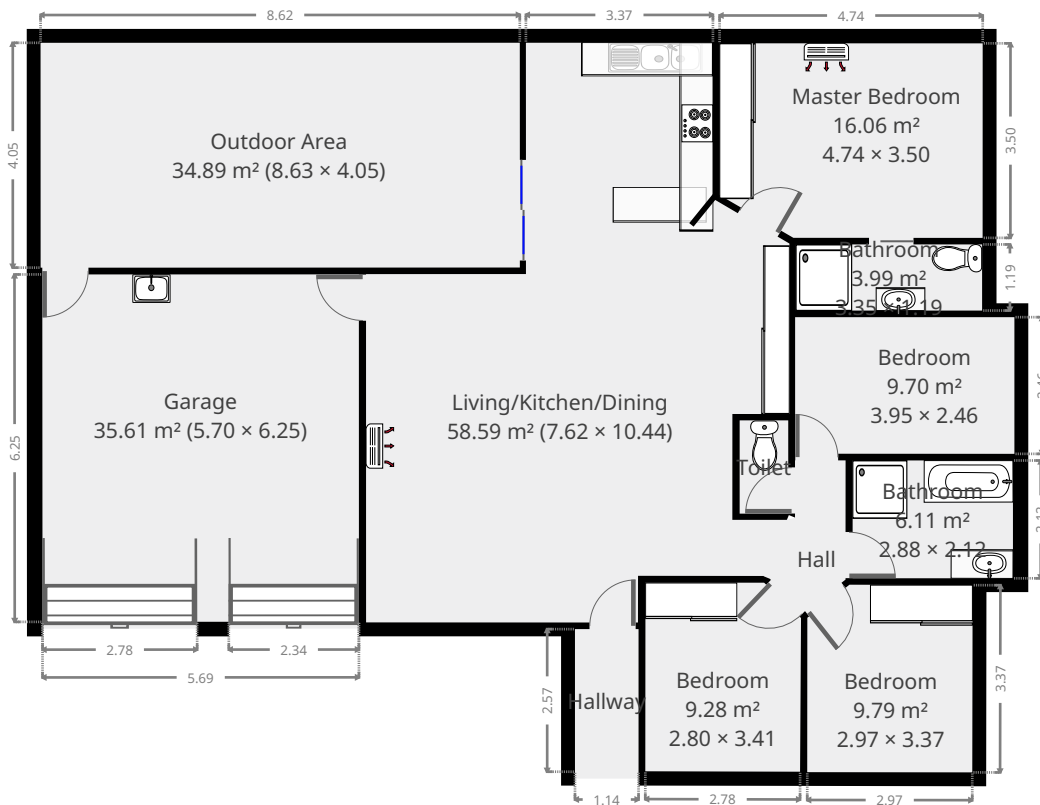

THIS FLOORPLAN IS PROVIDED WITHOUT WARRANTY OF ANY KIND. SENSOPIA DISCLAIMS ANY WARRANTY INCLUDING, WITHOUT LIMITATION, SATISFACTORY QUALITY OR ACCURACY OF DIMENSIONS.

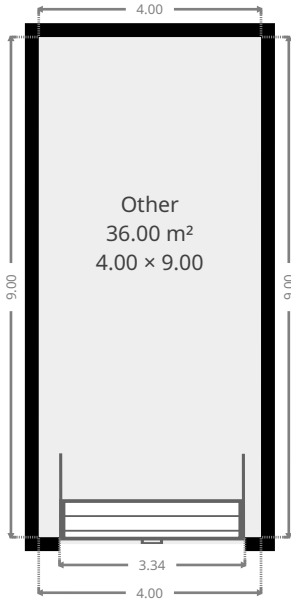

47 Bramble Street

Living/Kitchen/Dining

Width: 7.62 m
Length: 10.44 m
Area: 58.59 m²
Perimeter: 37.15 m

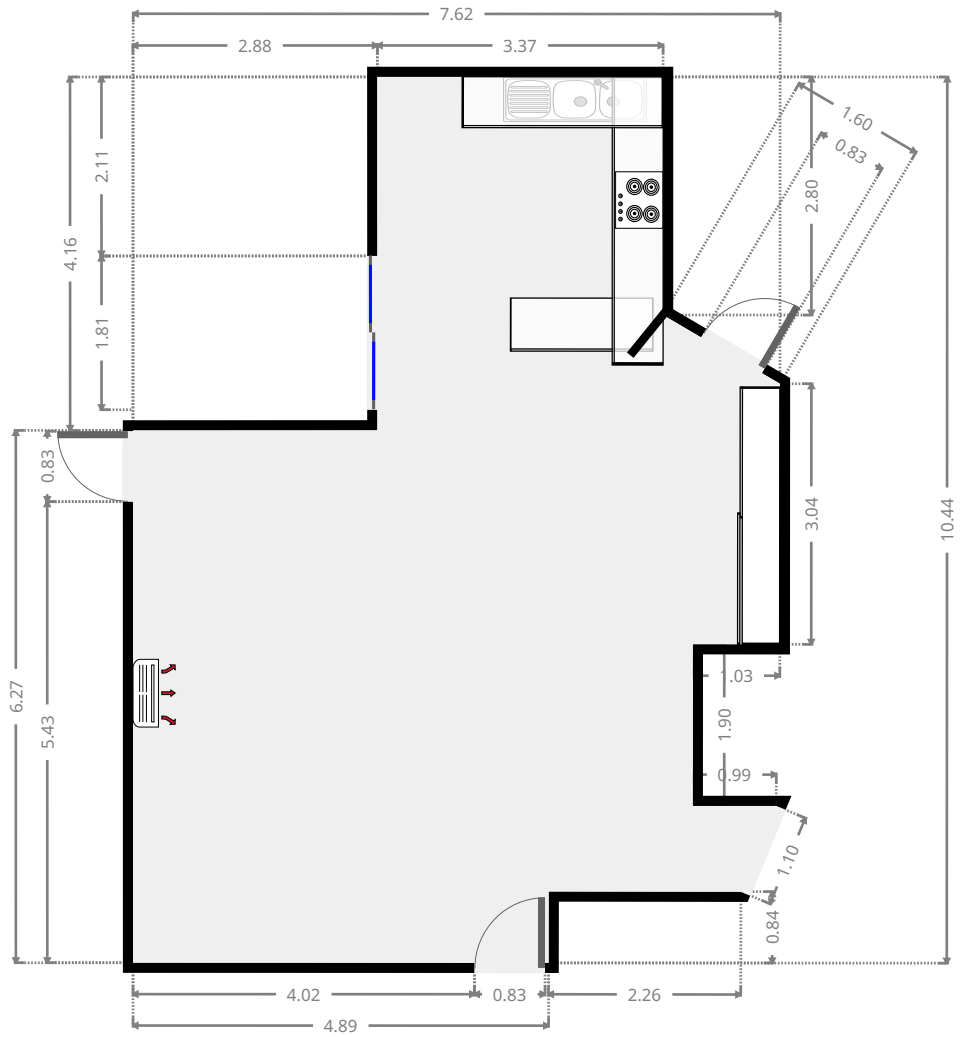
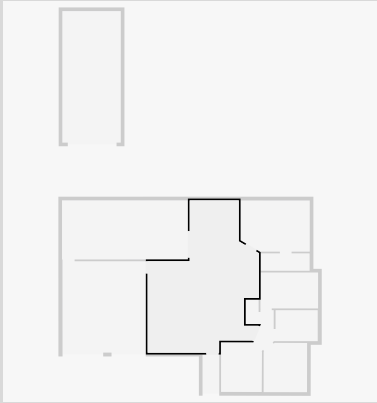

THIS FLOORPLAN IS PROVIDED WITHOUT WARRANTY OF ANY KIND. SENSOPIA DISCLAIMS ANY WARRANTY INCLUDING, WITHOUT LIMITATION, SATISFACTORY QUALITY OR ACCURACY OF DIMENSIONS.



47 Bramble Street

Master Bedroom

Width: 3.50 m
 Length: 4.74 m
 Area: 16.06 m²
 Perimeter: 15.91 m

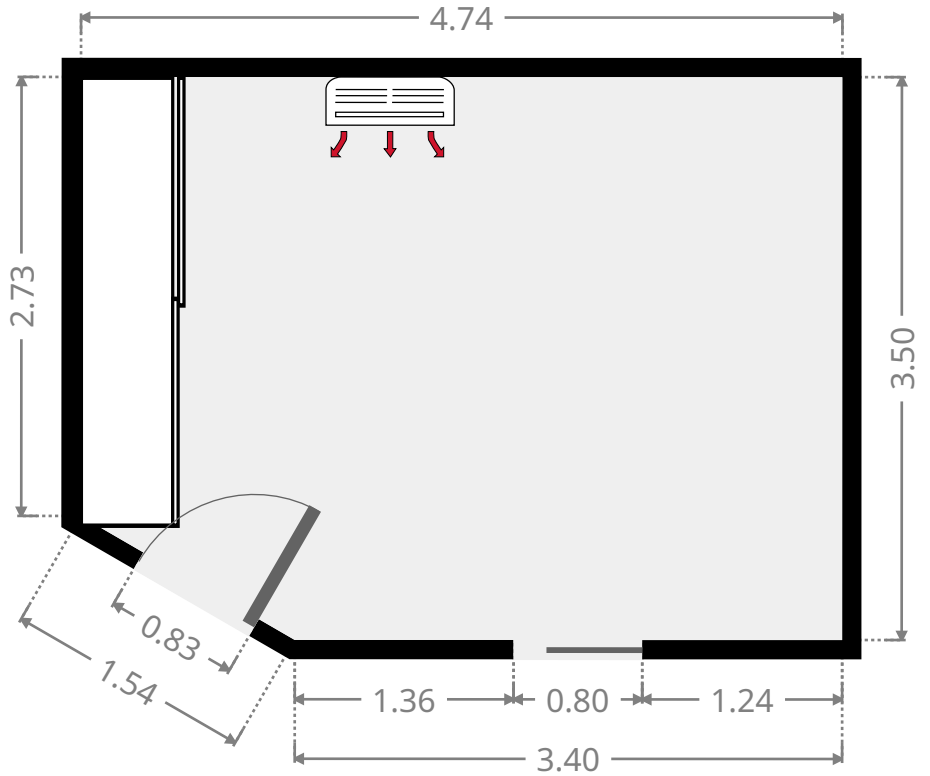
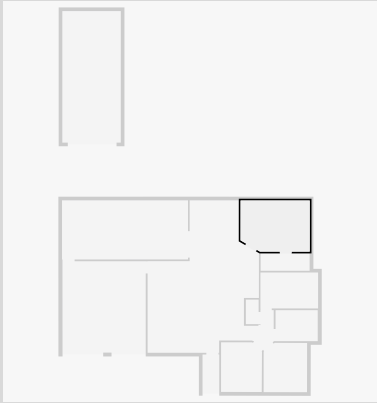

Bathroom

Width: 1.19 m
 Length: 3.35 m
 Area: 3.99 m²
 Perimeter: 9.08 m

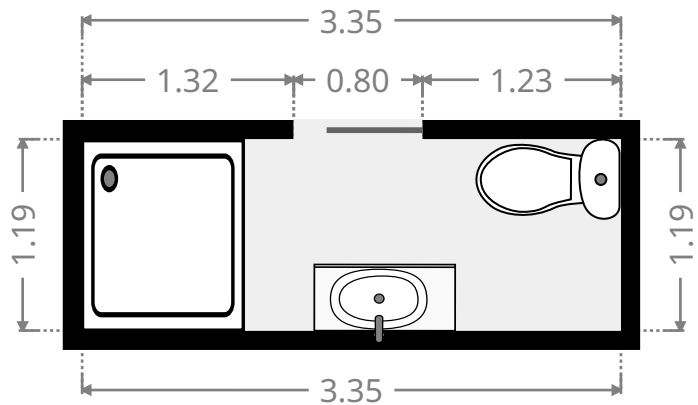
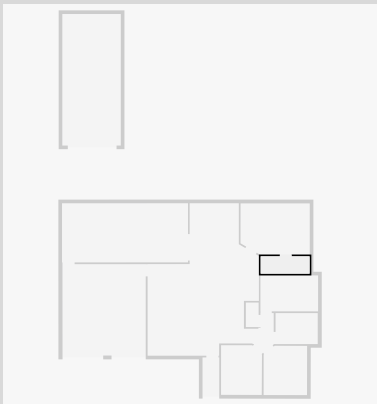

47 Bramble Street

Bedroom

Width: 2.46 m
Length: 3.95 m
Area: 9.70 m²
Perimeter: 12.81 m

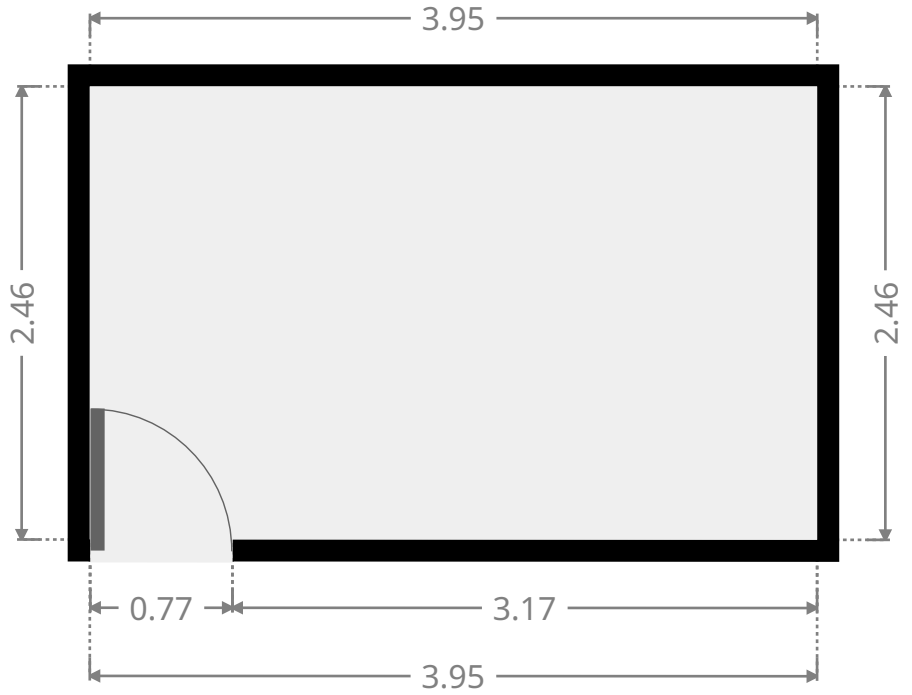
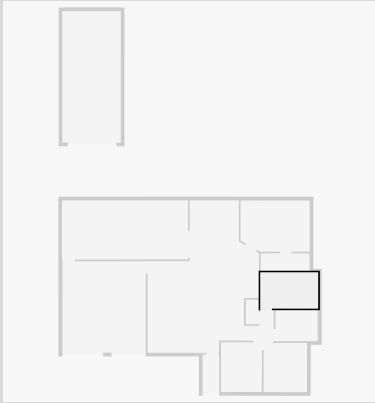

Toilet / Half Bath

Width: 0.87 m
Length: 1.68 m
Area: 1.47 m²
Perimeter: 5.10 m

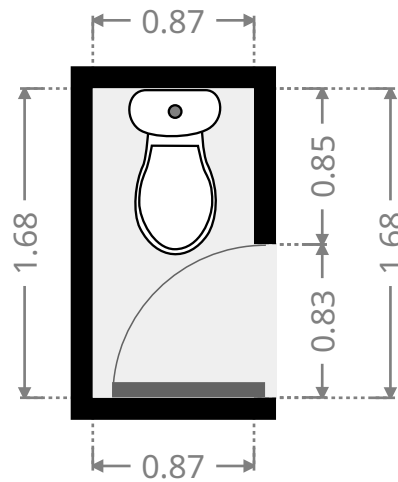
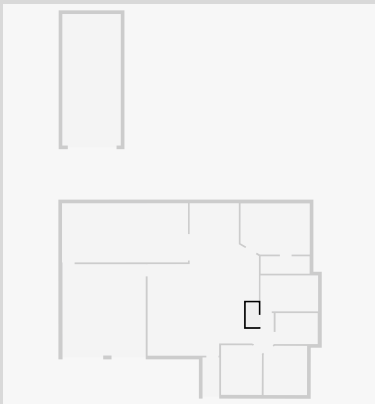

47 Bramble Street

Bedroom

Width: 2.80 m
 Length: 3.41 m
 Area: 9.28 m²
 Perimeter: 12.00 m

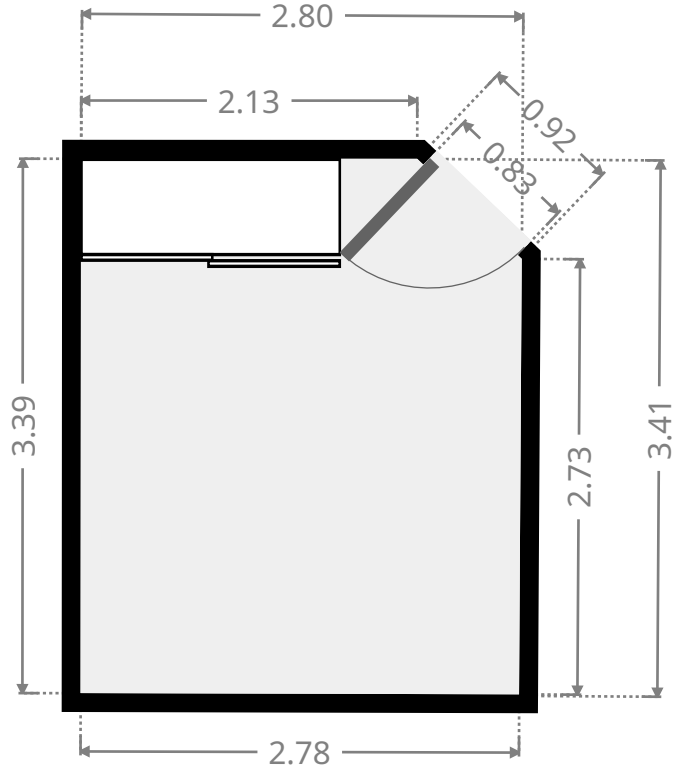
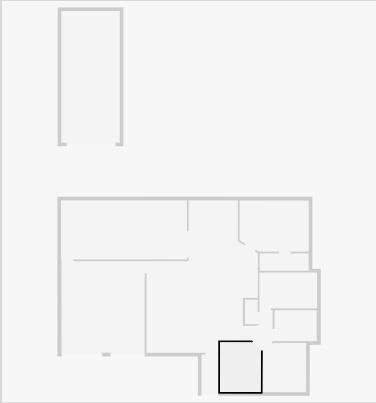

Bedroom

Width: 2.97 m
 Length: 3.37 m
 Area: 9.79 m²
 Perimeter: 12.30 m

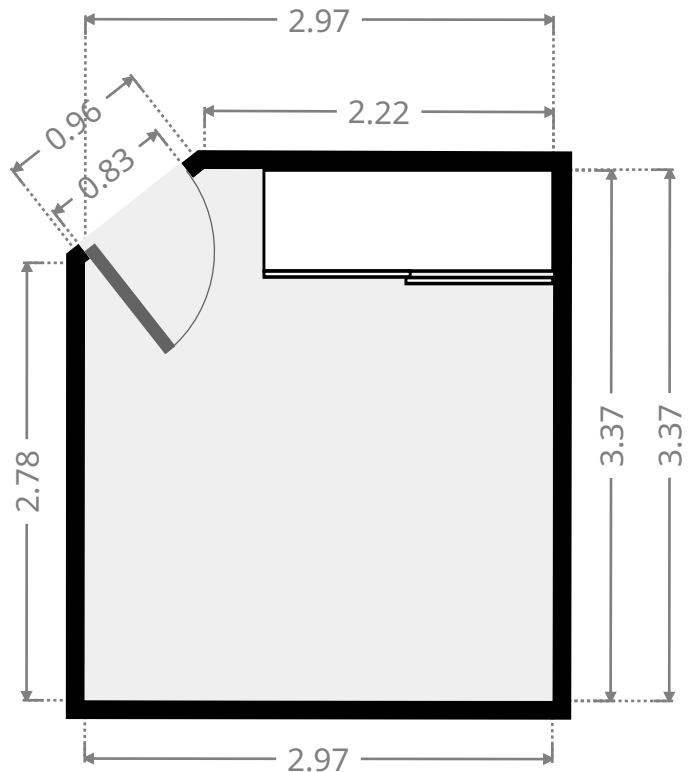
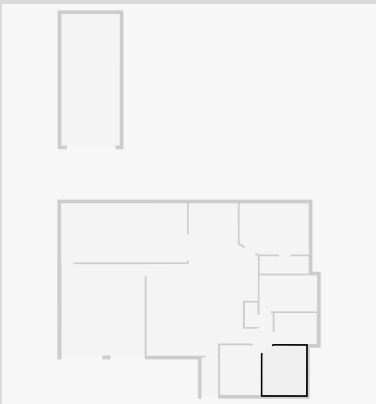

THIS FLOORPLAN IS PROVIDED WITHOUT WARRANTY OF ANY KIND. SENSOPIA DISCLAIMS ANY WARRANTY INCLUDING, WITHOUT LIMITATION, SATISFACTORY QUALITY OR ACCURACY OF DIMENSIONS.

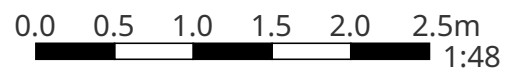

47 Bramble Street

Bathroom

Width: 2.12 m
Length: 2.88 m
Area: 6.11 m²
Perimeter: 10.01 m

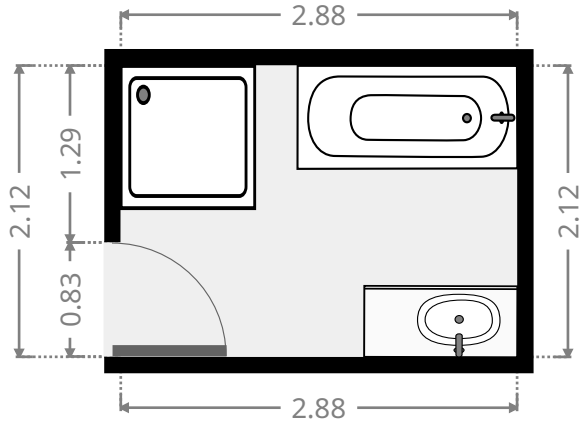
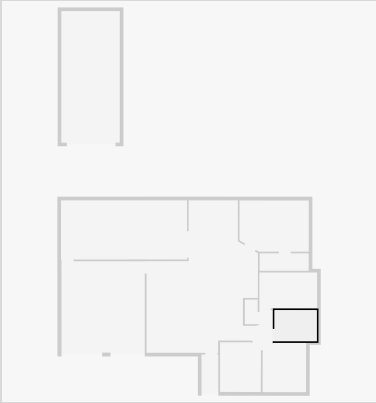

Hall

Width: 1.36 m
Length: 2.73 m
Area: 2.60 m²
Perimeter: 7.08 m

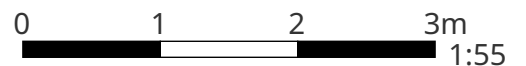
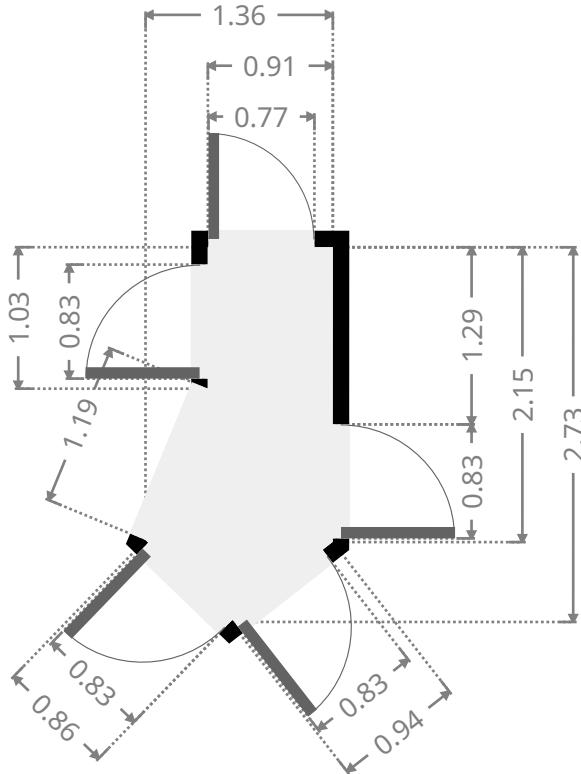
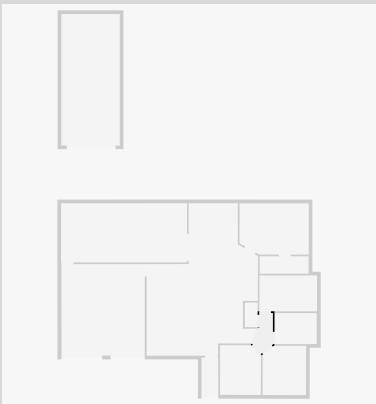

THIS FLOORPLAN IS PROVIDED WITHOUT WARRANTY OF ANY KIND. SENSOPIA DISCLAIMS ANY WARRANTY INCLUDING, WITHOUT LIMITATION, SATISFACTORY QUALITY OR ACCURACY OF DIMENSIONS.

47 Bramble Street

Garage

Width: 5.70 m
 Length: 6.25 m
 Area: 35.61 m²
 Perimeter: 23.90 m

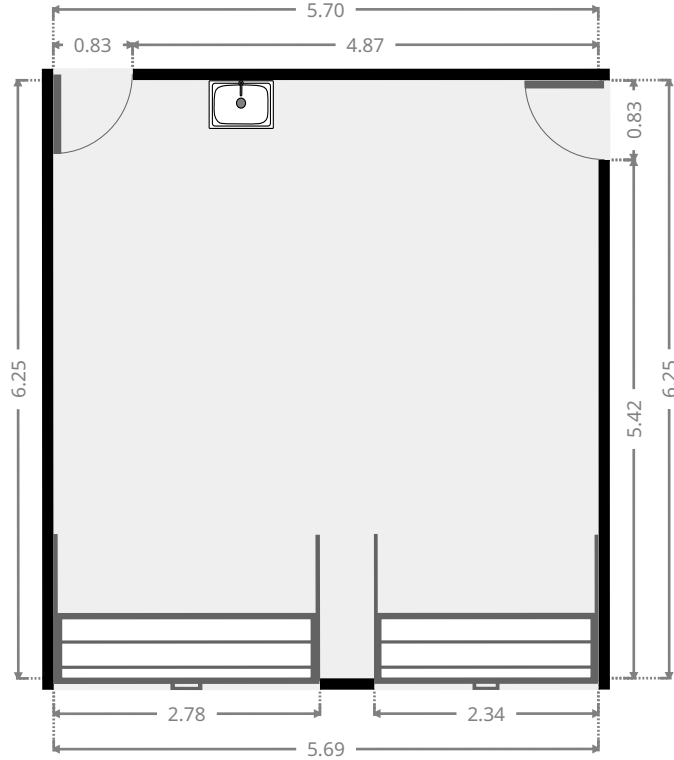
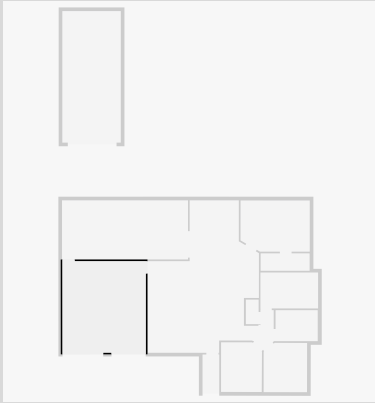

Outdoor Area

Width: 4.05 m
 Length: 8.63 m
 Area: 34.89 m²
 Perimeter: 25.34 m

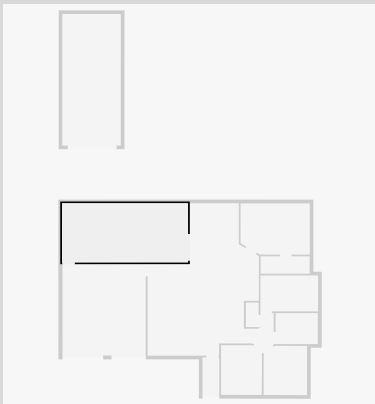

THIS FLOORPLAN IS PROVIDED WITHOUT WARRANTY OF ANY KIND. SENSOPIA DISCLAIMS ANY WARRANTY INCLUDING, WITHOUT LIMITATION, SATISFACTORY QUALITY OR ACCURACY OF DIMENSIONS.



47 Bramble Street

Other

Width: 4.00 m
Length: 9.00 m
Area: 36.00 m²
Perimeter: 26.00 m

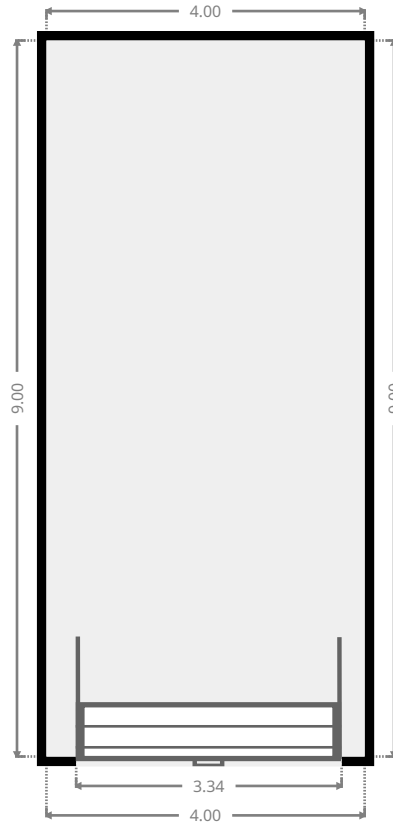
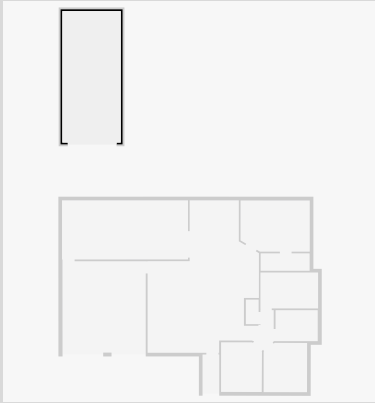

Hallway

Width: 1.14 m
Length: 2.57 m
Area: 2.94 m²
Perimeter: 7.42 m

