

# 45 Woodville Street

Created on  
2020-08-25

Floors  
1

## ▼ Ground Floor

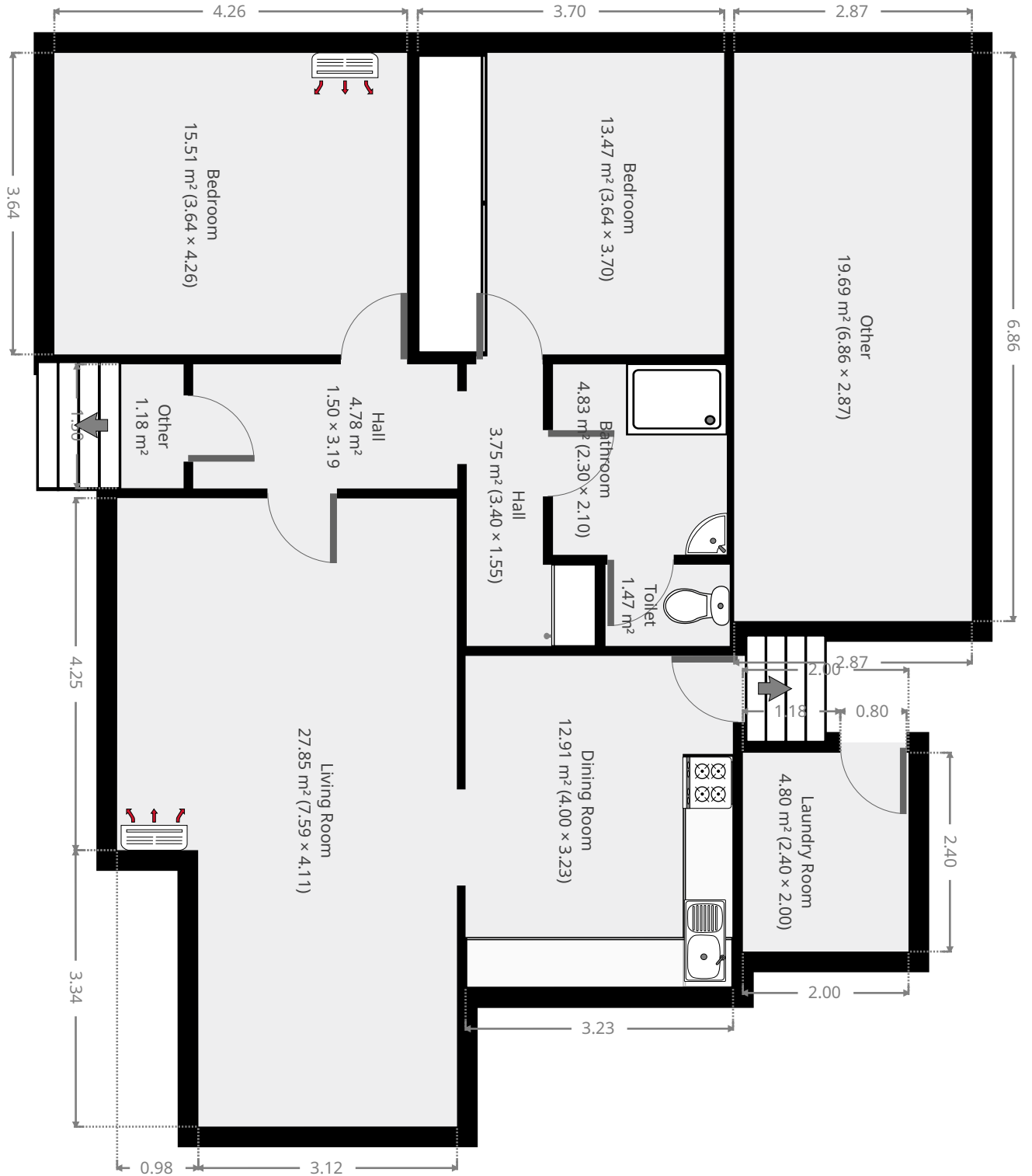

THIS FLOORPLAN IS PROVIDED WITHOUT WARRANTY OF ANY KIND. SENSOPIA DISCLAIMS ANY WARRANTY INCLUDING, WITHOUT LIMITATION, SATISFACTORY QUALITY OR ACCURACY OF DIMENSIONS.

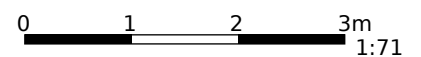

FLOORS: 1

▼ **Hall**  
Ground Floor

WIDTH: 1.50 m • LENGTH: 3.19 m  
AREA: 4.78 m<sup>2</sup> • PERIMETER: 9.38 m

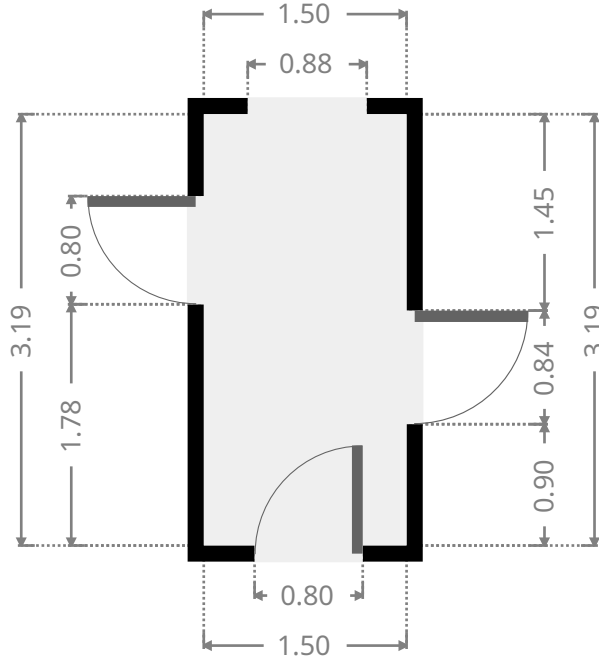

▼ **Bedroom**  
Ground Floor

WIDTH: 3.64 m • LENGTH: 4.26 m  
AREA: 15.51 m<sup>2</sup> • PERIMETER: 15.80 m

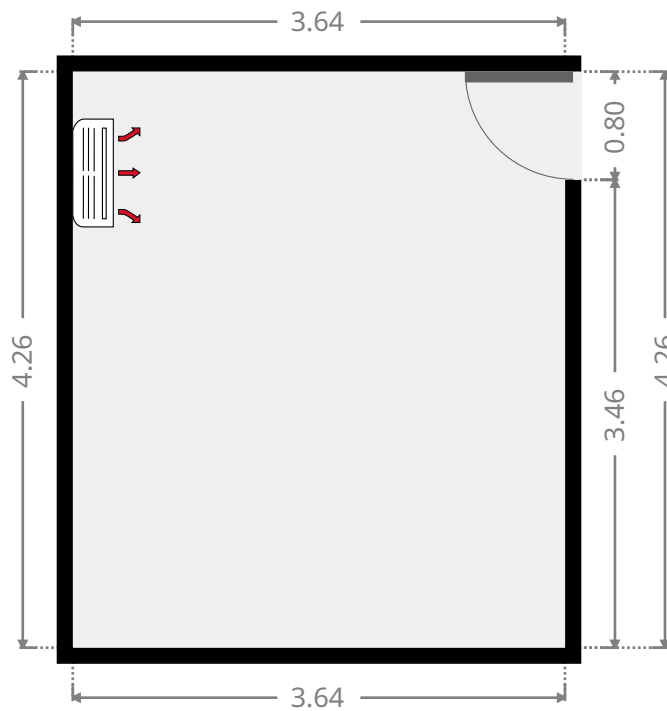

FLOORS: 1

▼ **Hall**  
Ground Floor

WIDTH: 3.40 m • LENGTH: 1.55 m  
AREA: 3.75 m<sup>2</sup> • PERIMETER: 9.91 m

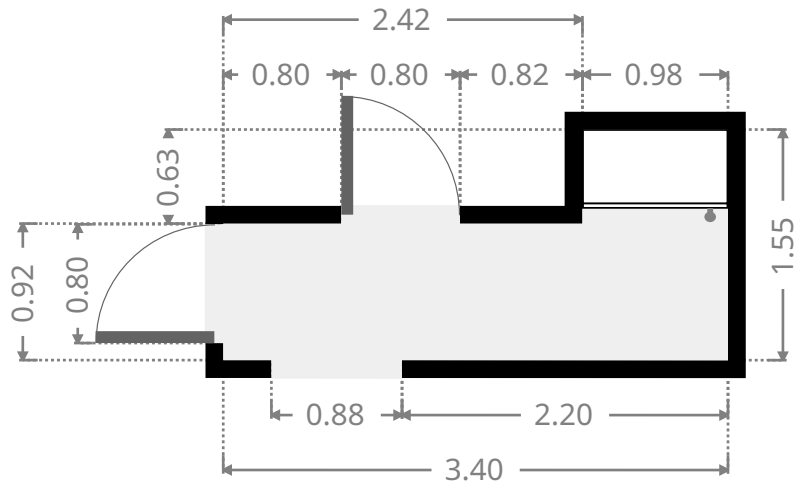
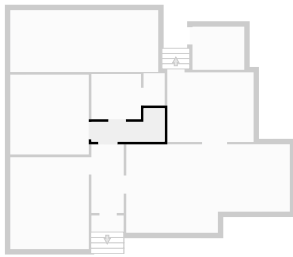

▼ **Bedroom**  
Ground Floor

WIDTH: 3.64 m • LENGTH: 3.70 m  
AREA: 13.47 m<sup>2</sup> • PERIMETER: 14.68 m

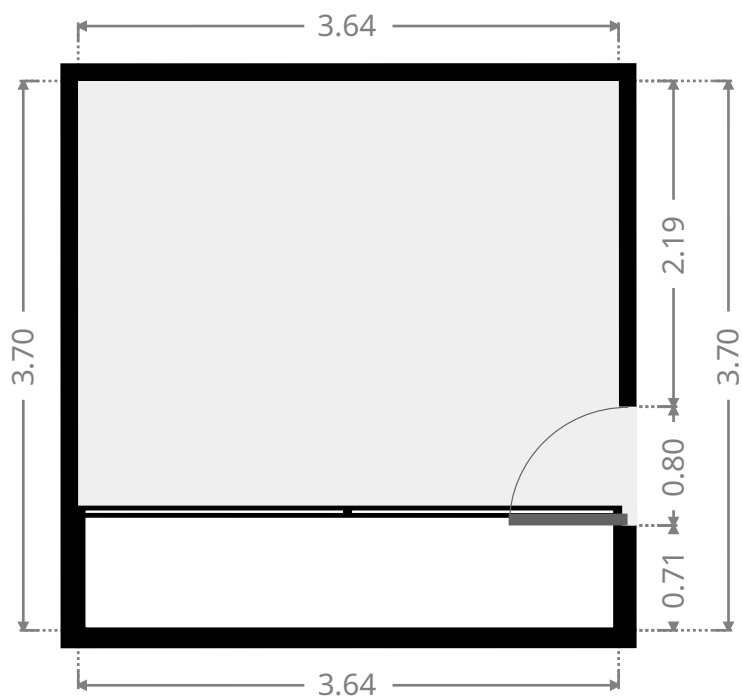
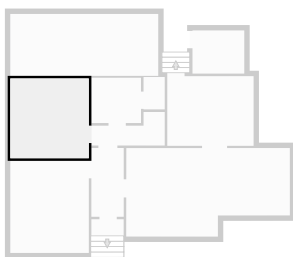

▼ **Bathroom**  
Ground Floor

WIDTH: 2.30 m • LENGTH: 2.10 m  
AREA: 4.83 m<sup>2</sup> • PERIMETER: 8.80 m

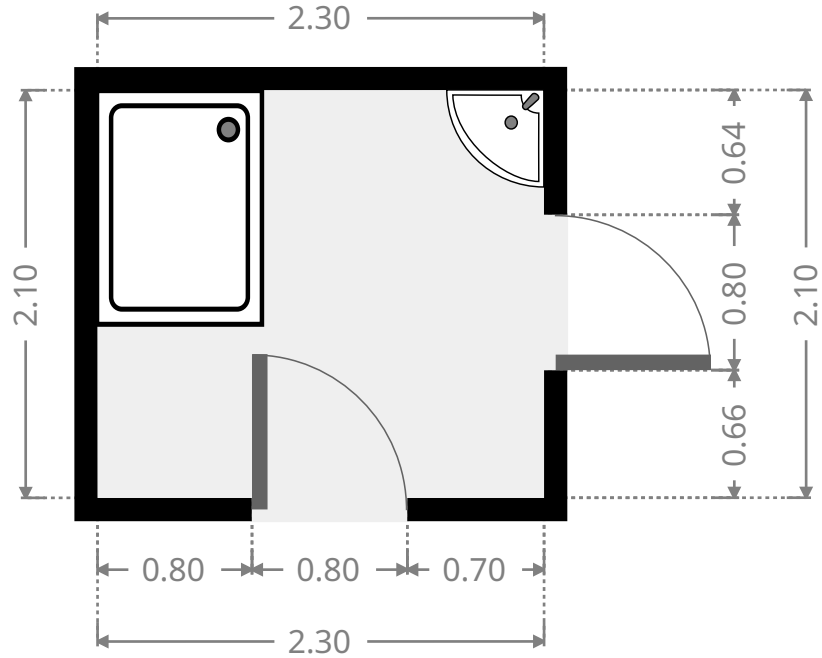
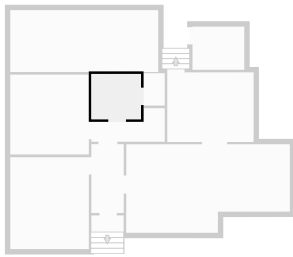

▼ **Toilet**  
Ground Floor

WIDTH: 0.98 m • LENGTH: 1.50 m  
AREA: 1.47 m<sup>2</sup> • PERIMETER: 4.96 m

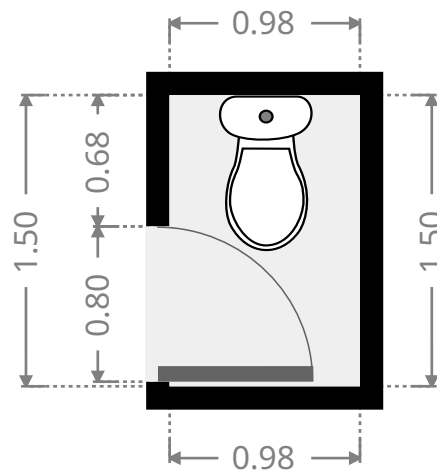
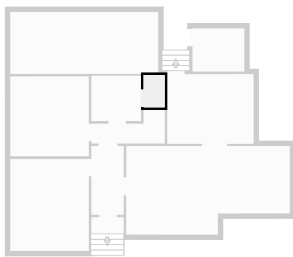

FLOORS: 1

▼ **Living Room**  
Ground Floor

**WIDTH:** 7.59 m • **LENGTH:** 4.11 m  
**AREA:** 27.85 m<sup>2</sup> • **PERIMETER:** 23.37 m

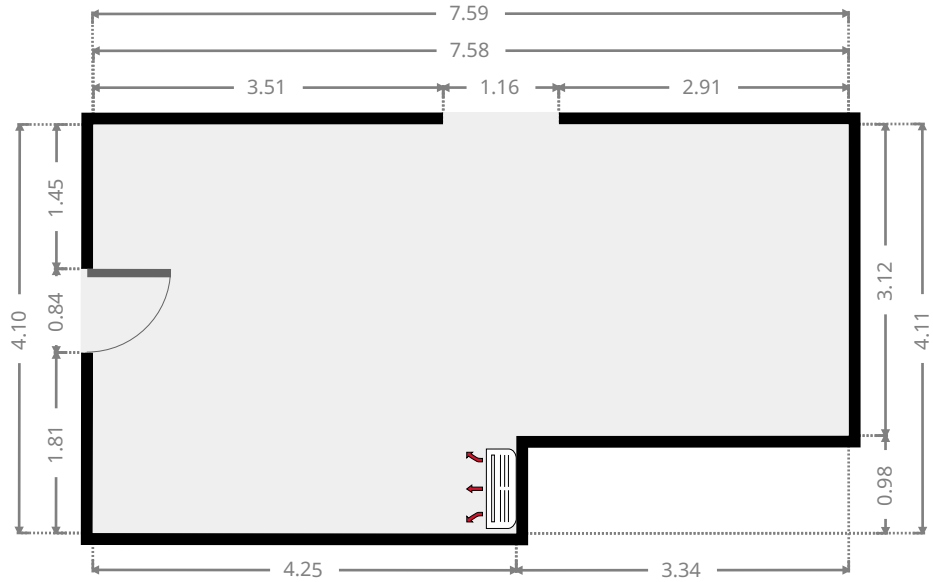
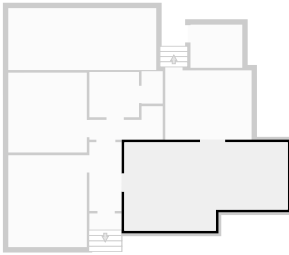

▼ **Other**  
Ground Floor

**WIDTH:** 1.50 m • **LENGTH:** 0.79 m  
**AREA:** 1.18 m<sup>2</sup> • **PERIMETER:** 4.57 m

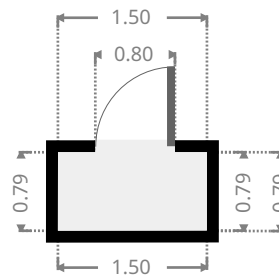
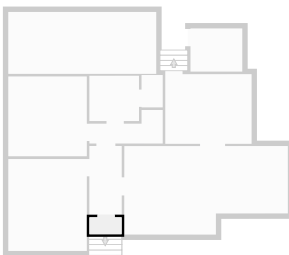

FLOORS: 1

▼ **Dining Room**  
Ground Floor

WIDTH: 4.00 m • LENGTH: 3.23 m  
AREA: 12.91 m<sup>2</sup> • PERIMETER: 14.46 m

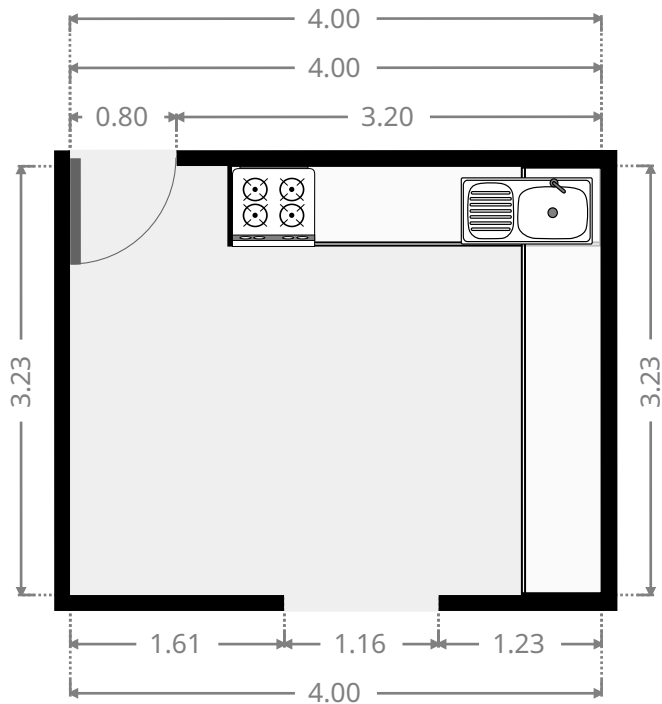
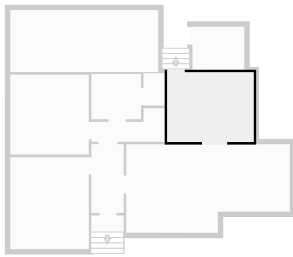

▼ **Laundry Room**  
Ground Floor

WIDTH: 2.40 m • LENGTH: 2.00 m  
AREA: 4.80 m<sup>2</sup> • PERIMETER: 8.80 m

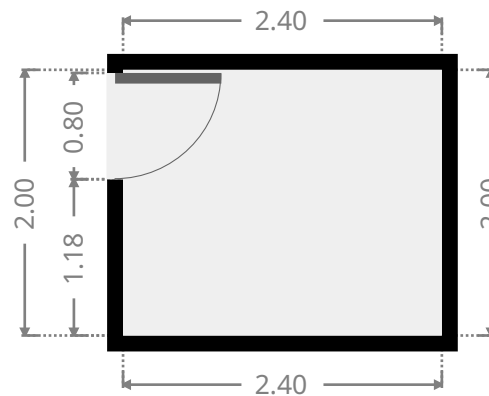

▼ **Other**  
Ground Floor

**WIDTH:** 6.86 m • **LENGTH:** 2.87 m  
**AREA:** 19.69 m<sup>2</sup> • **PERIMETER:** 19.46 m

