

# 45 Murphy Drive

## Ground Floor

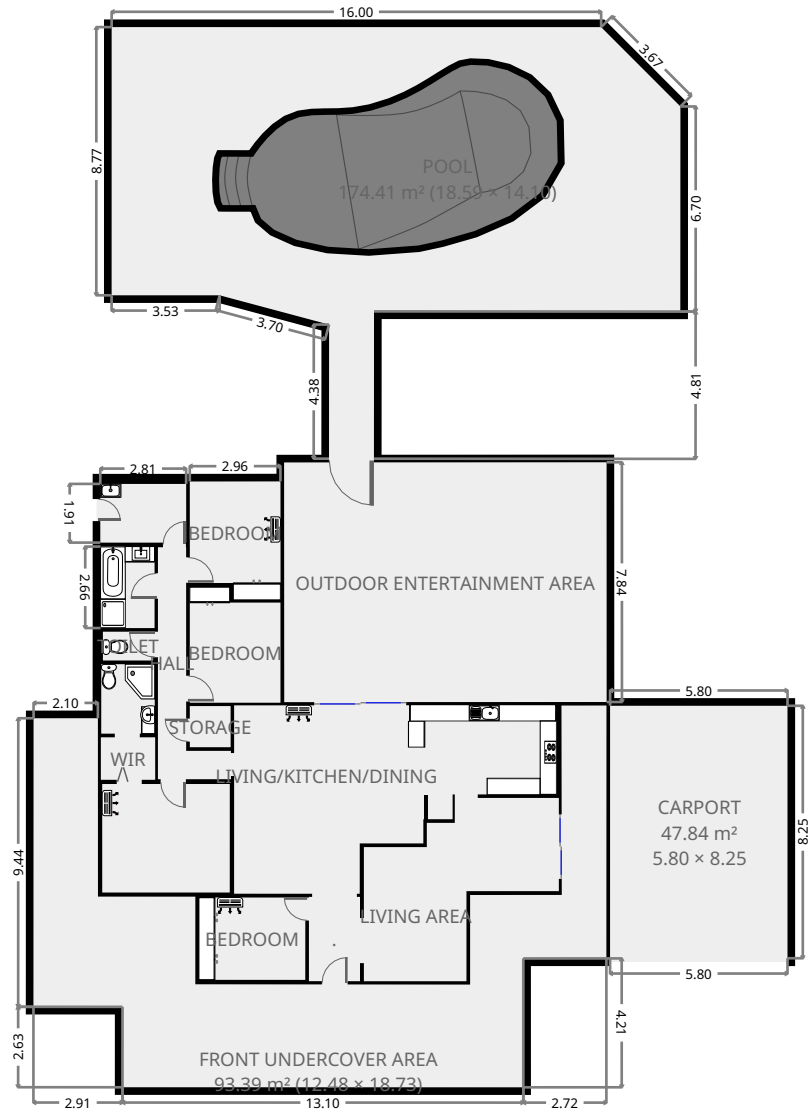

THIS FLOORPLAN IS PROVIDED WITHOUT WARRANTY OF ANY KIND. SENSOPIA DISCLAIMS ANY WARRANTY INCLUDING, WITHOUT LIMITATION, SATISFACTORY QUALITY OR ACCURACY OF DIMENSIONS.

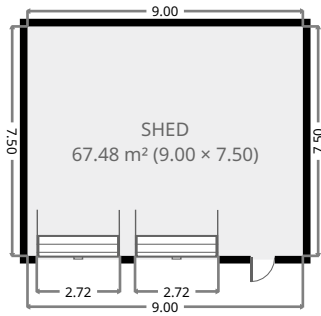

# 45 Murphy Drive

## Ensuite

Width: 1.75 m  
Length: 2.27 m  
Area: 3.97 m<sup>2</sup>  
Perimeter: 8.03 m

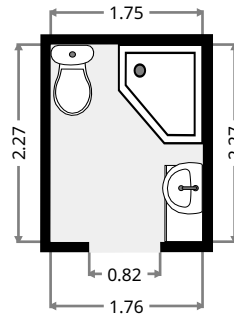
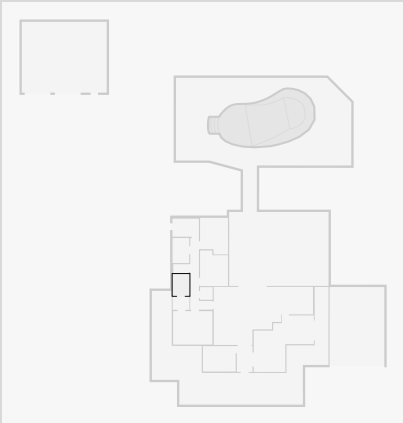

## Shed

Width: 7.50 m  
Length: 9.00 m  
Area: 67.48 m<sup>2</sup>  
Perimeter: 33.00 m

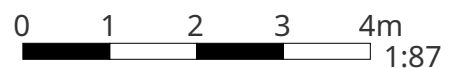
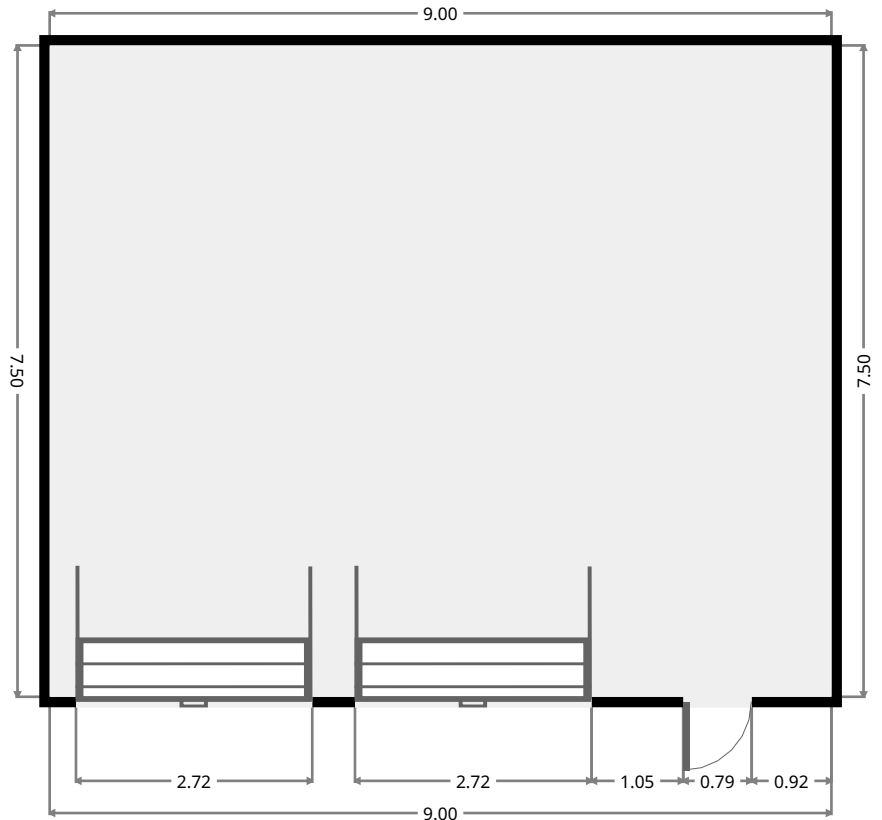
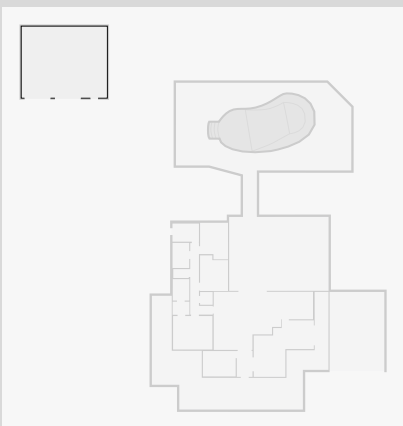

THIS FLOORPLAN IS PROVIDED WITHOUT WARRANTY OF ANY KIND. SENSOPIA DISCLAIMS ANY WARRANTY INCLUDING, WITHOUT LIMITATION, SATISFACTORY QUALITY OR ACCURACY OF DIMENSIONS.

# 45 Murphy Drive

## Pool

Width: 14.10 m  
Length: 18.59 m  
Area: 174.41 m<sup>2</sup>  
Perimeter: 63.04 m

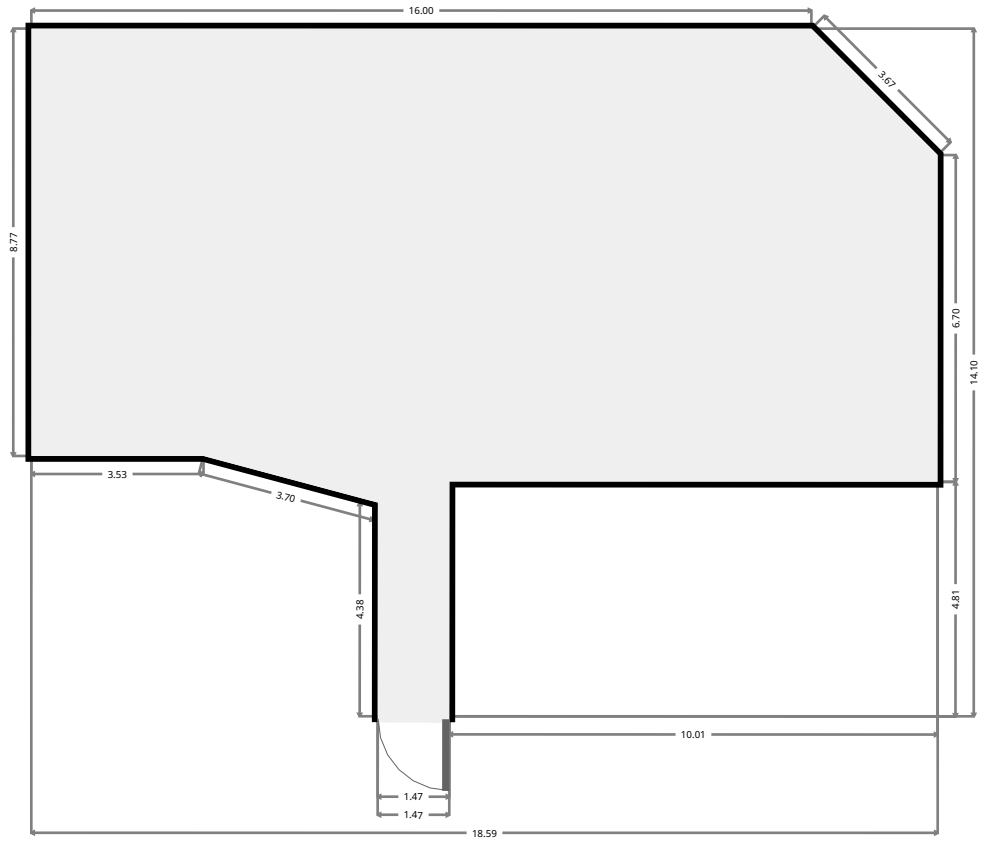
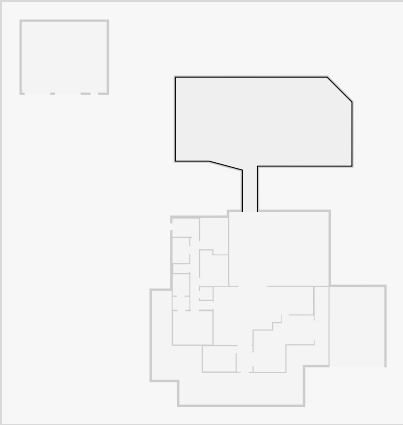

THIS FLOORPLAN IS PROVIDED WITHOUT WARRANTY OF ANY KIND. SENSOPIA DISCLAIMS ANY WARRANTY INCLUDING, WITHOUT LIMITATION, SATISFACTORY QUALITY OR ACCURACY OF DIMENSIONS.



# 45 Murphy Drive

## Carport

Width: 5.80 m  
 Length: 8.25 m  
 Area: 47.84 m<sup>2</sup>  
 Perimeter: 28.10 m

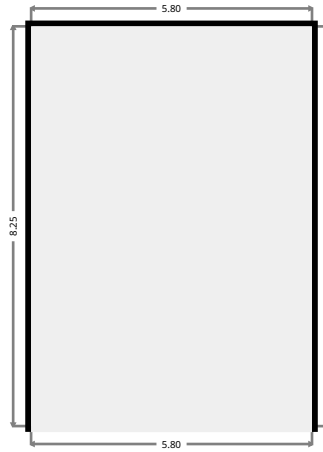
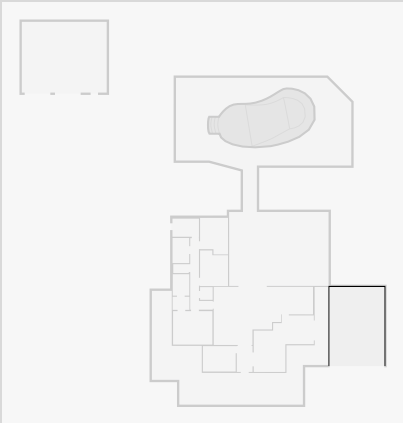

## Front UnderCover Area

Width: 12.48 m  
 Length: 18.73 m  
 Area: 93.39 m<sup>2</sup>  
 Perimeter: 79.81 m

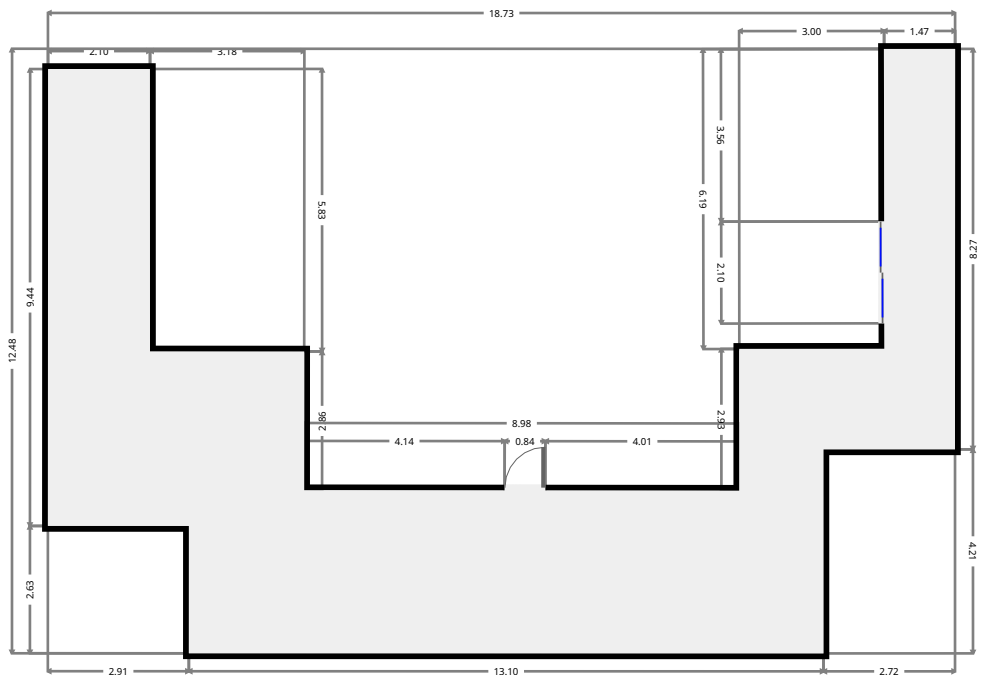
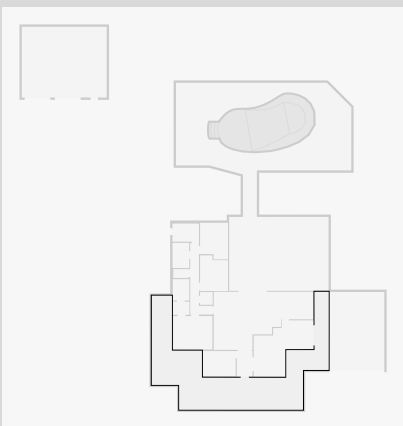

THIS FLOORPLAN IS PROVIDED WITHOUT WARRANTY OF ANY KIND. SENSOPIA DISCLAIMS ANY WARRANTY INCLUDING, WITHOUT LIMITATION, SATISFACTORY QUALITY OR ACCURACY OF DIMENSIONS.

# 45 Murphy Drive

## Outdoor Entertainment Area

Width: 7.83 m  
Length: 10.54 m  
Area: 82.57 m<sup>2</sup>  
Perimeter: 36.75 m

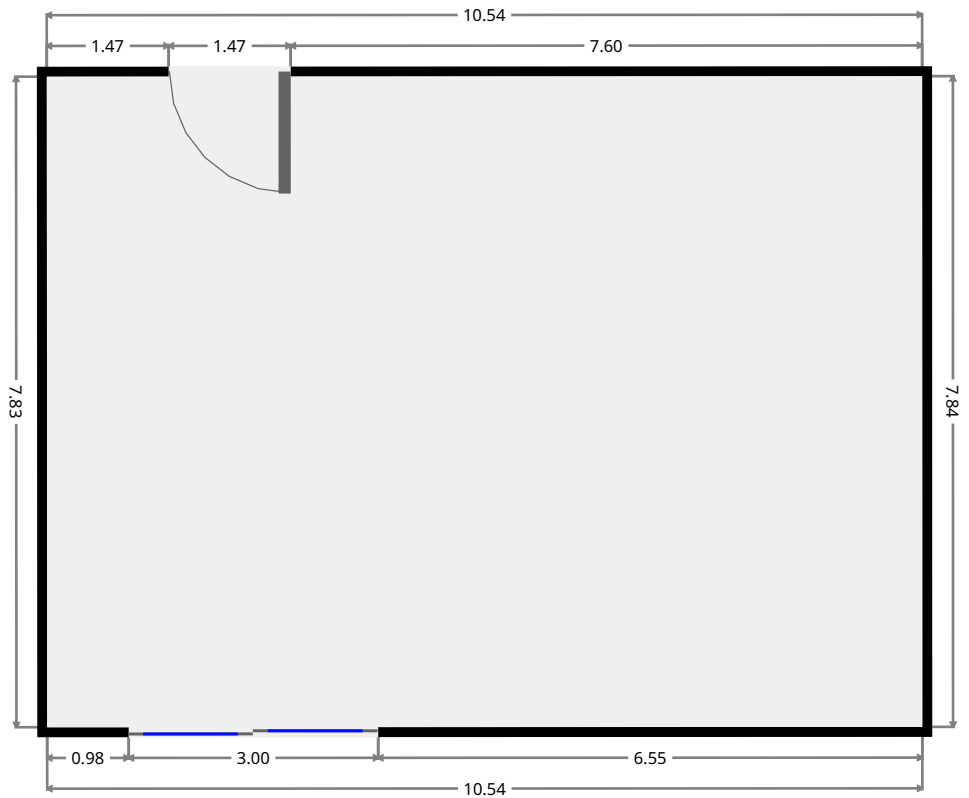
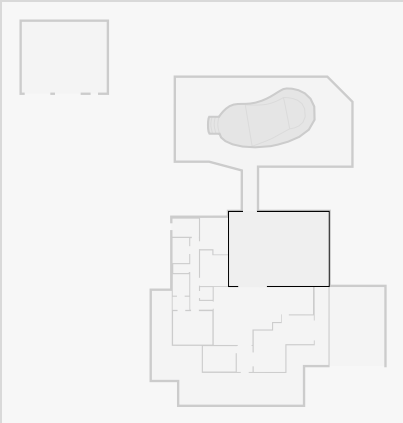

# 45 Murphy Drive

## Bedroom

Width: 2.96 m  
 Length: 3.88 m  
 Area: 10.69 m<sup>2</sup>  
 Perimeter: 13.67 m

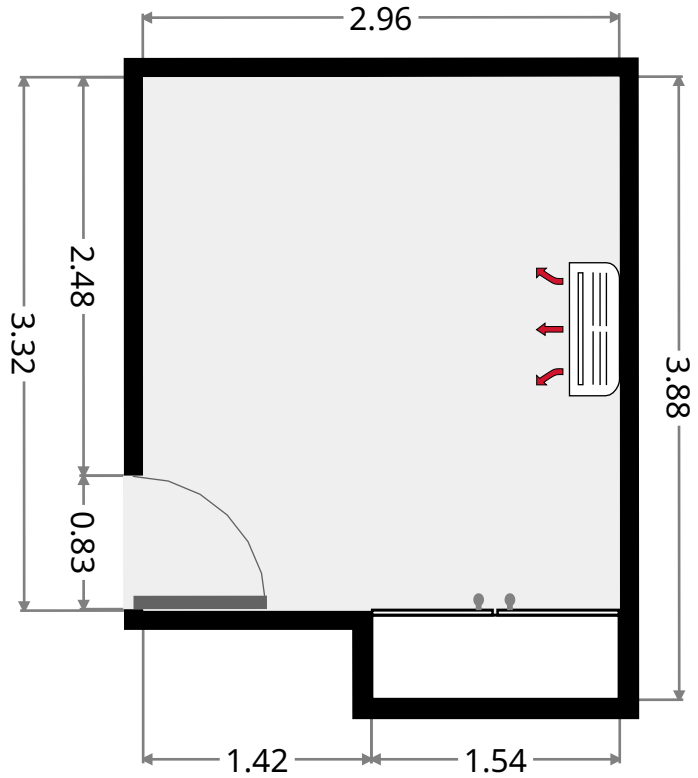
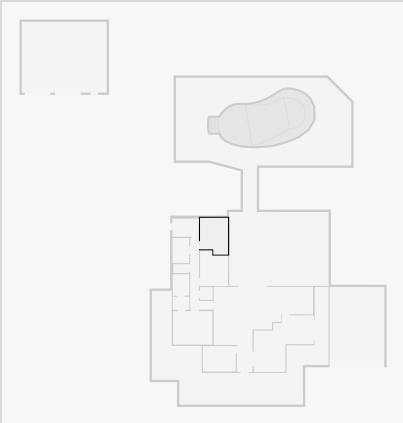

## Laundry Room

Width: 1.91 m  
 Length: 2.81 m  
 Area: 5.38 m<sup>2</sup>  
 Perimeter: 9.45 m

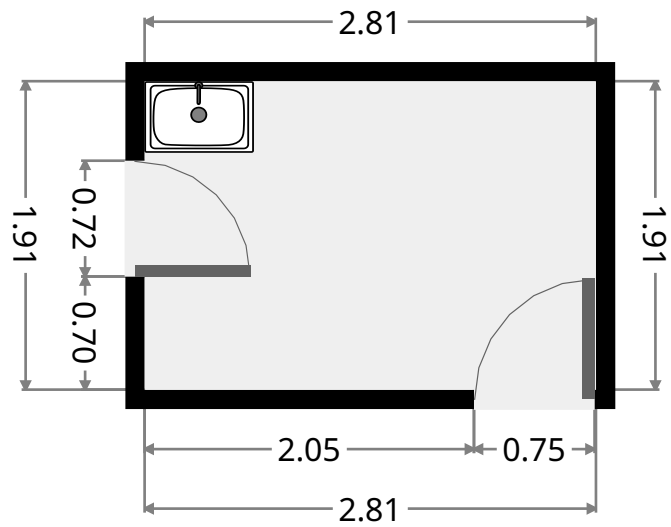
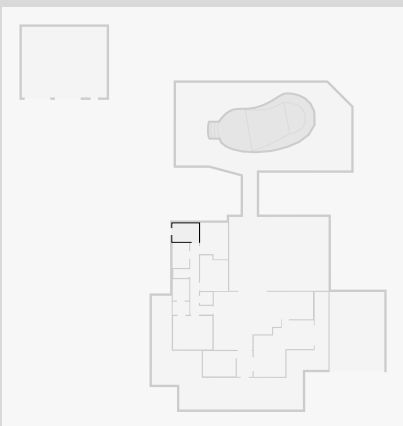

# 45 Murphy Drive

## Bathroom

Width: 1.76 m  
Length: 2.67 m  
Area: 4.70 m<sup>2</sup>  
Perimeter: 8.86 m

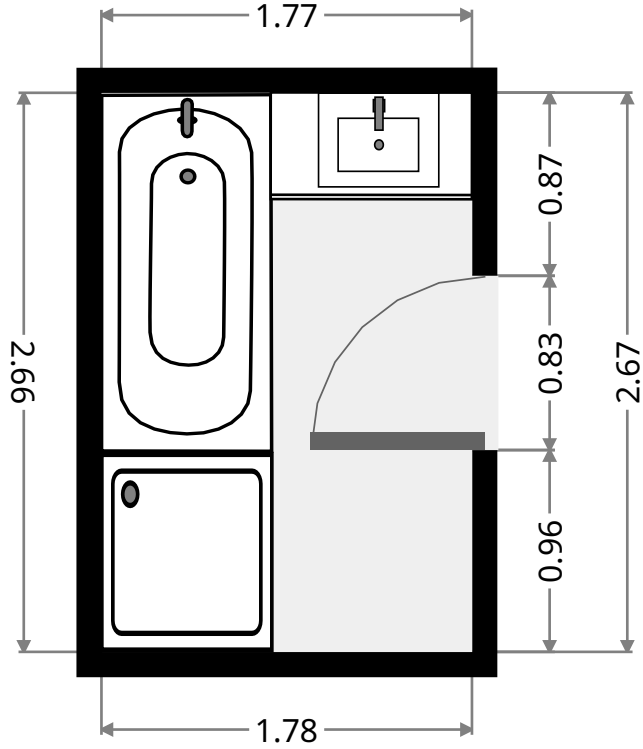
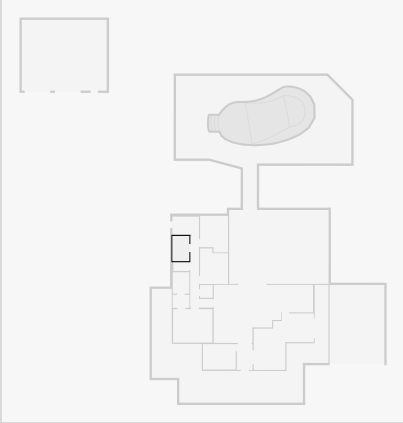

## Toilet

Width: 0.94 m  
Length: 1.64 m  
Area: 1.54 m<sup>2</sup>  
Perimeter: 5.16 m

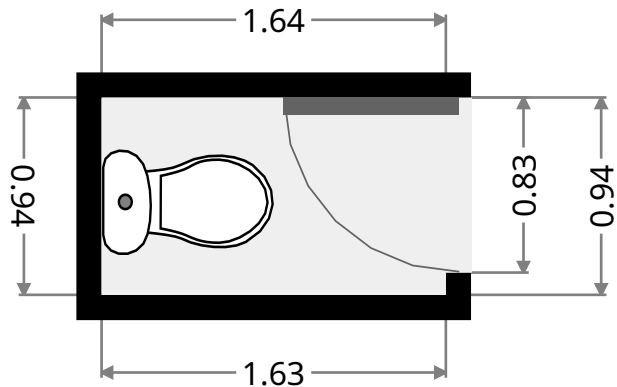
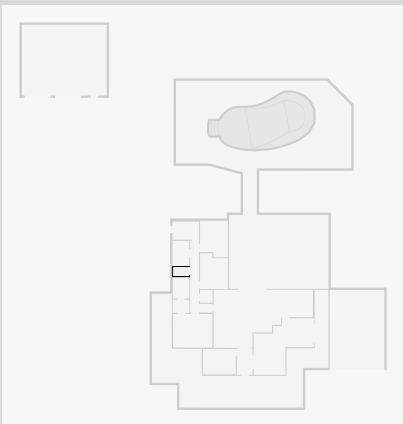

# 45 Murphy Drive

•  
 Width: 1.67 m  
 Length: 2.77 m  
 Area: 4.60 m<sup>2</sup>  
 Perimeter: 8.85 m

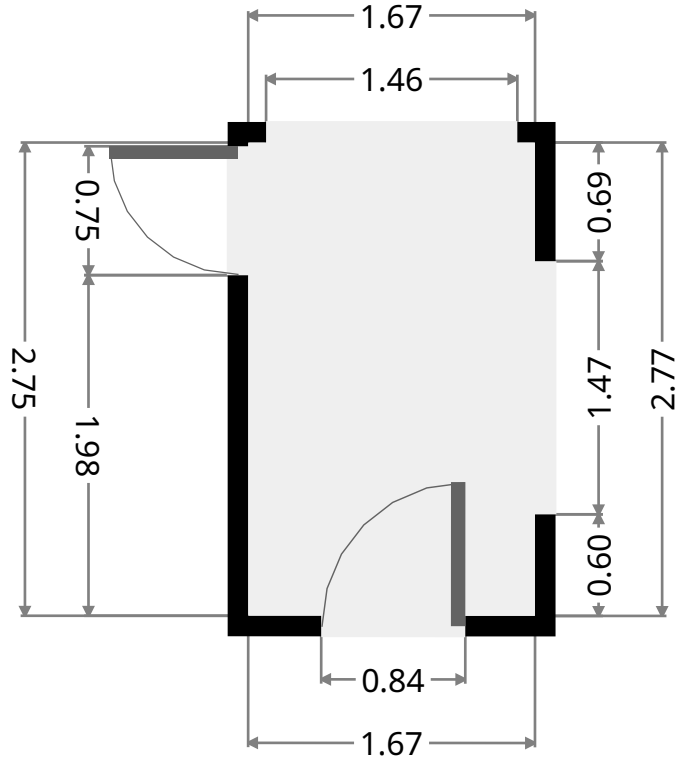
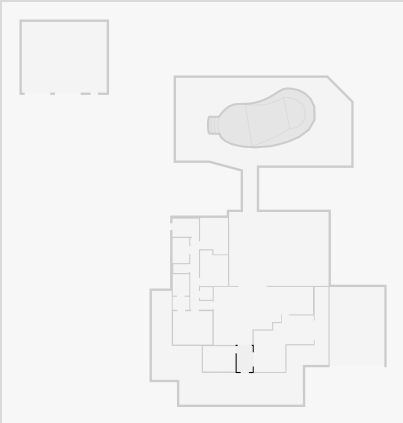

## WIR

Width: 1.39 m  
 Length: 1.77 m  
 Area: 2.46 m<sup>2</sup>  
 Perimeter: 6.33 m

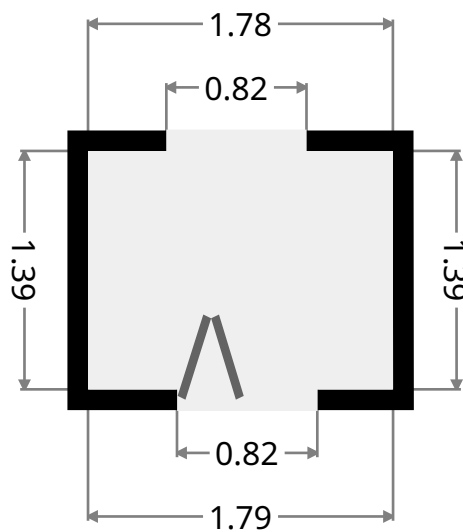
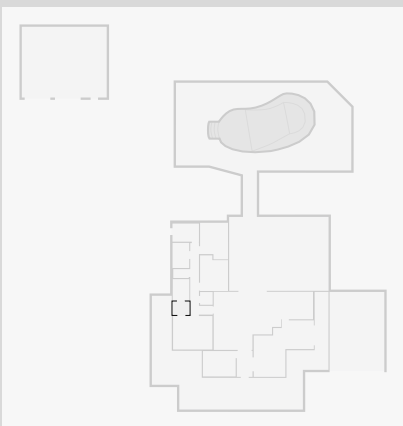



# 45 Murphy Drive

## Master Bedroom

Width: 3.54 m  
 Length: 4.17 m  
 Area: 14.78 m<sup>2</sup>  
 Perimeter: 15.43 m

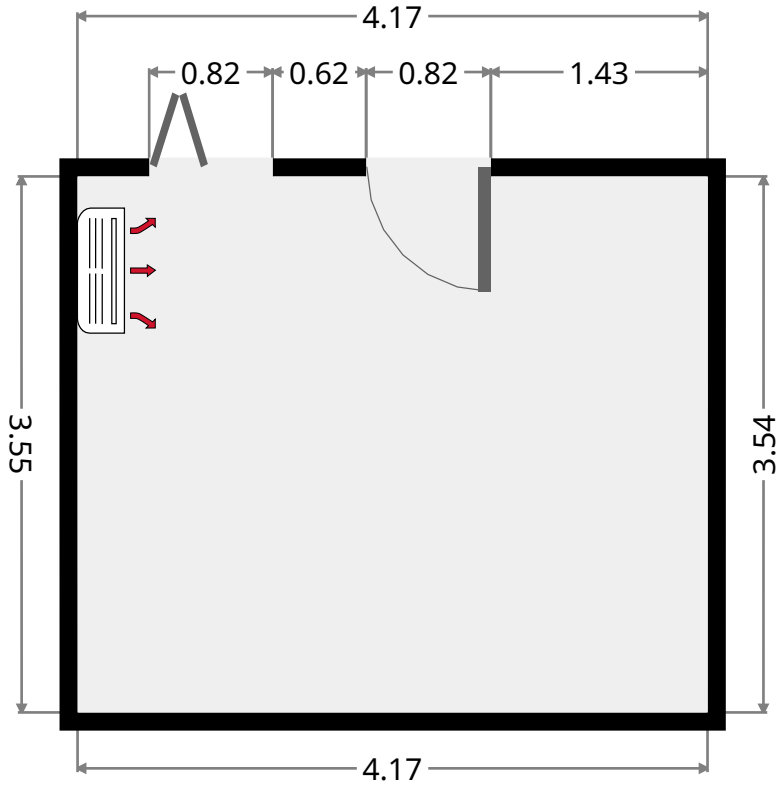
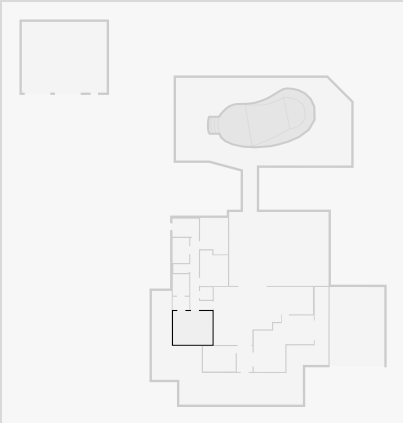

## Storage

Width: 1.33 m  
 Length: 1.34 m  
 Area: 1.79 m<sup>2</sup>  
 Perimeter: 5.35 m

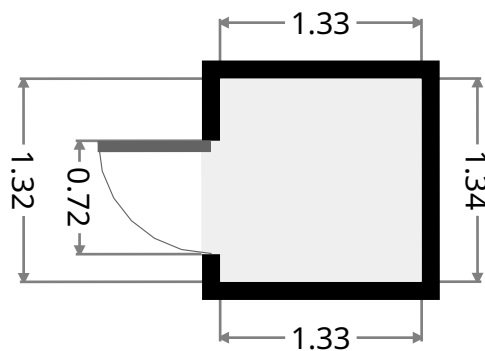
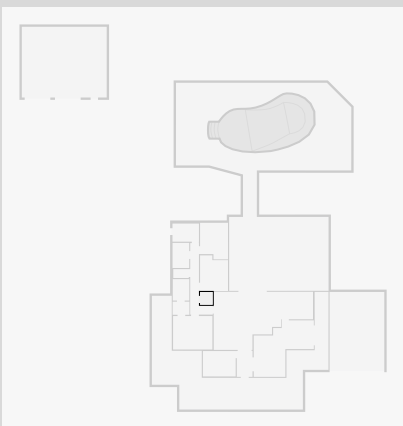

# 45 Murphy Drive

## Bedroom

Width: 2.96 m  
 Length: 3.78 m  
 Area: 10.35 m<sup>2</sup>  
 Perimeter: 13.48 m

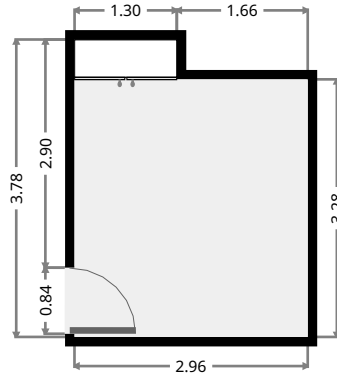
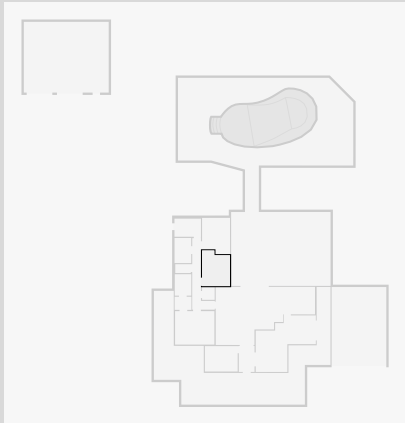

## Hall

Width: 2.40 m  
 Length: 7.57 m  
 Area: 8.34 m<sup>2</sup>  
 Perimeter: 19.93 m

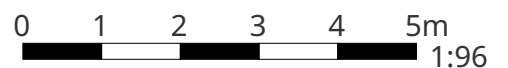
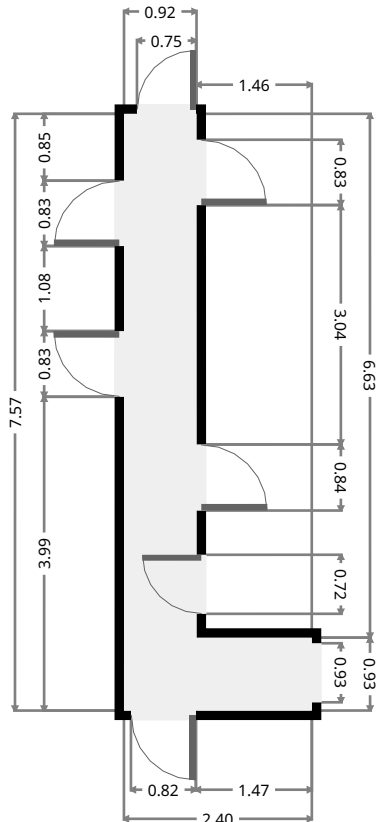
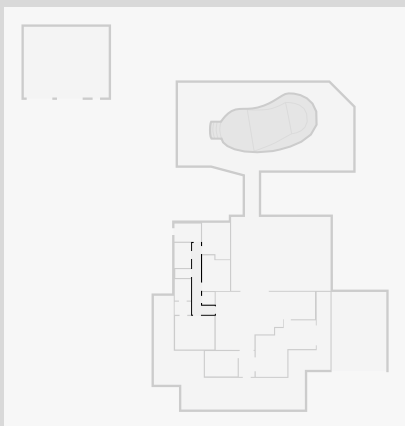

THIS FLOORPLAN IS PROVIDED WITHOUT WARRANTY OF ANY KIND. SENSOPIA DISCLAIMS ANY WARRANTY INCLUDING, WITHOUT LIMITATION, SATISFACTORY QUALITY OR ACCURACY OF DIMENSIONS.

# 45 Murphy Drive

## Living Area

Width: 5.99 m  
 Length: 6.37 m  
 Area: 25.23 m<sup>2</sup>  
 Perimeter: 24.73 m

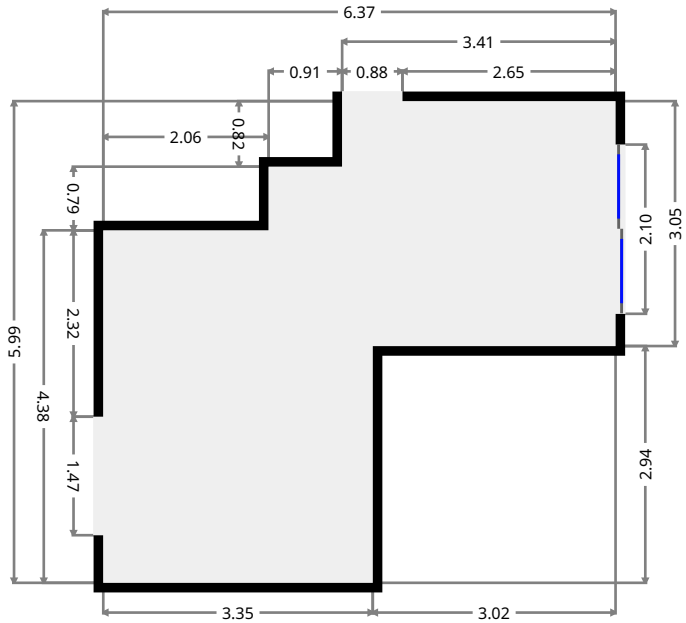
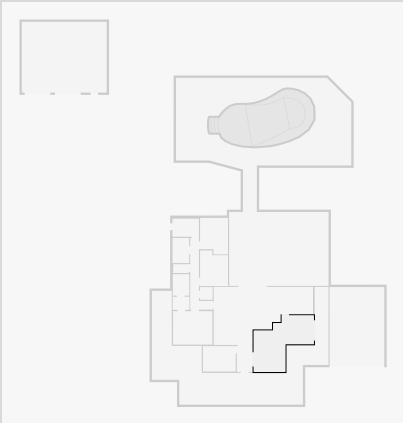

## Living/Kitchen/Dining

Width: 6.15 m  
 Length: 10.53 m  
 Area: 48.09 m<sup>2</sup>  
 Perimeter: 33.37 m

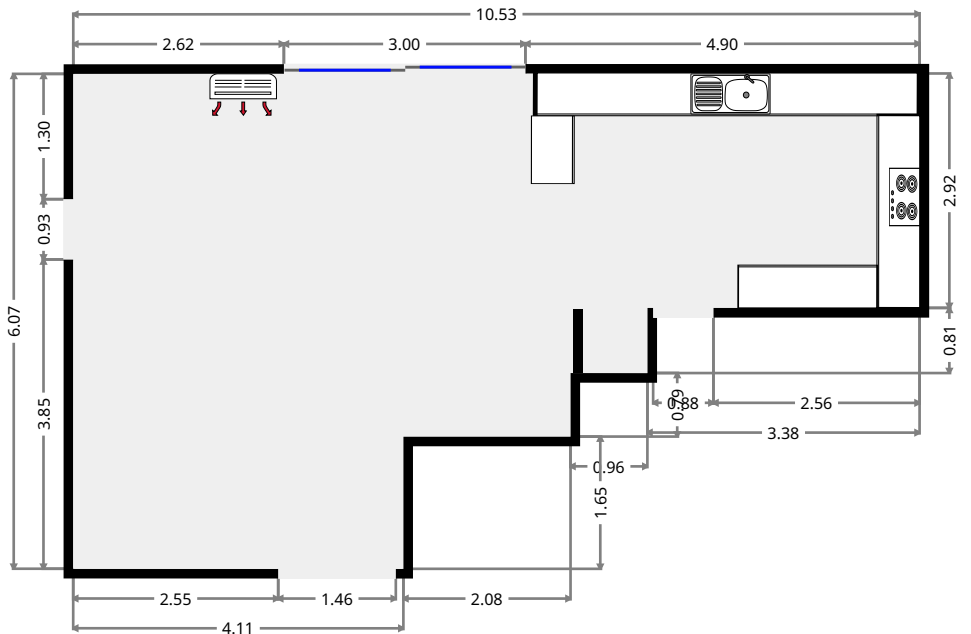
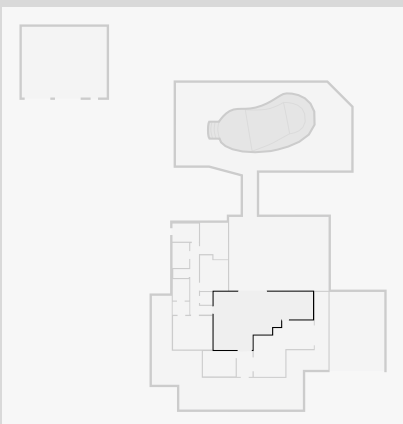

THIS FLOORPLAN IS PROVIDED WITHOUT WARRANTY OF ANY KIND. SENSOPIA DISCLAIMS ANY WARRANTY INCLUDING, WITHOUT LIMITATION, SATISFACTORY QUALITY OR ACCURACY OF DIMENSIONS.

# 45 Murphy Drive

## Bedroom

Width: 2.68 m  
Length: 3.48 m  
Area: 9.35 m<sup>2</sup>  
Perimeter: 12.33 m

