

45 MCKELLIGETT STREET

Created on
2021-03-18

Floors
1

▼ Ground Floor

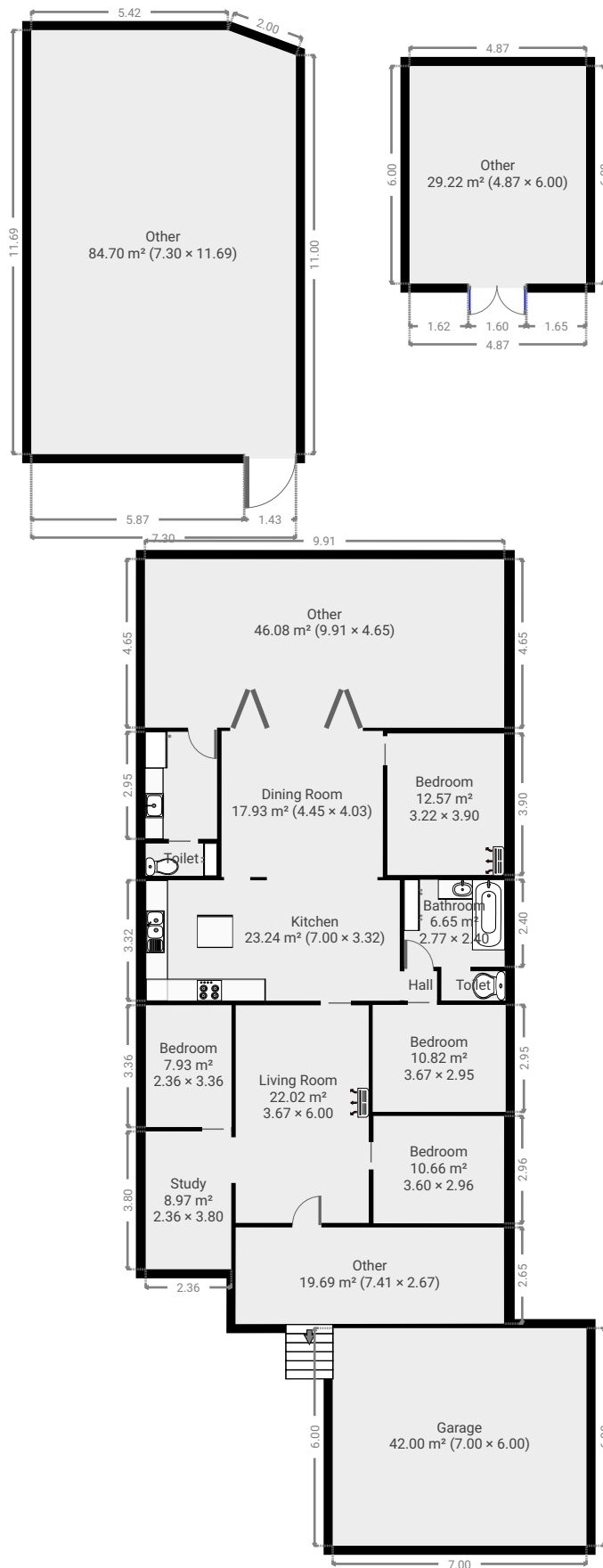

▼ **Bathroom**
Ground Floor

WIDTH: 2.77 m • LENGTH: 2.40 m
AREA: 6.65 m² • PERIMETER: 10.34 m

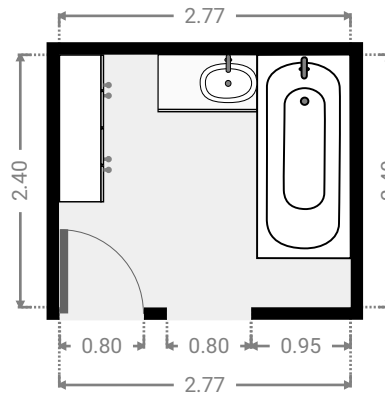

▼ **Garage**
Ground Floor

WIDTH: 7.00 m • LENGTH: 6.00 m
AREA: 42.00 m² • PERIMETER: 26.00 m

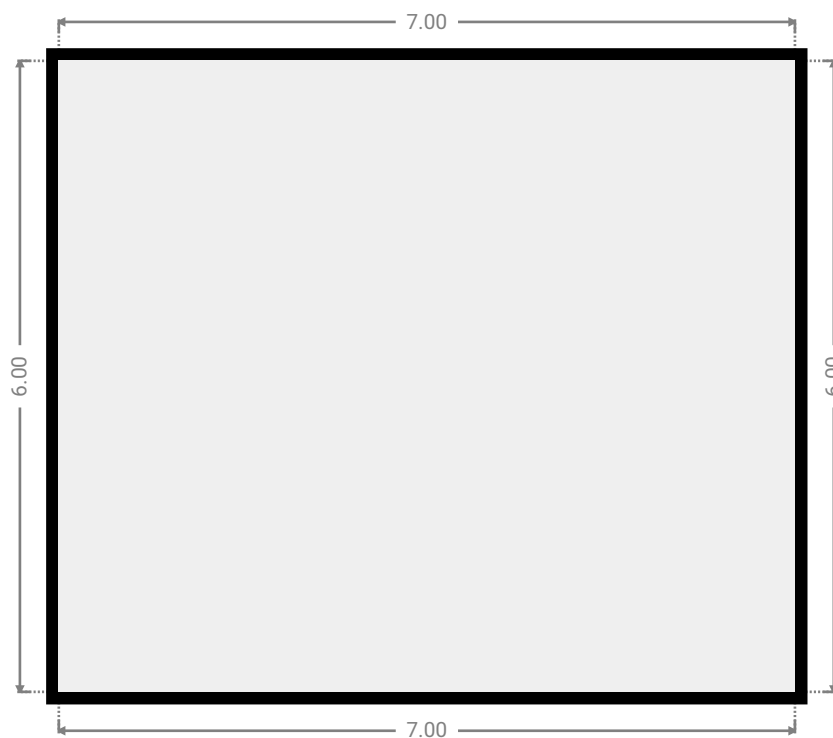
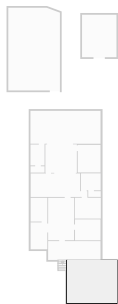

▼ **Other**
Ground Floor

WIDTH: 4.87 m • LENGTH: 6.00 m
AREA: 29.22 m² • PERIMETER: 21.74 m

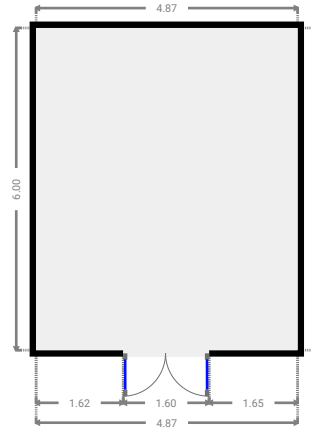
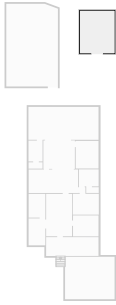

▼ **Other**
Ground Floor

WIDTH: 7.30 m • LENGTH: 11.69 m
AREA: 84.70 m² • PERIMETER: 37.42 m

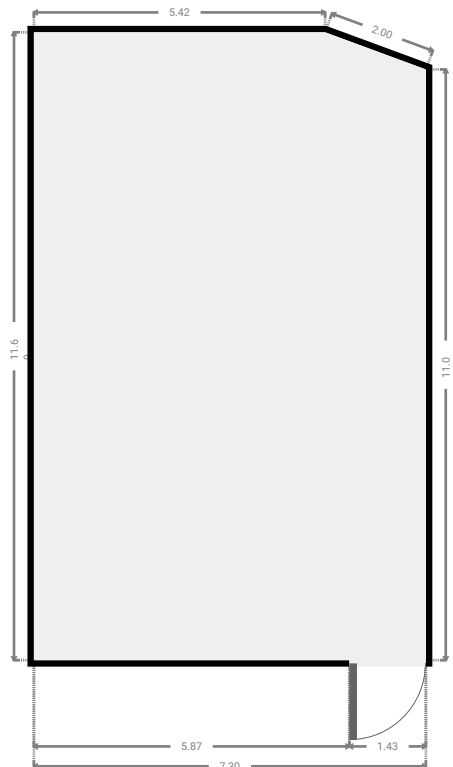
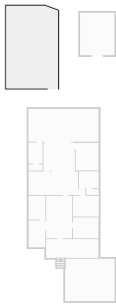

▼ Other
Ground Floor

WIDTH: 9.91 m • LENGTH: 4.65 m
AREA: 46.08 m² • PERIMETER: 29.12 m

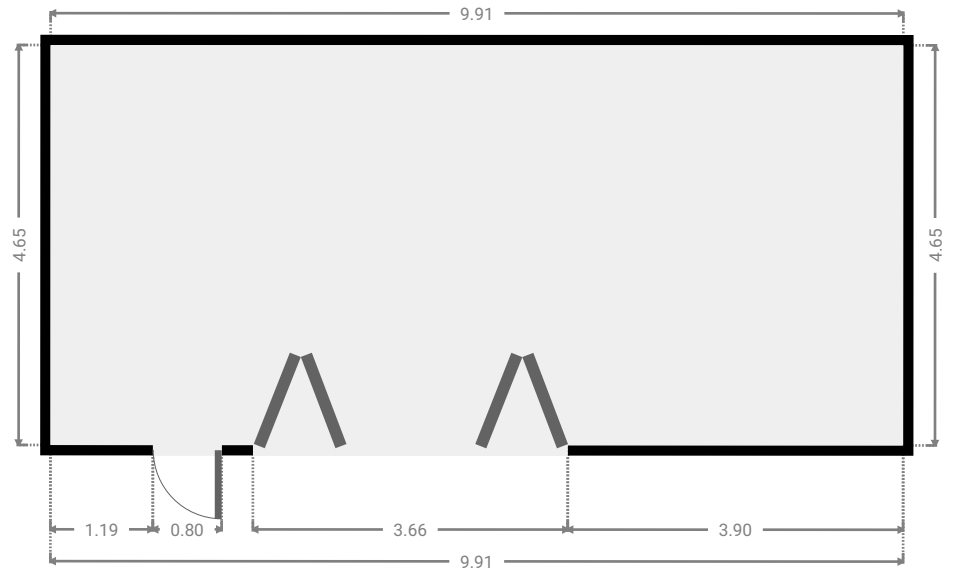
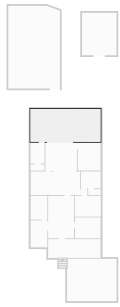

▼ Other
Ground Floor

WIDTH: 7.41 m • LENGTH: 2.67 m
AREA: 19.69 m² • PERIMETER: 20.13 m

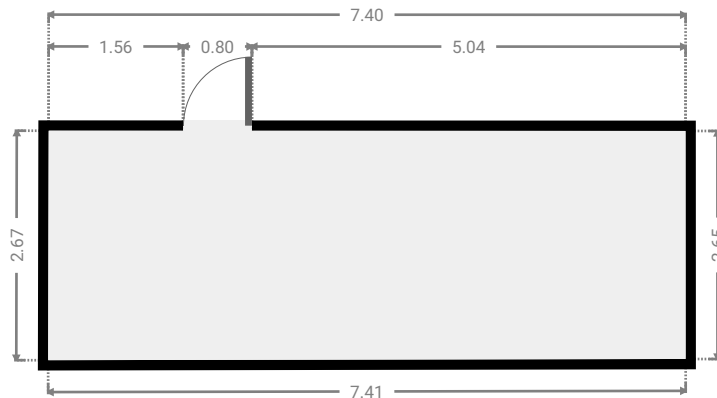
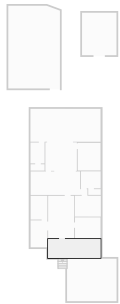

▼ **Bedroom**
Ground Floor

WIDTH: 3.22 m • LENGTH: 3.90 m
AREA: 12.57 m² • PERIMETER: 14.25 m

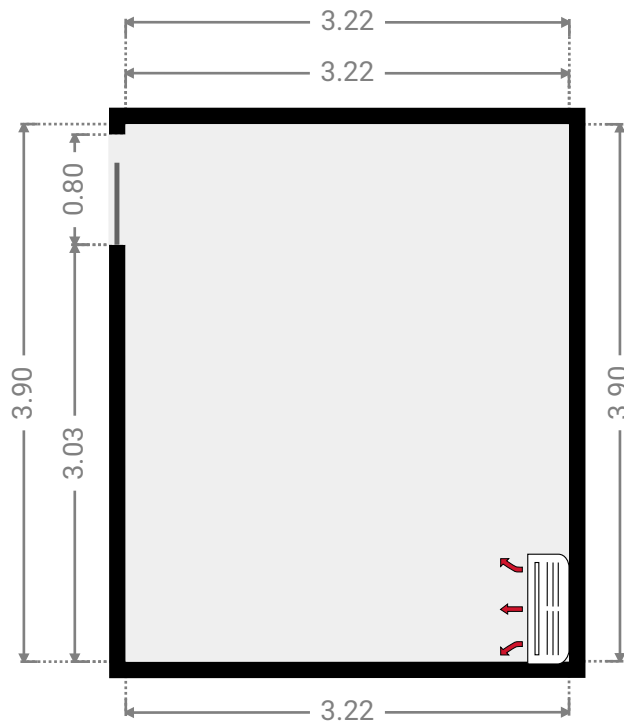
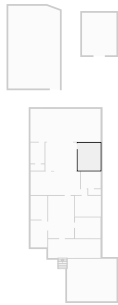

▼ **Laundry Room**
Ground Floor

WIDTH: 1.98 m • LENGTH: 2.95 m
AREA: 5.84 m² • PERIMETER: 9.86 m

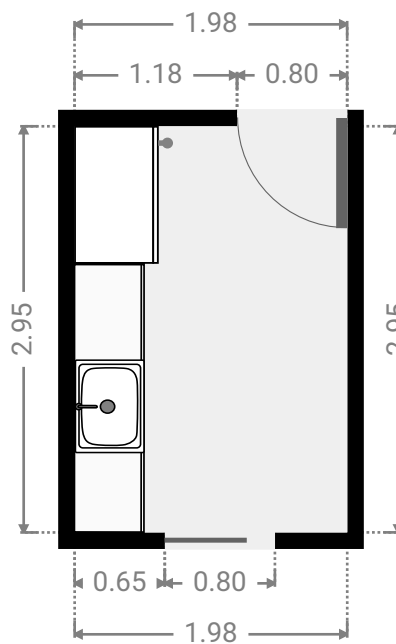
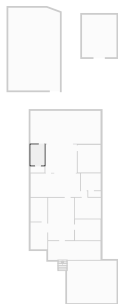

▼ **Toilet**
Ground Floor

WIDTH: 1.97 m • LENGTH: 0.89 m
AREA: 1.75 m² • PERIMETER: 5.72 m

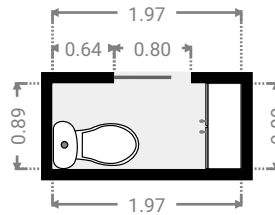
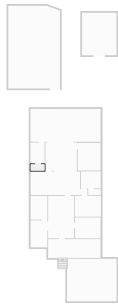

▼ **Living Room**
Ground Floor

WIDTH: 3.67 m • LENGTH: 6.00 m
AREA: 22.02 m² • PERIMETER: 19.34 m

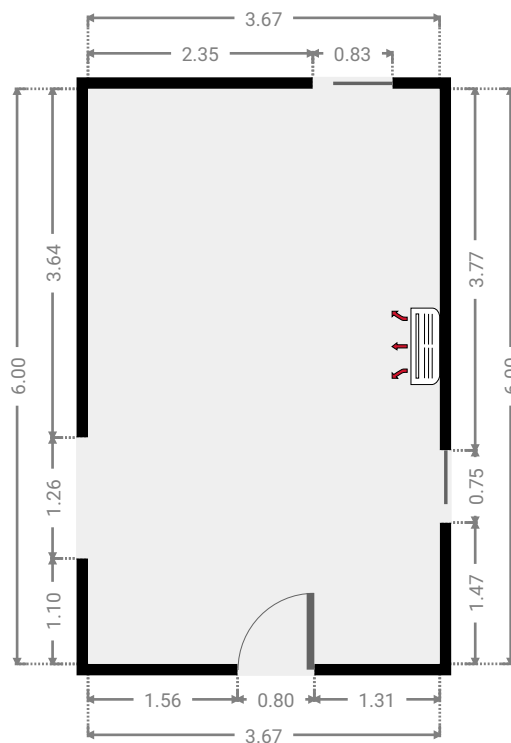
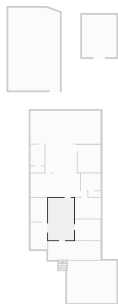

▼ Toilet
Ground Floor

WIDTH: 1.77 m • LENGTH: 0.81 m
AREA: 1.42 m² • PERIMETER: 5.14 m

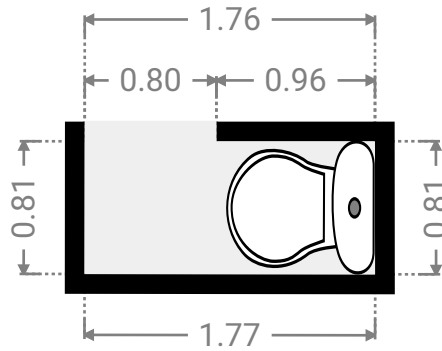
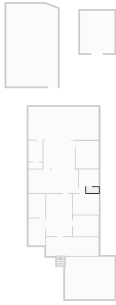

▼ Bedroom
Ground Floor

WIDTH: 3.67 m • LENGTH: 2.95 m
AREA: 10.82 m² • PERIMETER: 13.24 m

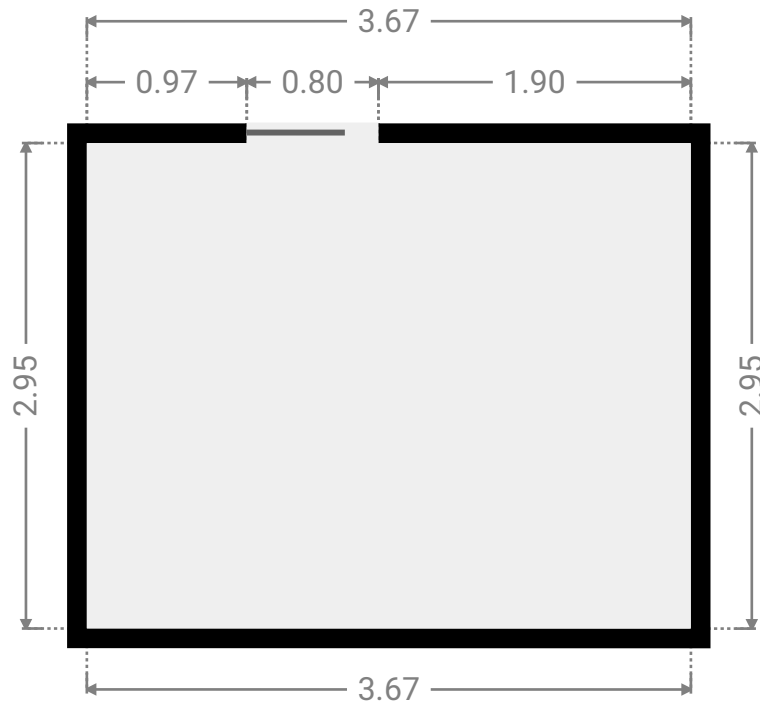
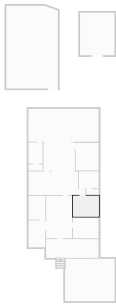

▼ **Hall**
Ground Floor

WIDTH: 0.90 m • LENGTH: 0.81 m
AREA: 0.73 m² • PERIMETER: 3.42 m

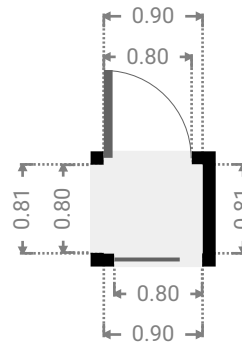
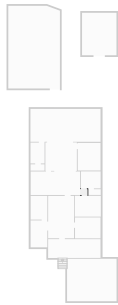

▼ **Dining Room**
Ground Floor

WIDTH: 4.45 m • LENGTH: 4.03 m
AREA: 17.93 m² • PERIMETER: 16.96 m

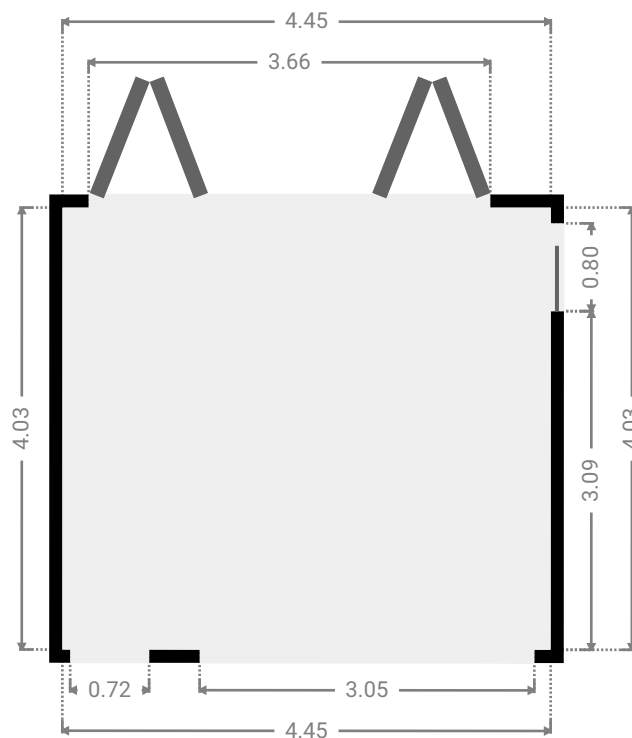
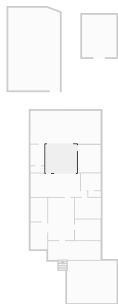

▼ **Kitchen**
Ground Floor

WIDTH: 7.00 m • LENGTH: 3.32 m
AREA: 23.24 m² • PERIMETER: 20.64 m

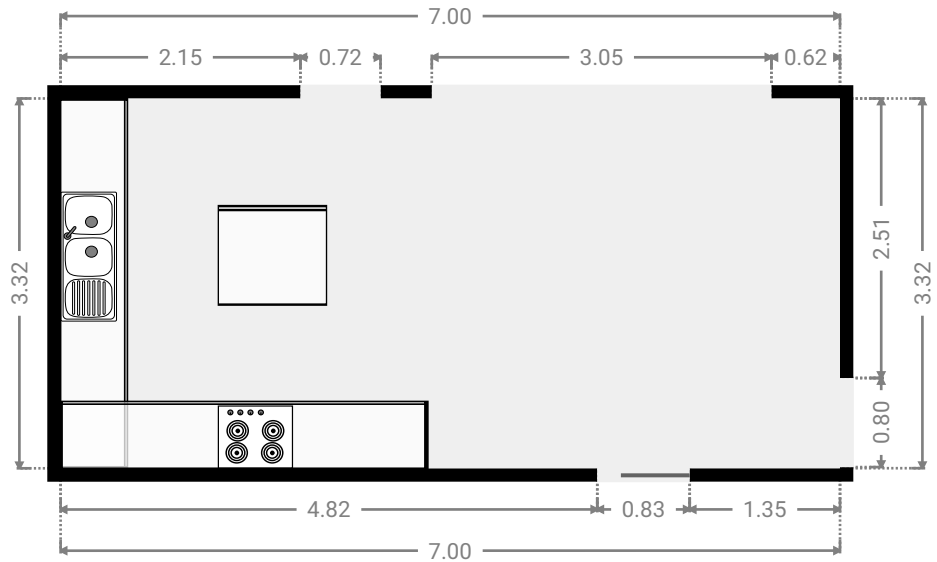
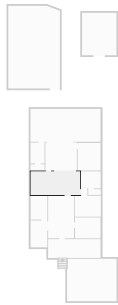

▼ **Bedroom**
Ground Floor

WIDTH: 3.60 m • LENGTH: 2.96 m
AREA: 10.66 m² • PERIMETER: 13.12 m

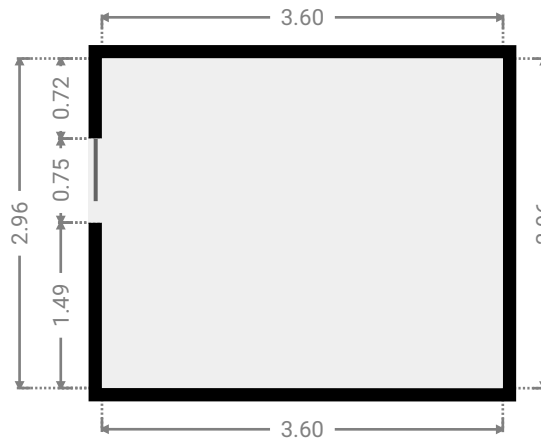
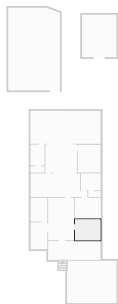

▼ **Bedroom**
Ground Floor

WIDTH: 2.36 m • LENGTH: 3.36 m
AREA: 7.93 m² • PERIMETER: 11.44 m

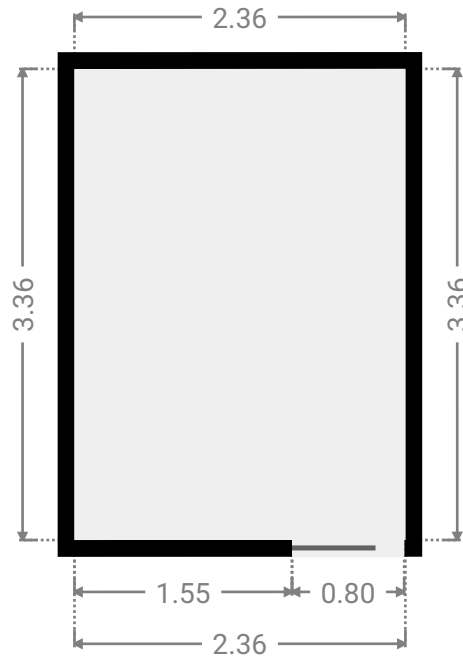
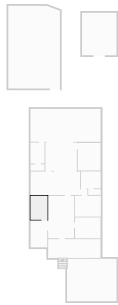

▼ **Study**
Ground Floor

WIDTH: 2.36 m • LENGTH: 3.80 m
AREA: 8.97 m² • PERIMETER: 12.32 m

