

44 Carara Drive

Created on
2021-02-09

Floors
1

▼ Ground Floor

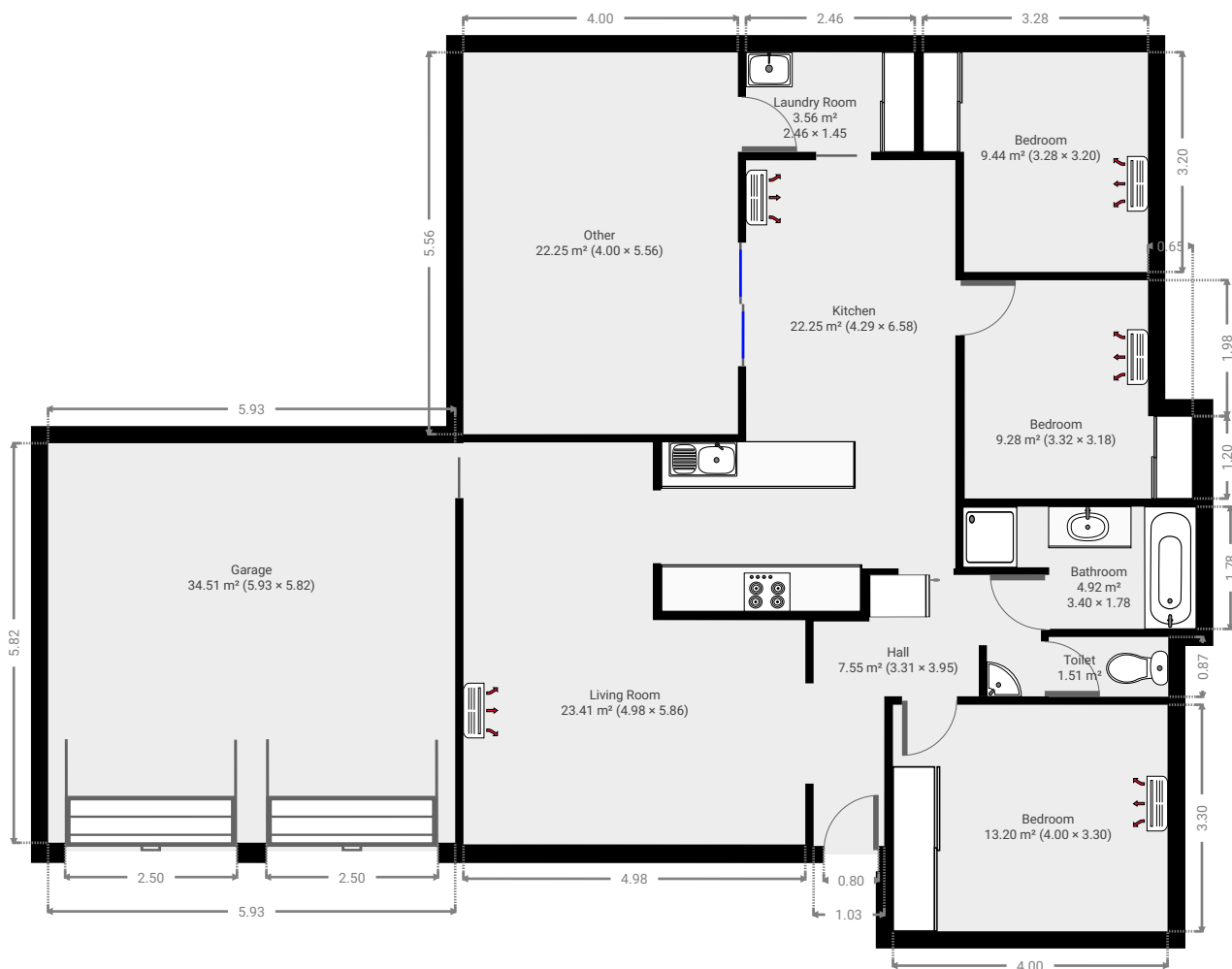
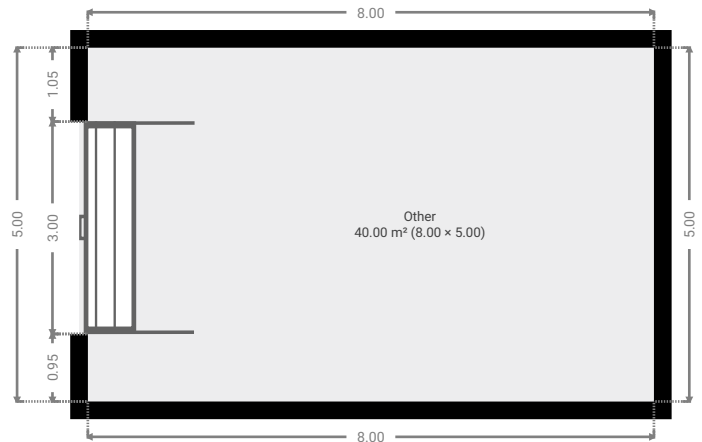

▼ **Hall**
Ground Floor

WIDTH: 3.31 m • LENGTH: 3.95 m
AREA: 7.55 m² • PERIMETER: 14.52 m

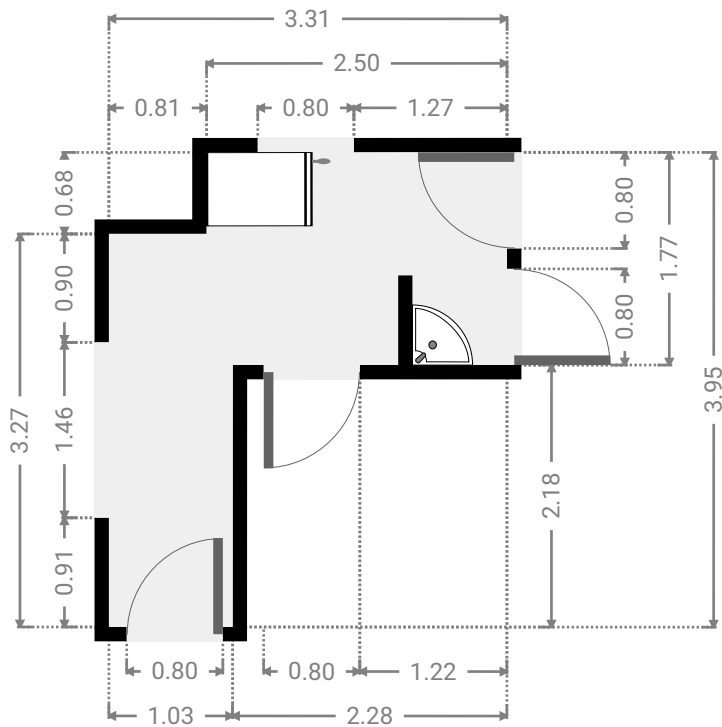
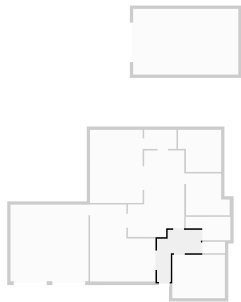

▼ **Bedroom**
Ground Floor

WIDTH: 4.00 m • LENGTH: 3.30 m
AREA: 13.20 m² • PERIMETER: 14.60 m

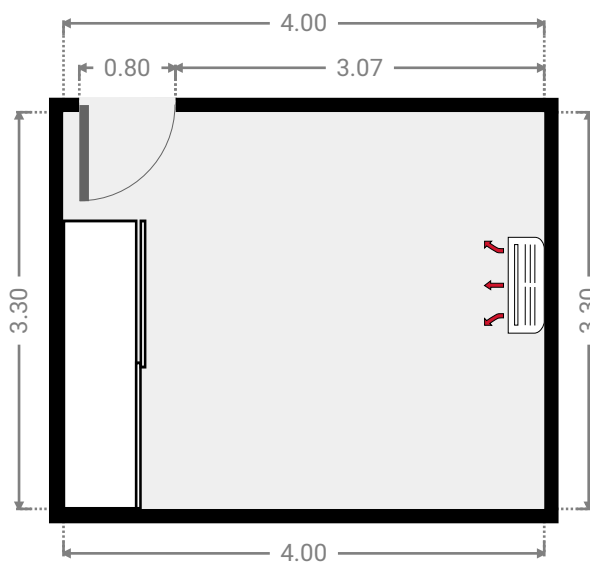
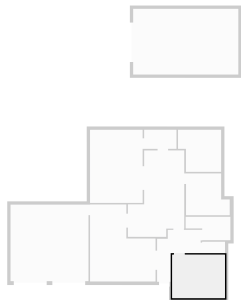

▼ Toilet
Ground Floor

WIDTH: 1.74 m • LENGTH: 0.87 m
AREA: 1.51 m² • PERIMETER: 5.22 m

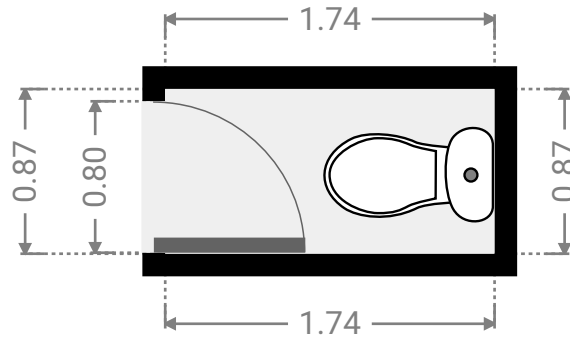

▼ Bathroom
Ground Floor

WIDTH: 3.40 m • LENGTH: 1.78 m
AREA: 4.92 m² • PERIMETER: 10.36 m

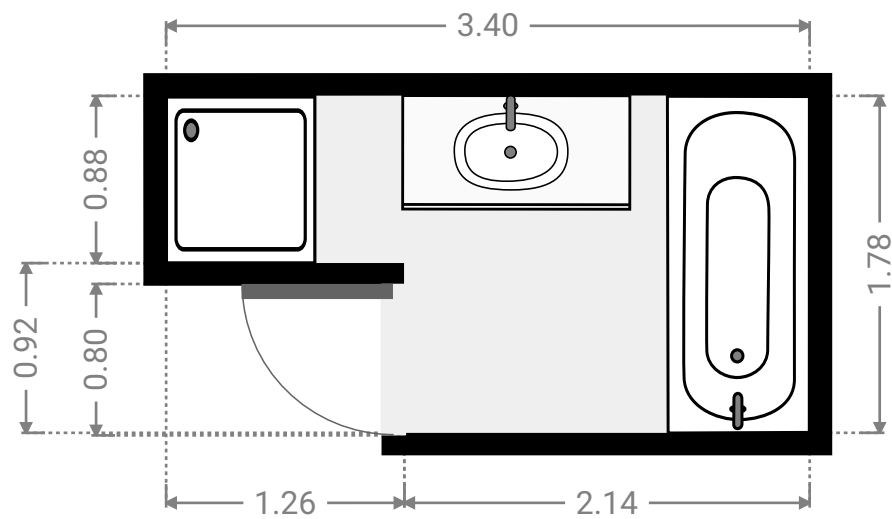
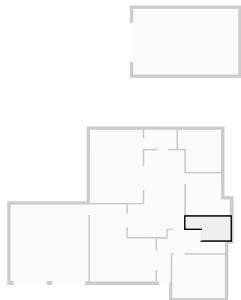

▼ **Kitchen**
Ground Floor

WIDTH: 4.29 m • LENGTH: 6.58 m
AREA: 22.25 m² • PERIMETER: 21.72 m

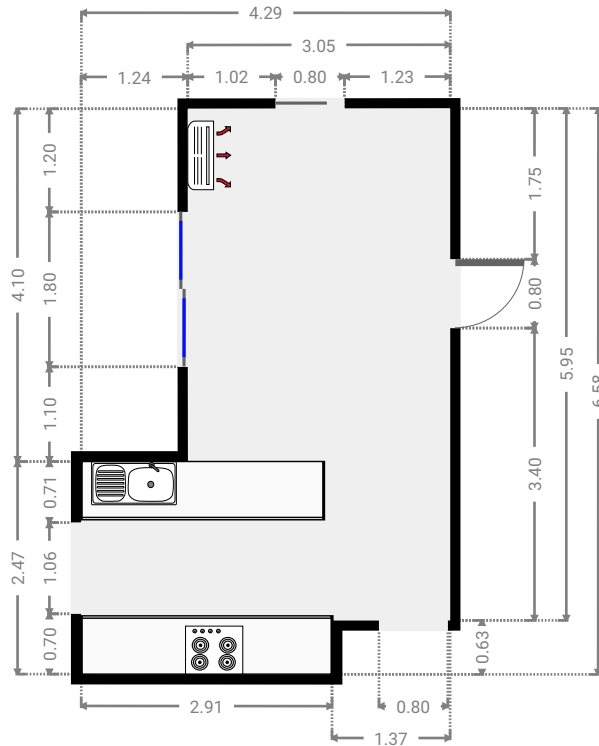
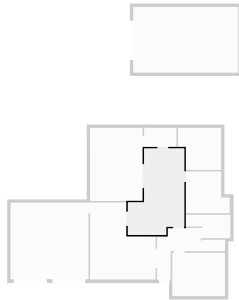

▼ **Bedroom**
Ground Floor

WIDTH: 3.32 m • LENGTH: 3.18 m
AREA: 9.28 m² • PERIMETER: 13.00 m

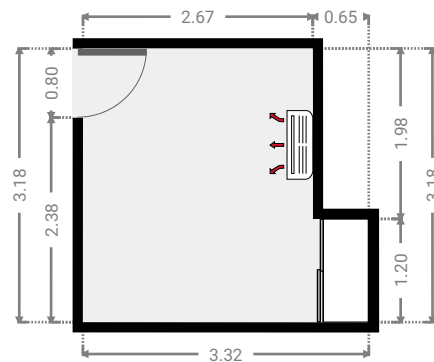
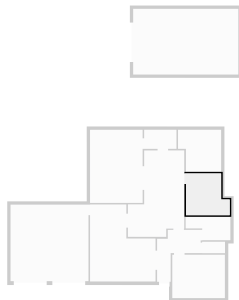

▼ **Bedroom**
Ground Floor

WIDTH: 3.28 m • LENGTH: 3.20 m
AREA: 9.44 m² • PERIMETER: 12.96 m

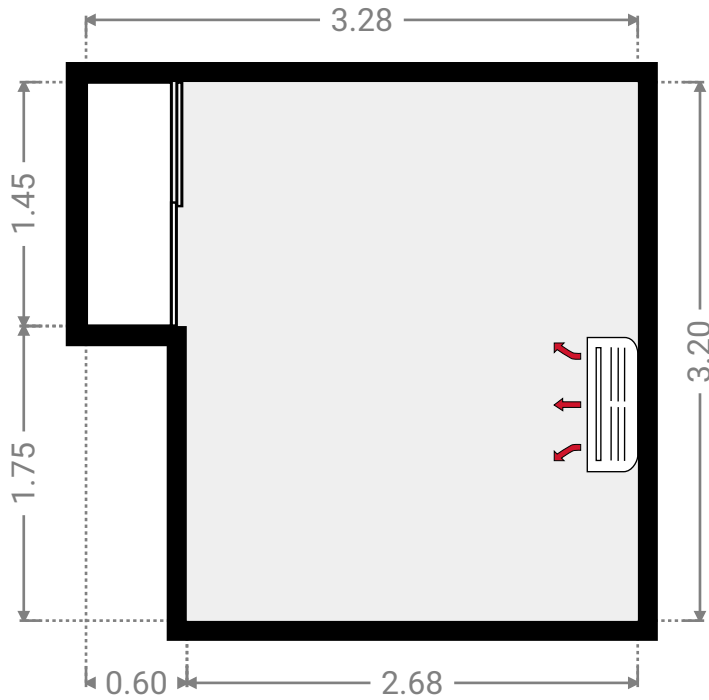
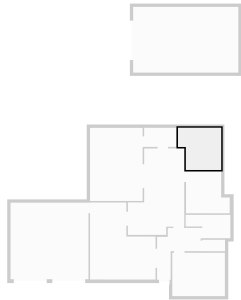

▼ **Laundry Room**
Ground Floor

WIDTH: 2.46 m • LENGTH: 1.45 m
AREA: 3.56 m² • PERIMETER: 7.81 m

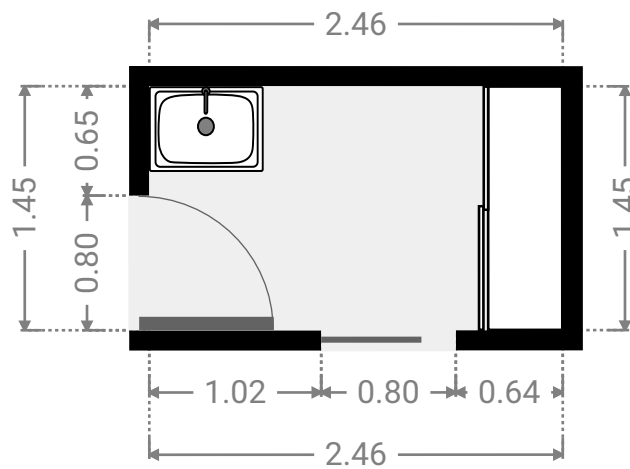
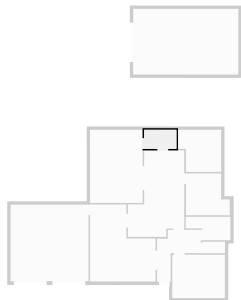

▼ Other
Ground Floor

WIDTH: 4.00 m • LENGTH: 5.56 m
AREA: 22.25 m² • PERIMETER: 19.12 m

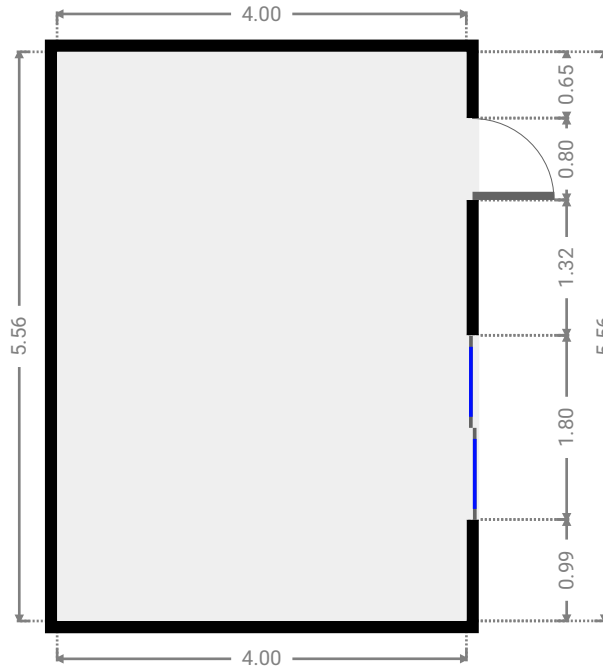
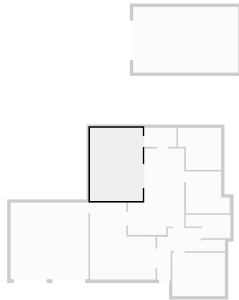

▼ Living Room
Ground Floor

WIDTH: 4.98 m • LENGTH: 5.86 m
AREA: 23.41 m² • PERIMETER: 21.67 m

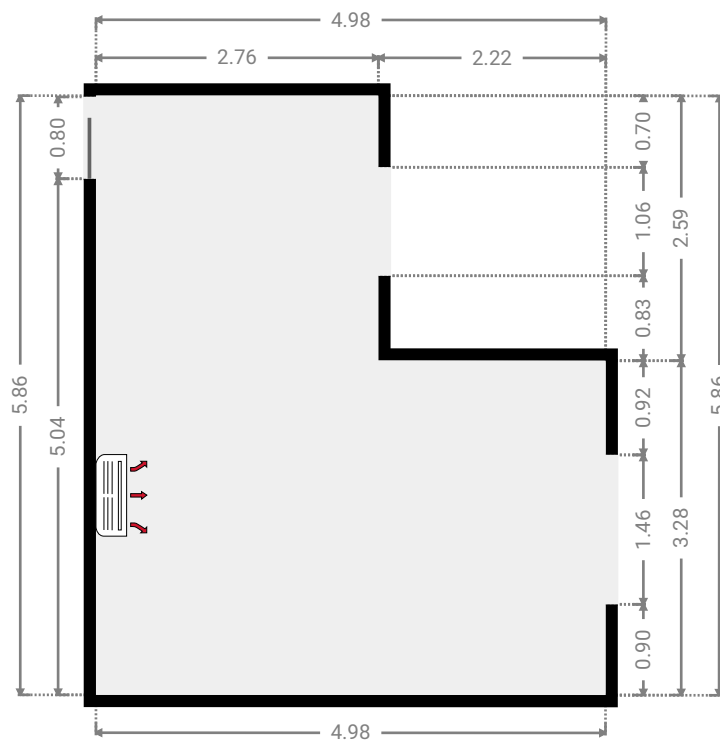
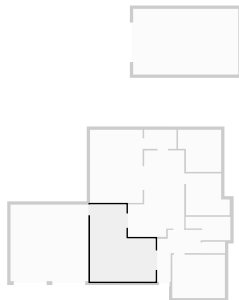

▼ **Garage**
Ground Floor

WIDTH: 5.93 m • LENGTH: 5.82 m
AREA: 34.51 m² • PERIMETER: 23.50 m

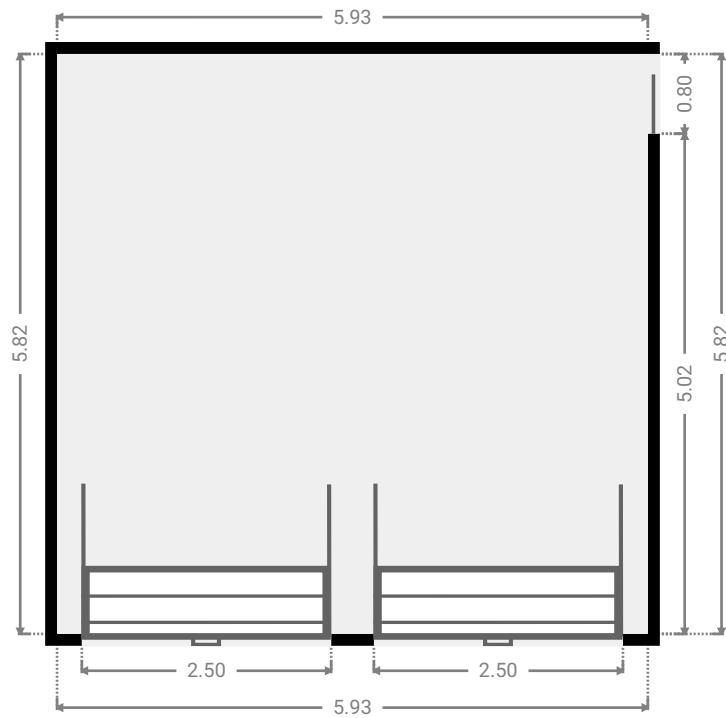
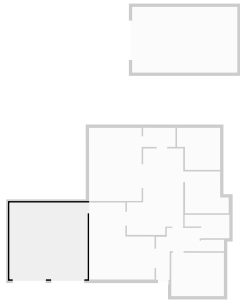

▼ **Other**
Ground Floor

WIDTH: 8.00 m • LENGTH: 5.00 m
AREA: 40.00 m² • PERIMETER: 26.00 m

