

43 Pearson Street

Created on
2020-12-03

Floors
2

▼ Ground Floor

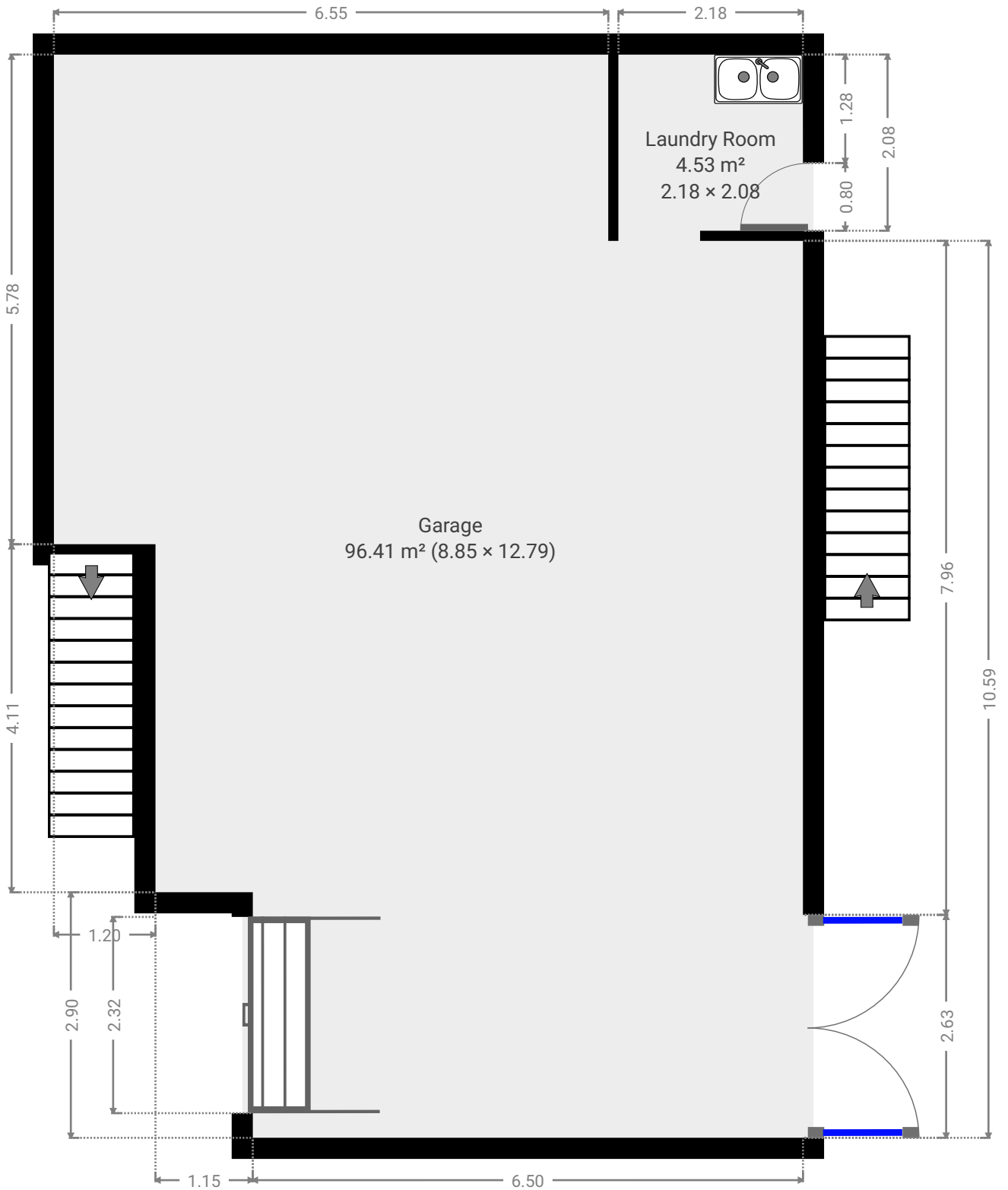

FLOORS:2

▼ **Garage**
Ground Floor

WIDTH:12.79 m · LENGTH:8.85 m
AREA:96.41 m² · PERIMETER:43.29 m

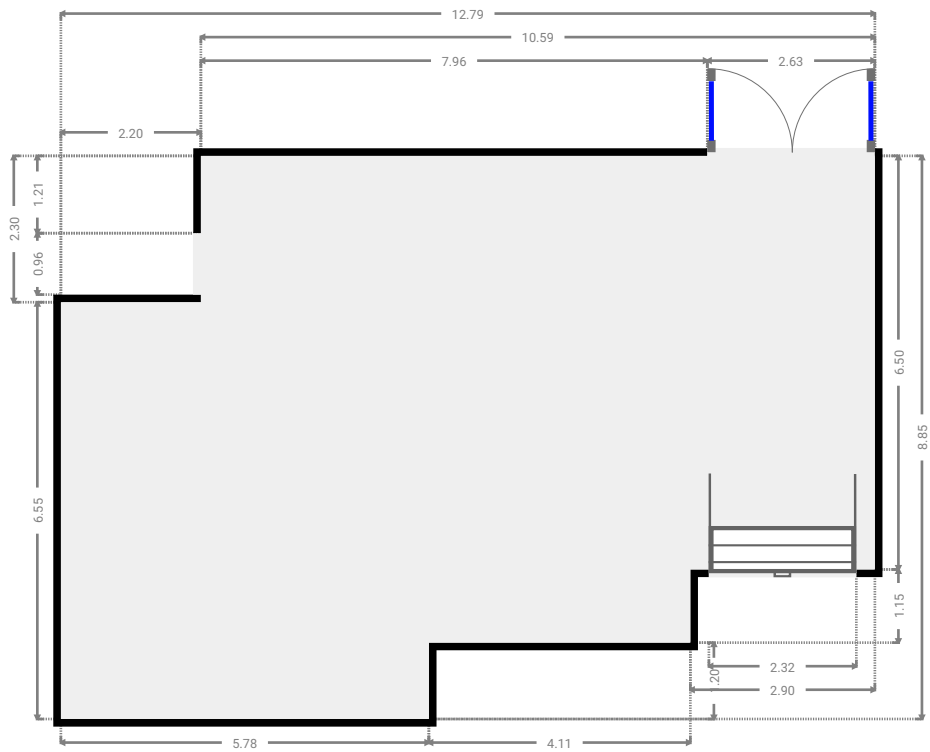
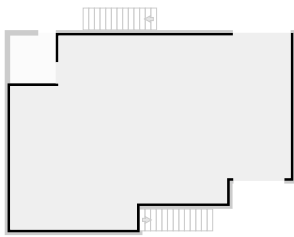

▼ **Laundry Room**
Ground Floor

WIDTH:2.08 m · LENGTH:2.18 m
AREA:4.53 m² · PERIMETER:8.52 m

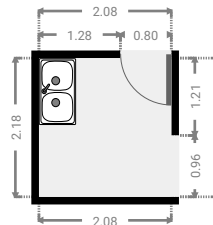
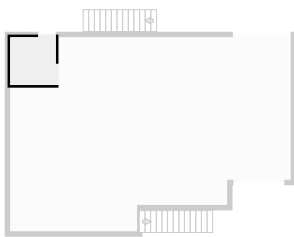

▼ 1st Floor

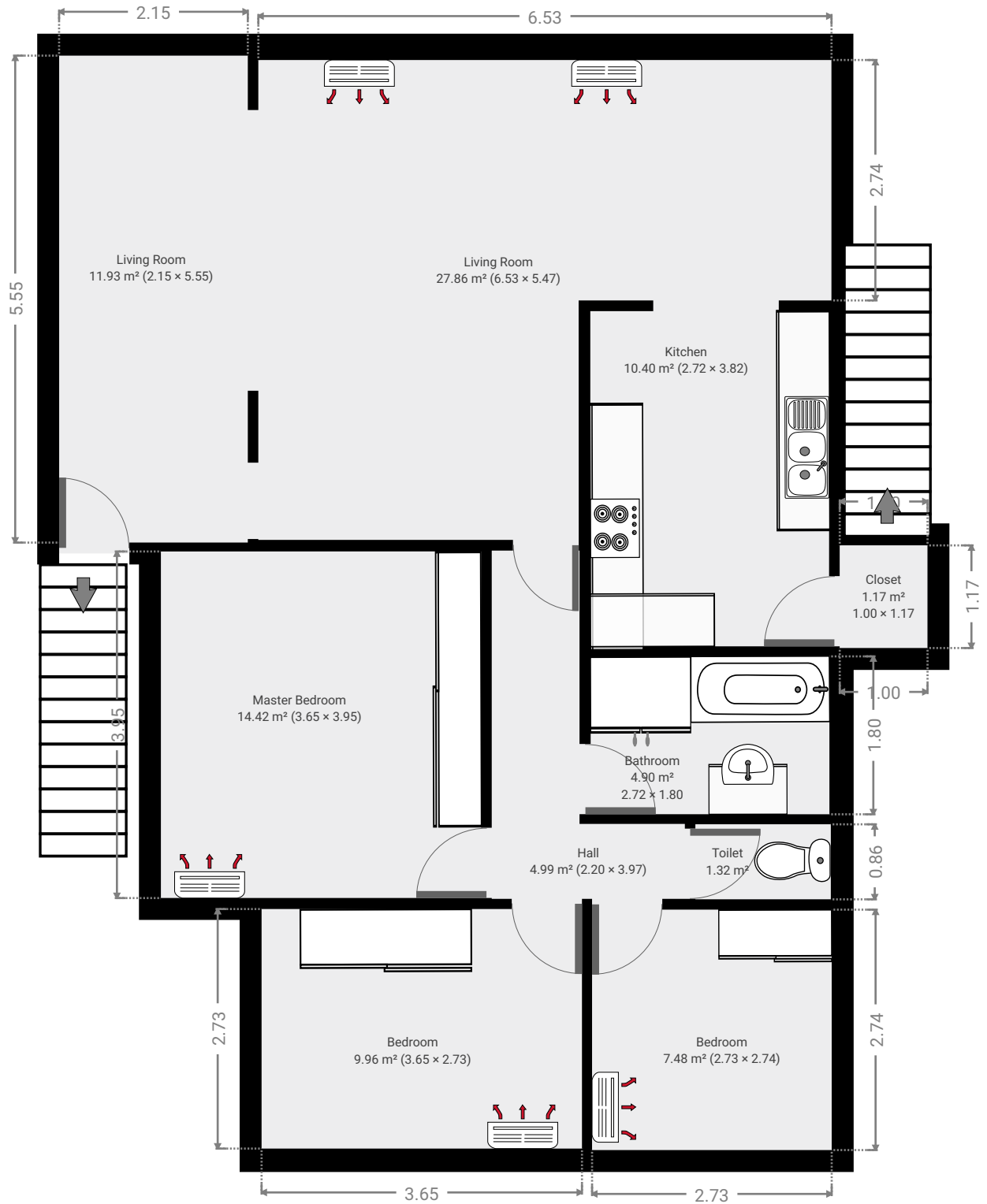

▼ Living Room
1st Floor

WIDTH:5.55 m · LENGTH:2.15 m
AREA:11.93 m² · PERIMETER:15.40 m

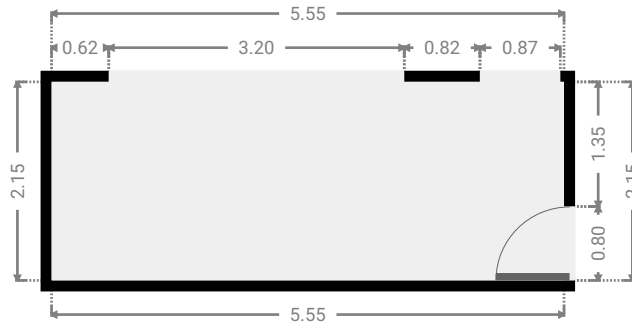

▼ Living Room
1st Floor

WIDTH:5.47 m · LENGTH:6.53 m
AREA:27.86 m² · PERIMETER:24.00 m

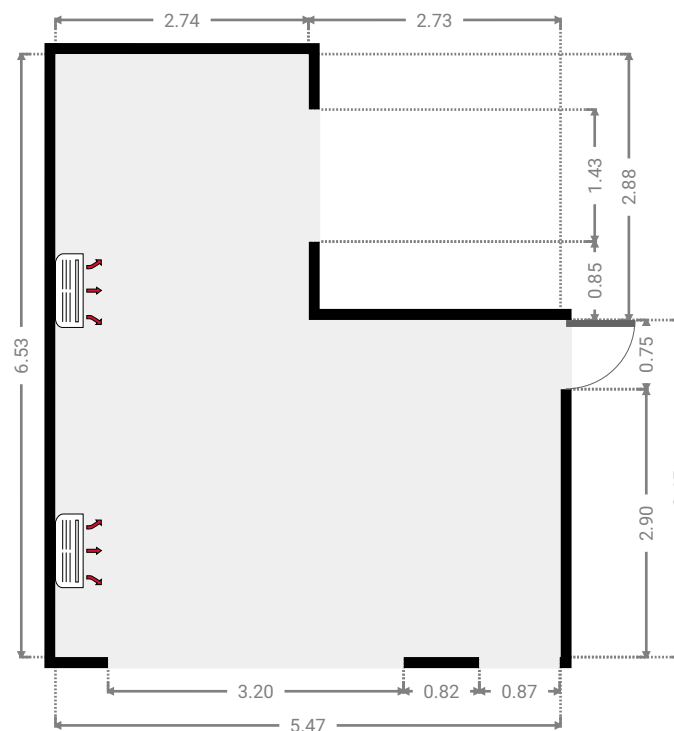
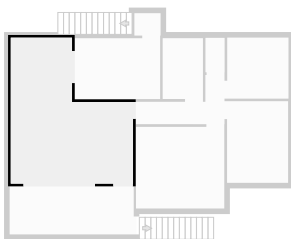

▼ Kitchen
1st Floor

WIDTH:3.82 m · LENGTH:2.72 m
AREA:10.40 m² · PERIMETER:13.08 m

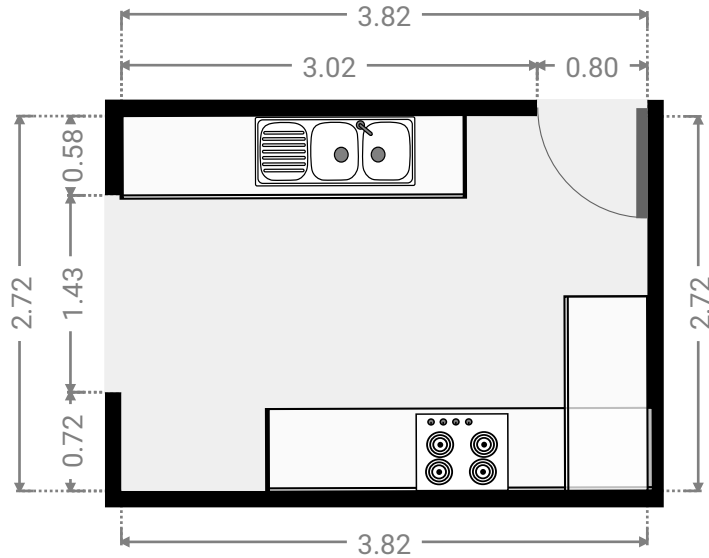
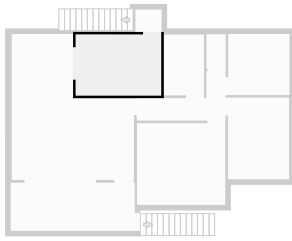

▼ Hall
1st Floor

WIDTH:3.97 m · LENGTH:2.20 m
AREA:4.99 m² · PERIMETER:12.34 m

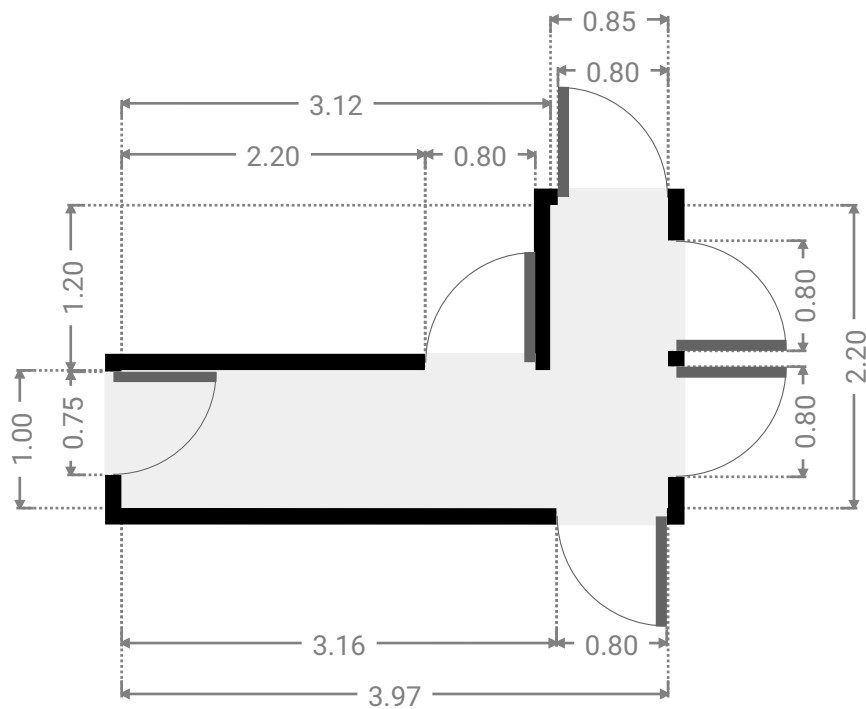
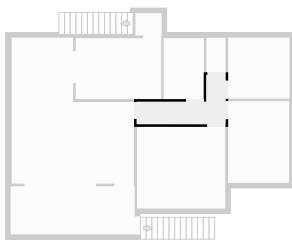

▼ Master Bedroom
1st Floor

WIDTH:3.95 m · LENGTH:3.65 m
AREA:14.42 m² · PERIMETER:15.20 m

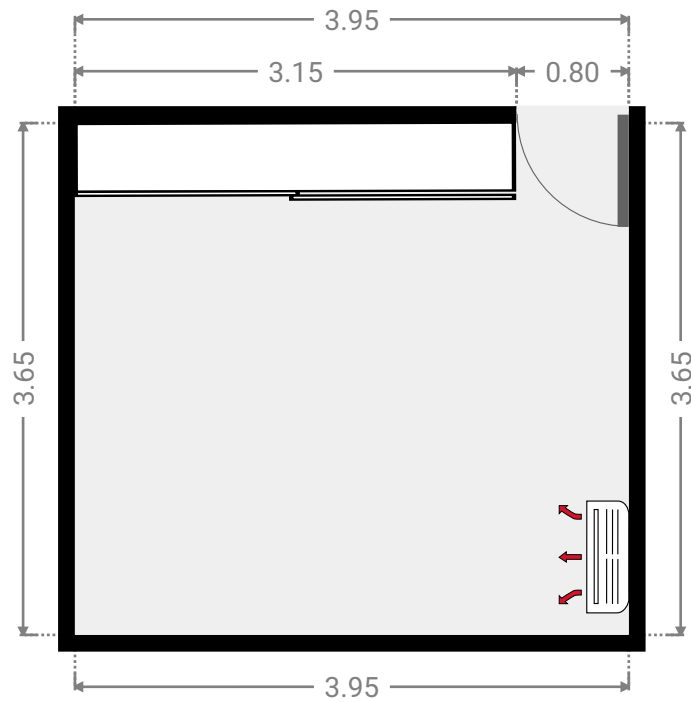
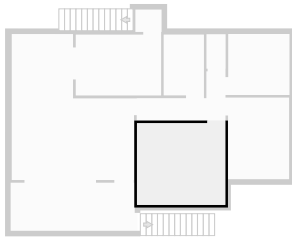

▼ Bathroom
1st Floor

WIDTH:1.80 m · LENGTH:2.72 m
AREA:4.90 m² · PERIMETER:9.04 m

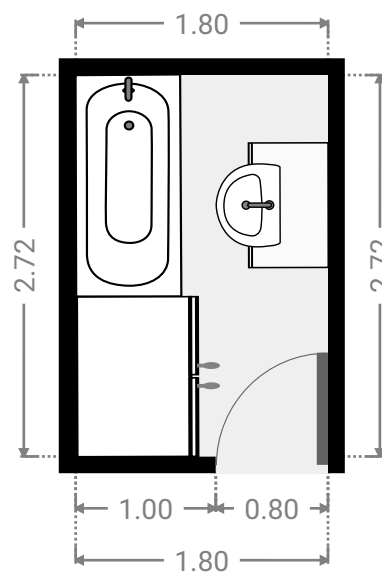
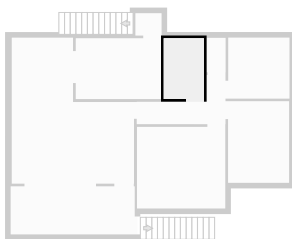

▼ **Bedroom**
1st Floor

WIDTH:2.73 m · LENGTH:3.65 m
AREA:9.96 m² · PERIMETER:12.76 m

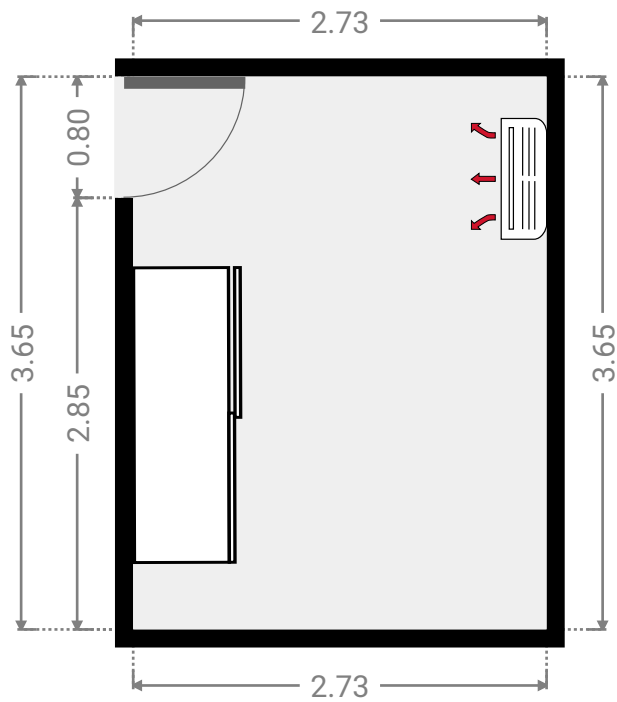
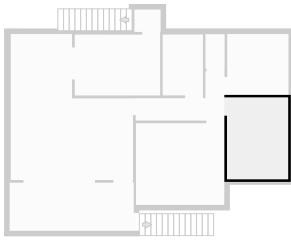

▼ **Bedroom**
1st Floor

WIDTH:2.74 m · LENGTH:2.73 m
AREA:7.48 m² · PERIMETER:10.94 m

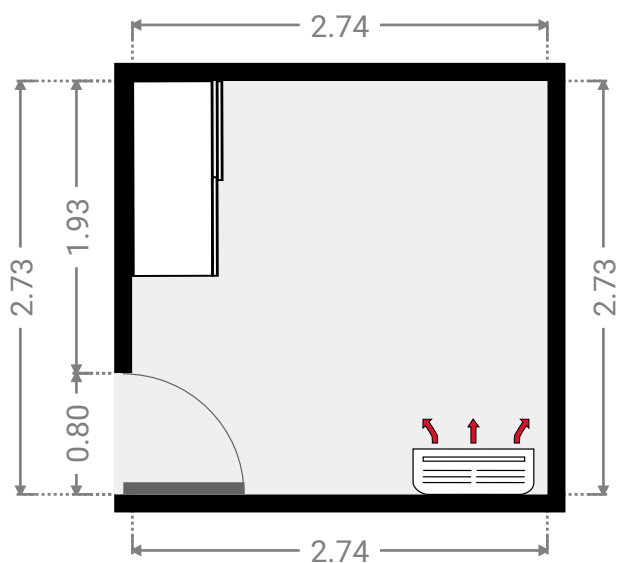
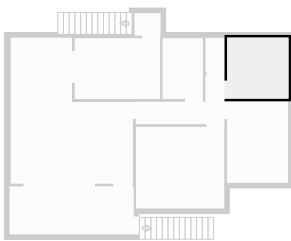

▼ Toilet
1st Floor

WIDTH:0.86 m · LENGTH:1.54 m
AREA:1.32 m² · PERIMETER:4.80 m

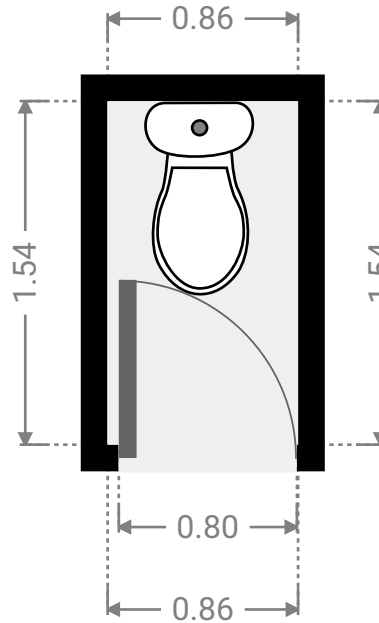
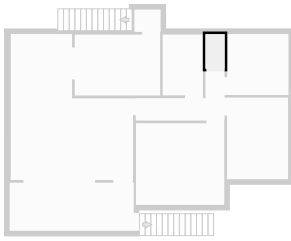

▼ Closet
1st Floor

WIDTH:1.17 m · LENGTH:1.00 m
AREA:1.17 m² · PERIMETER:4.34 m

