

# 43 Fairfield Avenue

**SUBMITTED BY**

Ray White Rockhampton Casey  
stockers@cqoz.com

---

**CREATED ON**

2022-12-21

---

**Floors**

1

---

▼ Ground Floor

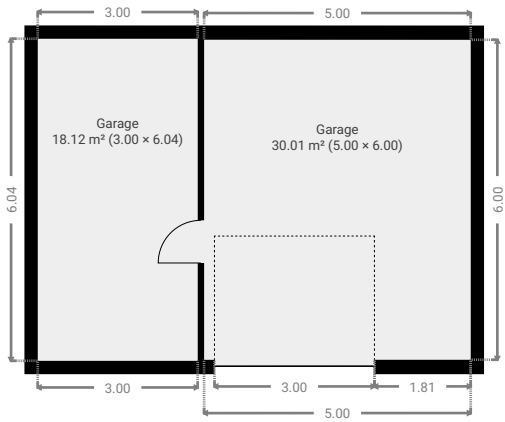

FLOORS: 1

▼ **Bathroom**  
Ground Floor

WIDTH: 3.11 m • LENGTH: 2.40 m  
AREA: 6.13 m<sup>2</sup> • PERIMETER: 11.01 m

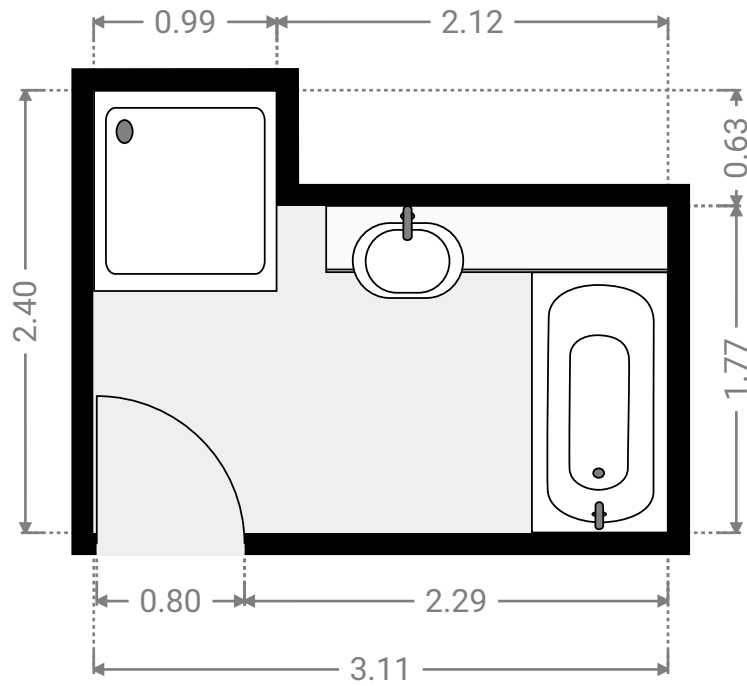
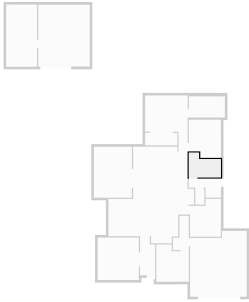

▼ **Bedroom**  
Ground Floor

WIDTH: 3.50 m • LENGTH: 2.06 m  
AREA: 7.19 m<sup>2</sup> • PERIMETER: 11.11 m

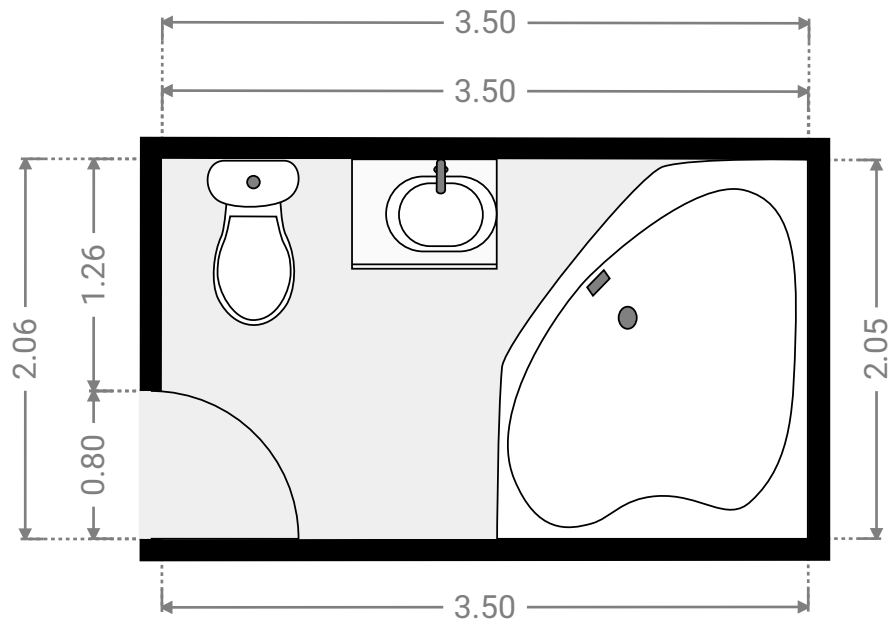
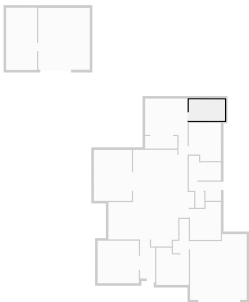

FLOORS: 1

▼ **Bedroom**  
Ground Floor

WIDTH: 3.11 m • LENGTH: 3.71 m  
AREA: 10.83 m<sup>2</sup> • PERIMETER: 13.64 m

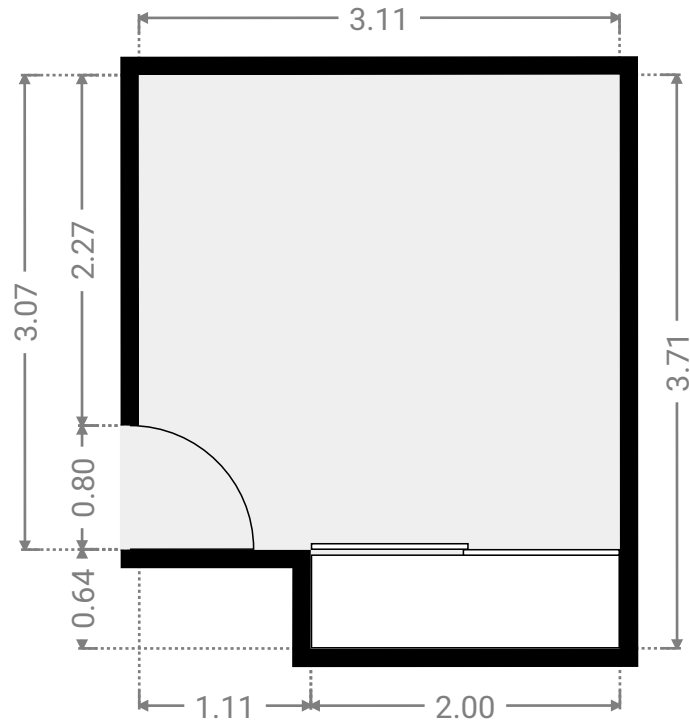
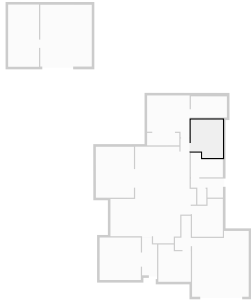

▼ **Bedroom**  
Ground Floor

WIDTH: 3.00 m • LENGTH: 3.68 m  
AREA: 10.01 m<sup>2</sup> • PERIMETER: 13.36 m

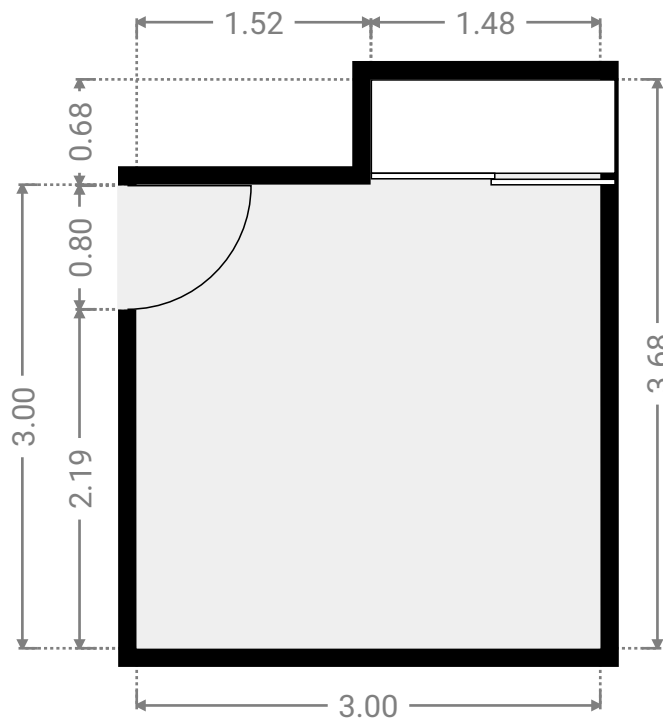
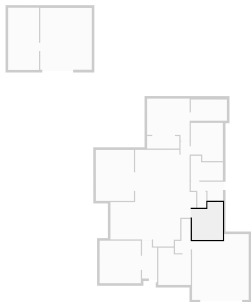

FLOORS: 1

▼ Bedroom  
Ground Floor

WIDTH: 3.16 m • LENGTH: 3.62 m  
AREA: 10.35 m<sup>2</sup> • PERIMETER: 13.56 m

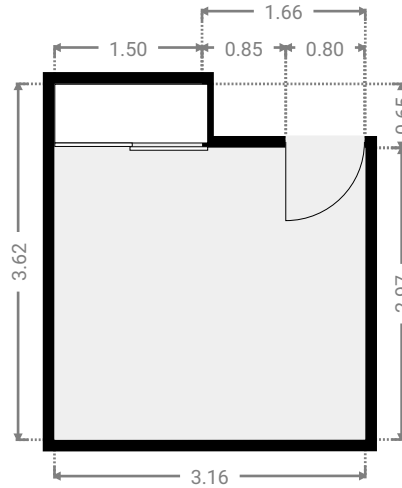
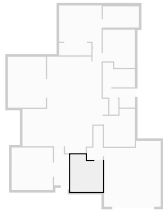

▼ Garage  
Ground Floor

WIDTH: 5.50 m • LENGTH: 6.39 m  
AREA: 33.04 m<sup>2</sup> • PERIMETER: 23.78 m

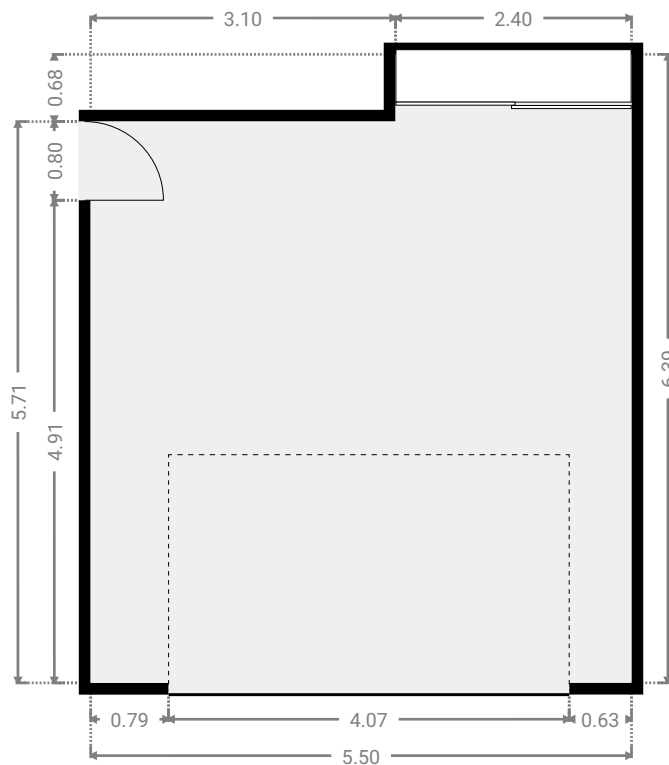
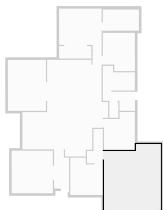

FLOORS: 1

▼ **Garage**  
Ground Floor

WIDTH: 3.00 m • LENGTH: 6.04 m  
AREA: 18.12 m<sup>2</sup> • PERIMETER: 18.08 m

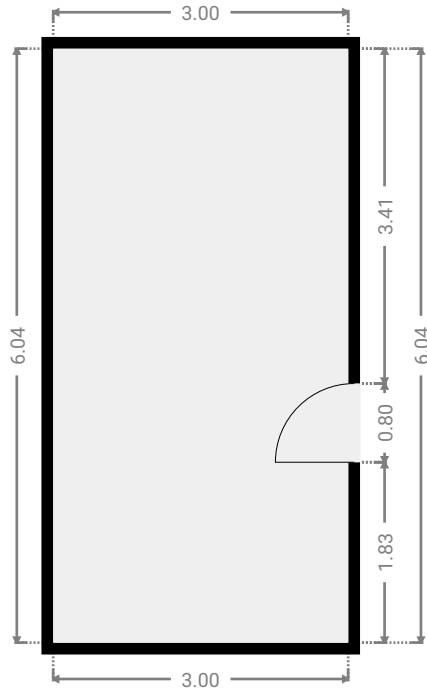
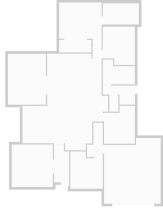

▼ **Garage**  
Ground Floor

WIDTH: 5.00 m • LENGTH: 6.00 m  
AREA: 30.01 m<sup>2</sup> • PERIMETER: 22.00 m

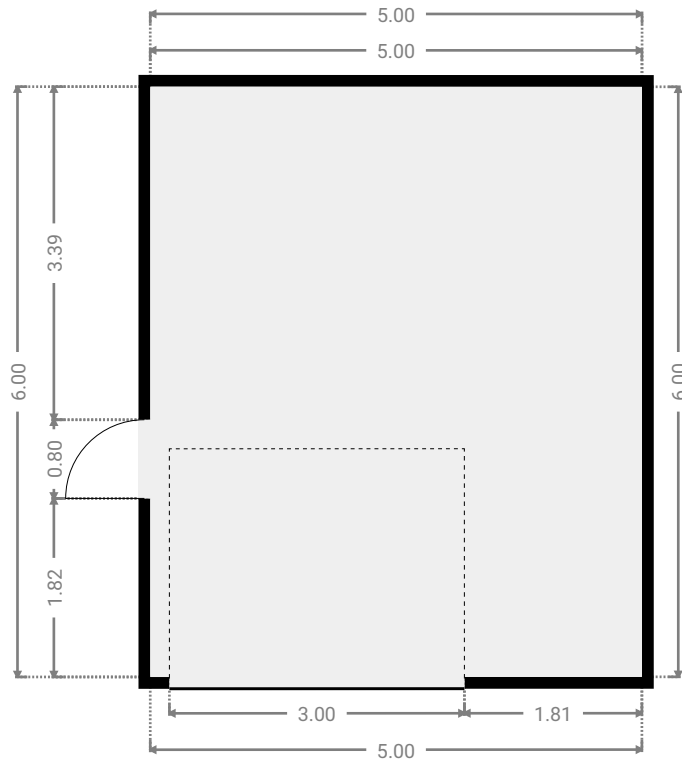
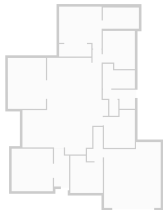

FLOORS: 1

▼ Hall  
Ground Floor

WIDTH: 1.46 m • LENGTH: 3.66 m  
AREA: 5.01 m<sup>2</sup> • PERIMETER: 10.24 m

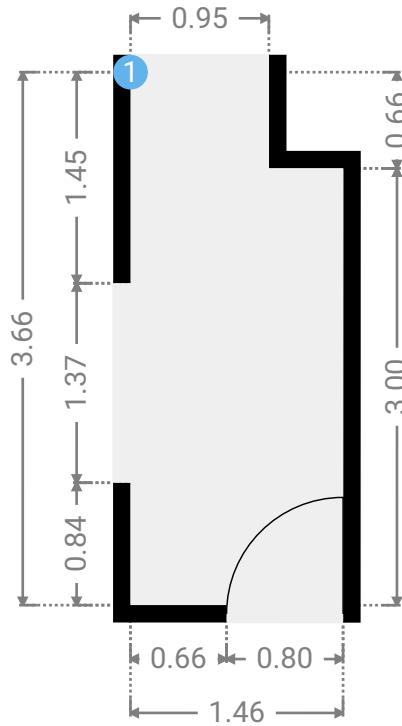
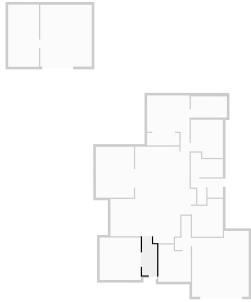

▼ Hall/Ground Floor

1 OPENING

Height  
0.00 m



FLOORS: 1

▼ **Hall**  
Ground Floor

WIDTH: 0.88 m • LENGTH: 1.29 m  
AREA: 1.14 m<sup>2</sup> • PERIMETER: 4.34 m

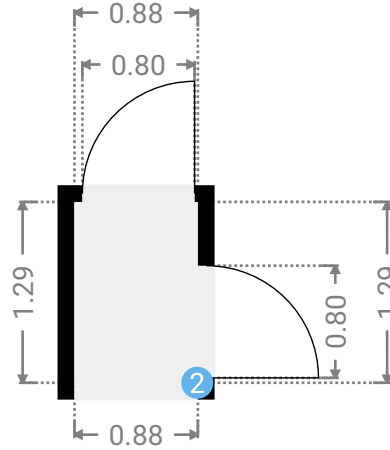
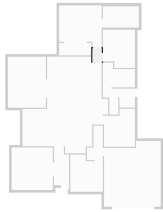

▼ **Hall**  
Ground Floor

WIDTH: 1.53 m • LENGTH: 3.33 m  
AREA: 3.77 m<sup>2</sup> • PERIMETER: 9.73 m

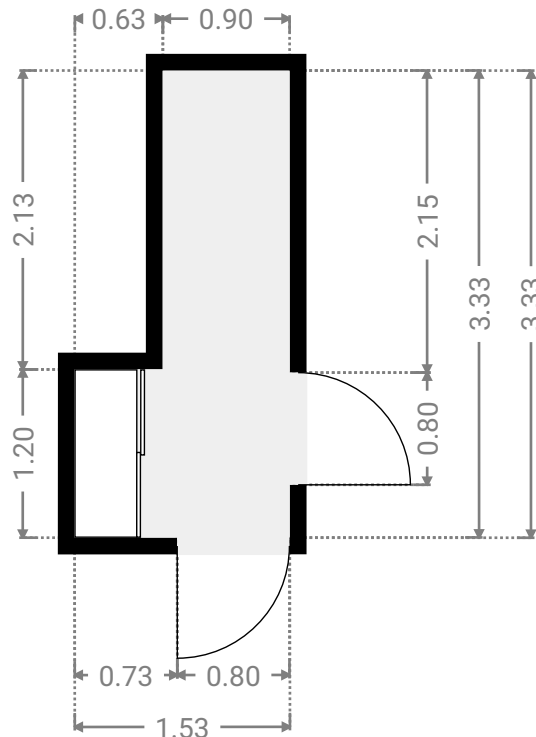
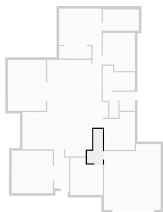



▼ **Kitchen**  
Ground Floor

WIDTH: 8.32 m • LENGTH: 9.39 m  
AREA: 54.68 m<sup>2</sup> • PERIMETER: 35.42 m

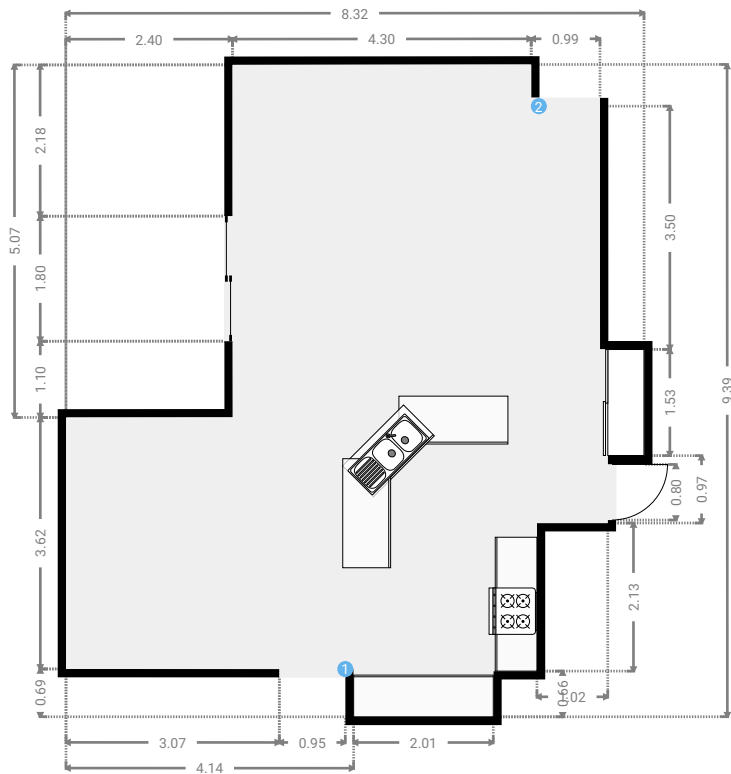
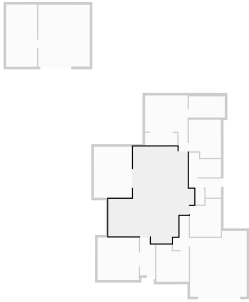

▼ **Kitchen/Ground Floor**

**2 OPENING**

Height  
0.00 m



FLOORS: 1

▼ **Laundry Room**  
Ground Floor

WIDTH: 3.12 m • LENGTH: 1.85 m  
AREA: 4.20 m<sup>2</sup> • PERIMETER: 9.94 m

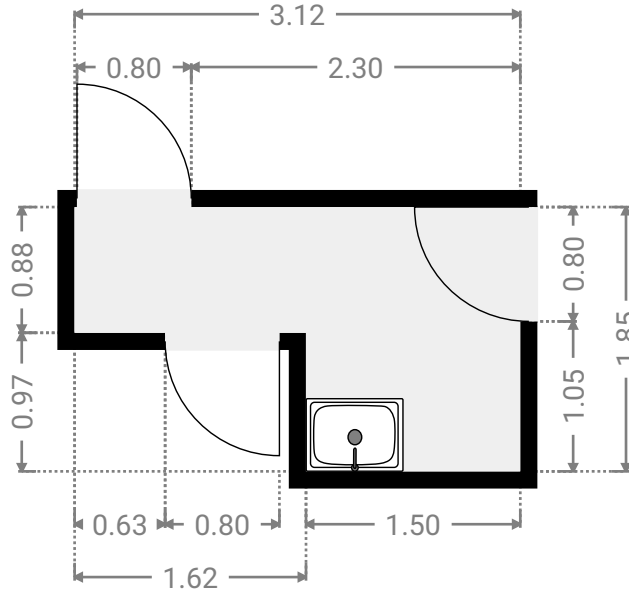
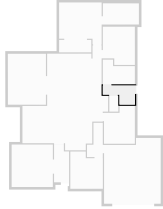

▼ **Living Room**  
Ground Floor

WIDTH: 4.00 m • LENGTH: 4.13 m  
AREA: 16.51 m<sup>2</sup> • PERIMETER: 16.25 m

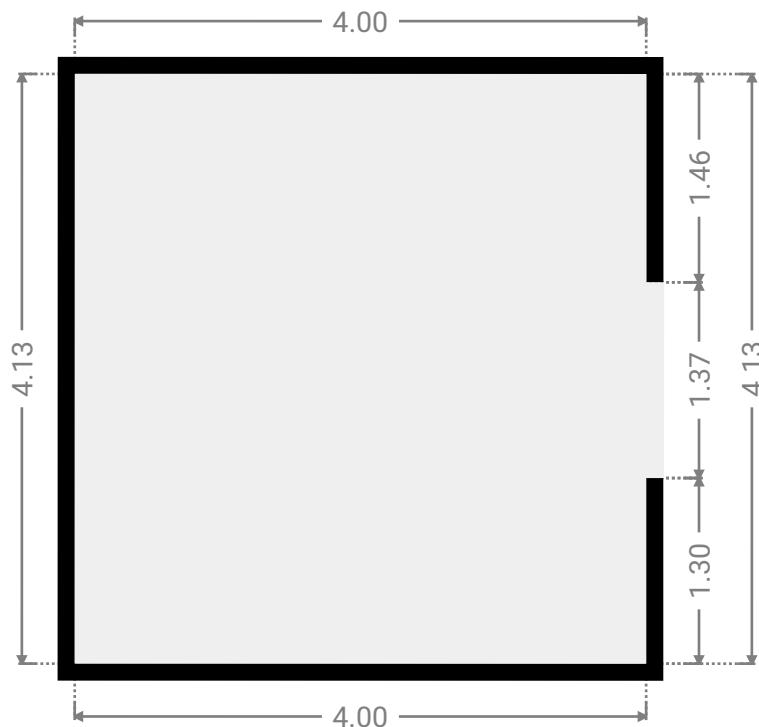
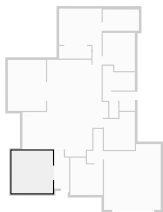

FLOORS: 1

▼ **Other**  
Ground Floor

WIDTH: 3.71 m • LENGTH: 4.95 m  
AREA: 18.28 m<sup>2</sup> • PERIMETER: 17.28 m

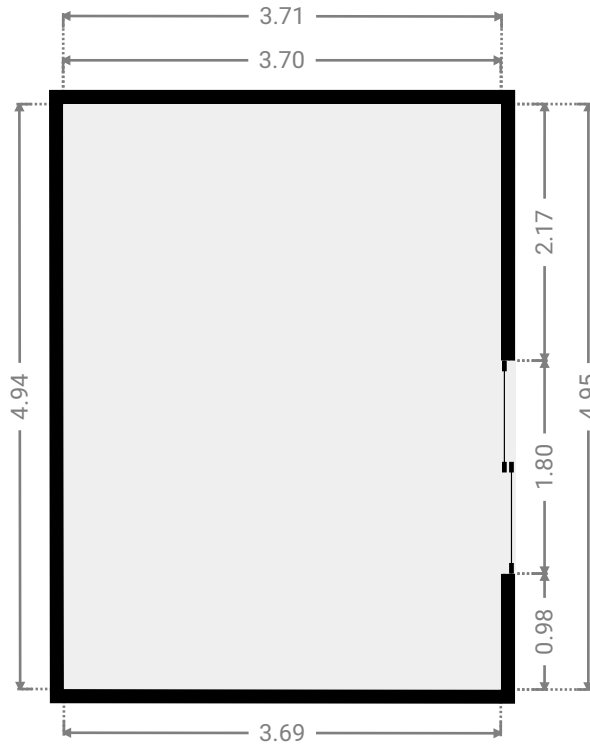
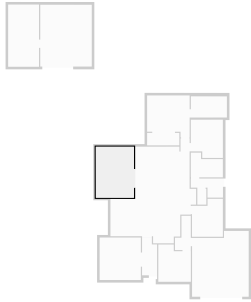

▼ **Primary Bedroom**  
Ground Floor

WIDTH: 4.13 m • LENGTH: 4.08 m  
AREA: 15.03 m<sup>2</sup> • PERIMETER: 16.42 m

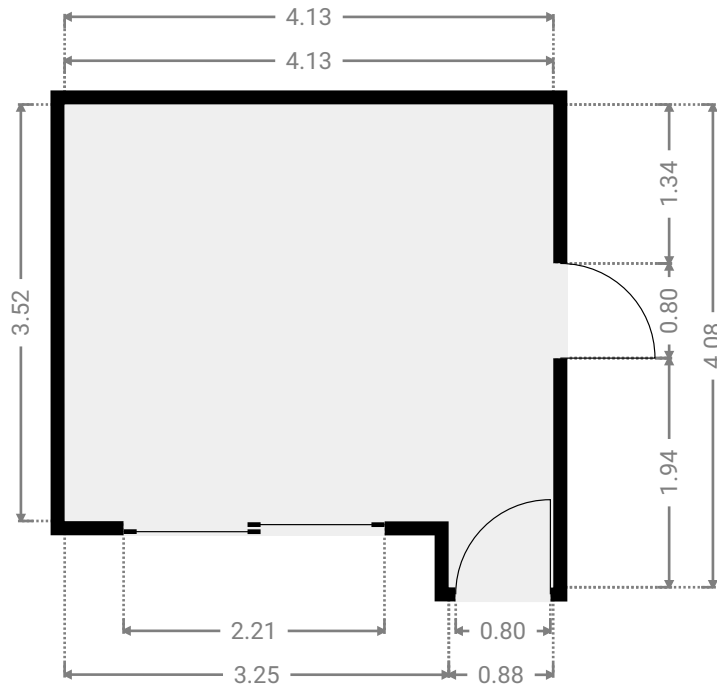
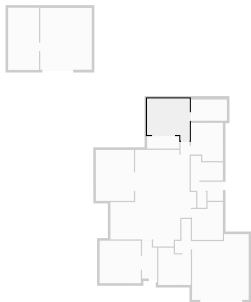

FLOORS: 1

▼ **Closet**  
Ground Floor

WIDTH: 3.13 m • LENGTH: 1.21 m  
AREA: 3.78 m<sup>2</sup> • PERIMETER: 8.67 m

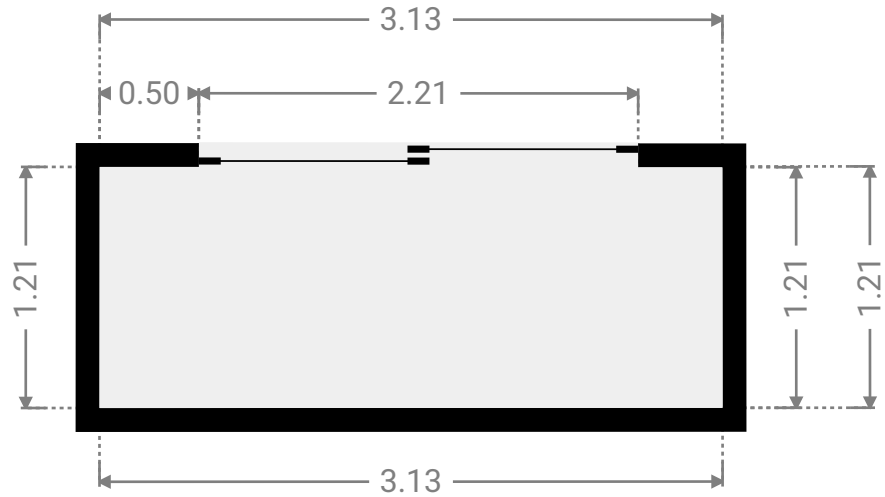
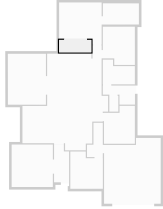

▼ **Toilet**  
Ground Floor

WIDTH: 0.87 m • LENGTH: 1.53 m  
AREA: 1.33 m<sup>2</sup> • PERIMETER: 4.80 m

