

246 Thozet Road

Ground Floor

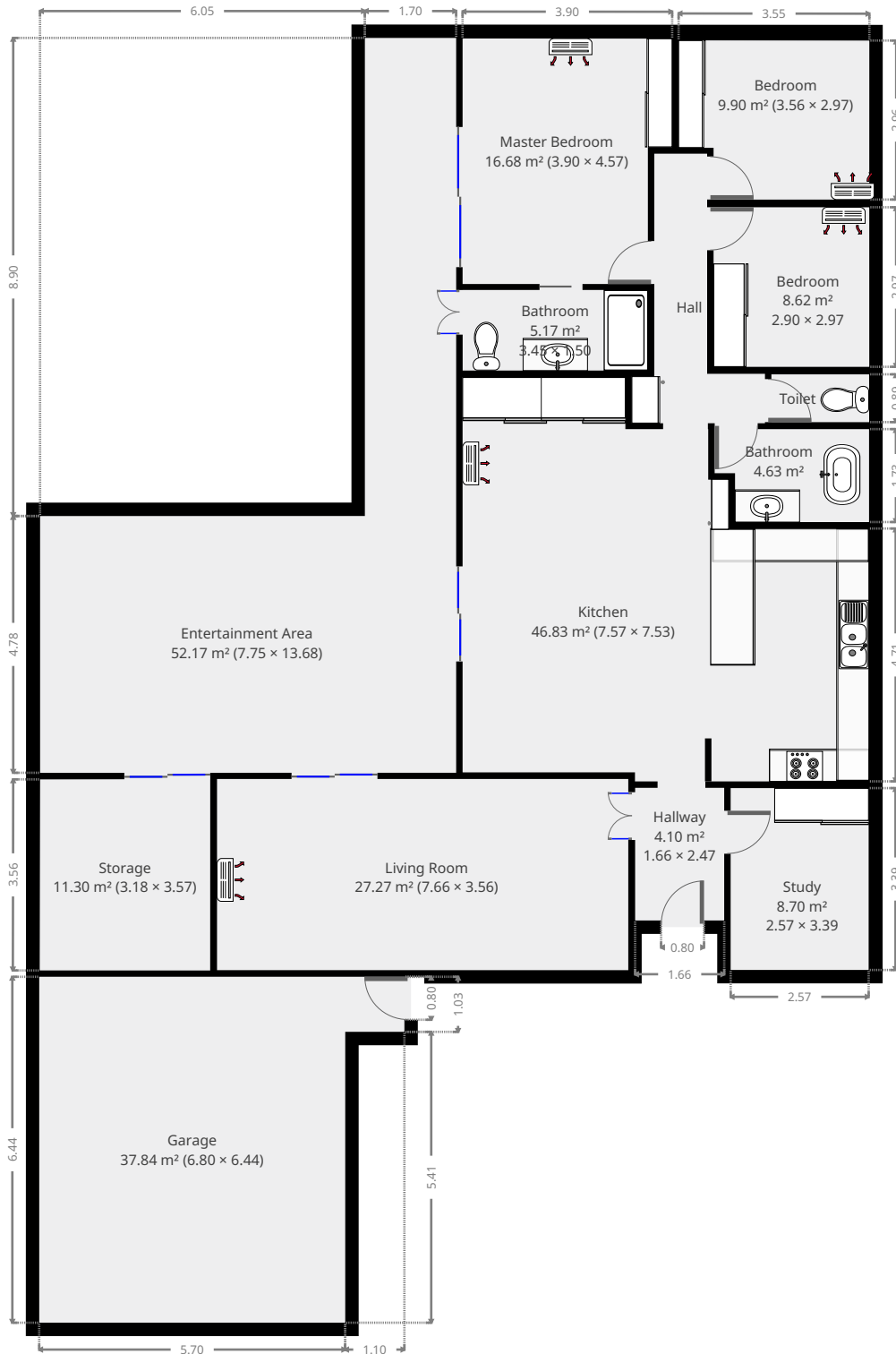

THIS FLOORPLAN IS PROVIDED WITHOUT WARRANTY OF ANY KIND. SENSOPIA DISCLAIMS ANY WARRANTY INCLUDING, WITHOUT LIMITATION, SATISFACTORY QUALITY OR ACCURACY OF DIMENSIONS.



246 Thozet Road

Hallway

Width: 1.66 m
Length: 2.47 m
Area: 4.10 m²
Perimeter: 8.26 m

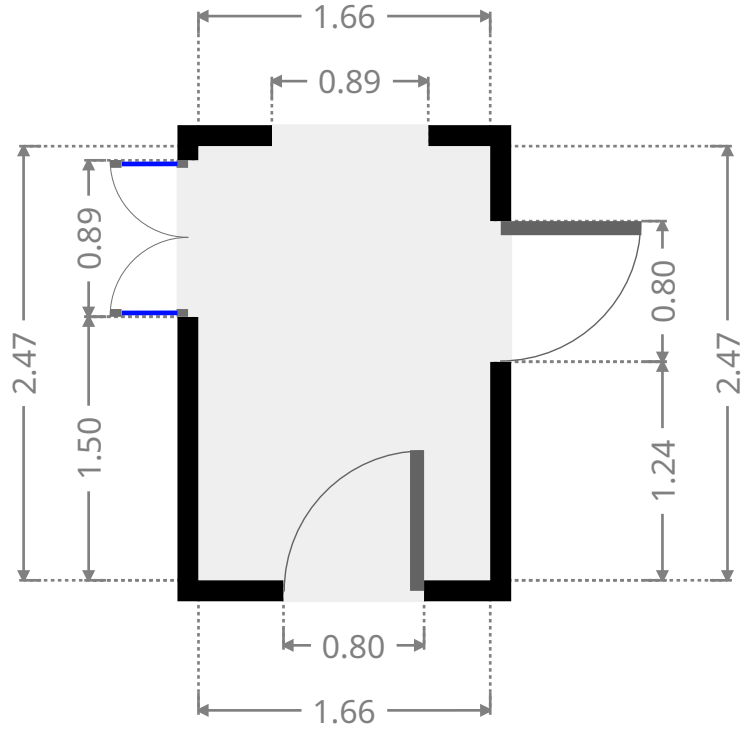
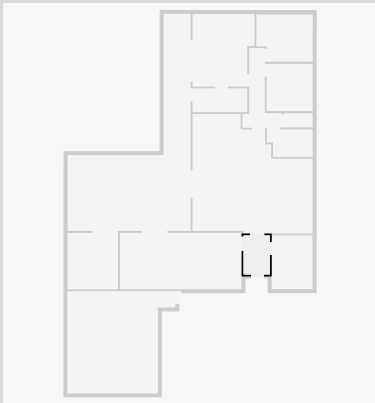

Study

Width: 2.57 m
Length: 3.39 m
Area: 8.70 m²
Perimeter: 11.91 m

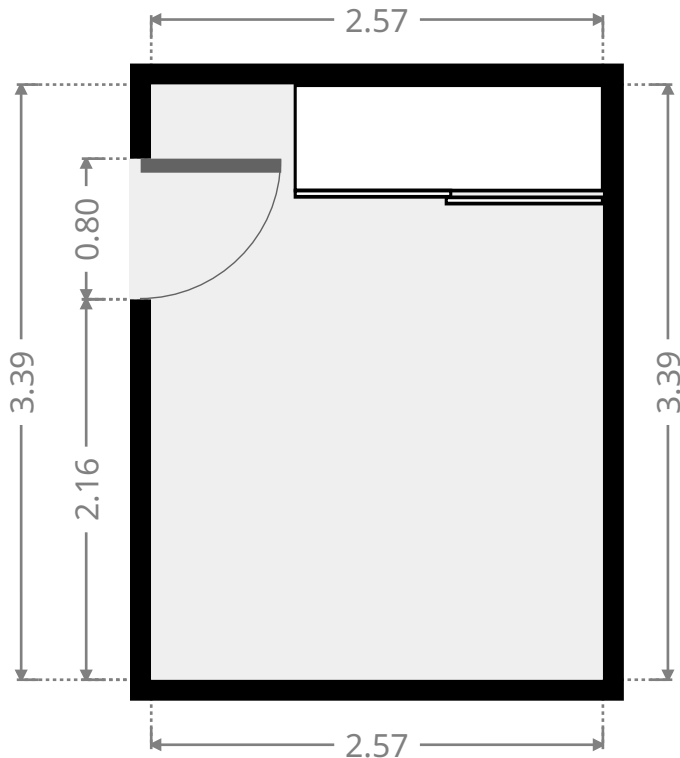
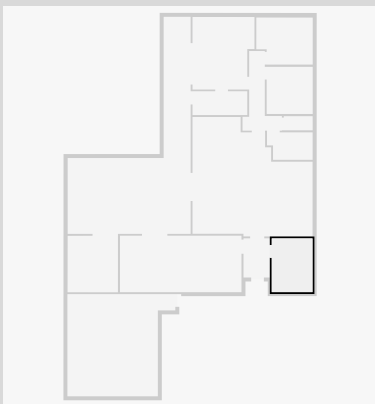

246 Thozet Road

Living Room

Width: 3.56 m
 Length: 7.66 m
 Area: 27.27 m²
 Perimeter: 22.44 m

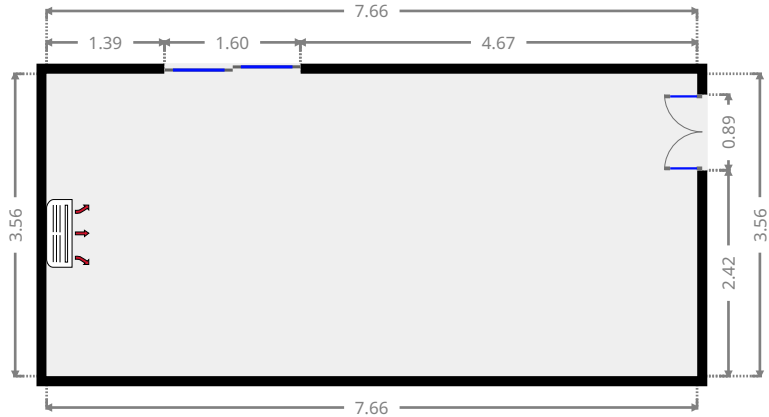
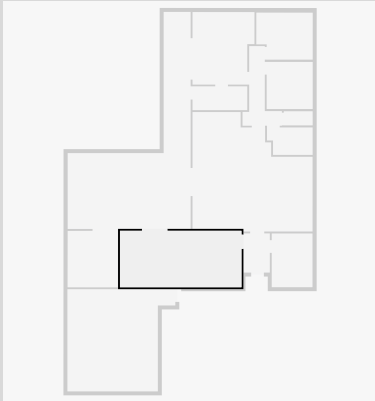

Kitchen

Width: 7.53 m
 Length: 7.57 m
 Area: 46.83 m²
 Perimeter: 30.19 m

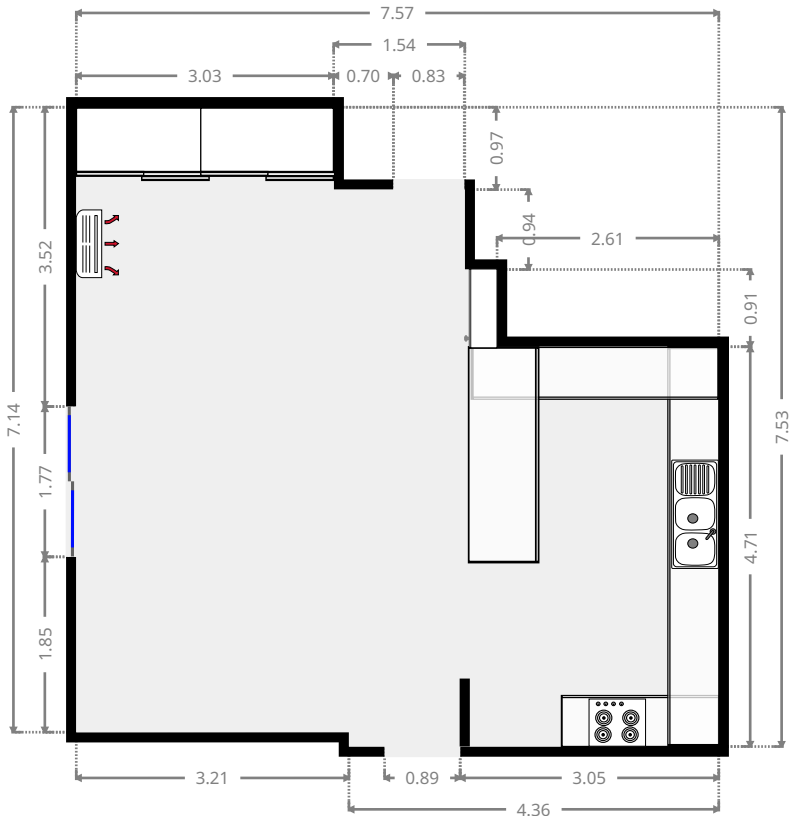
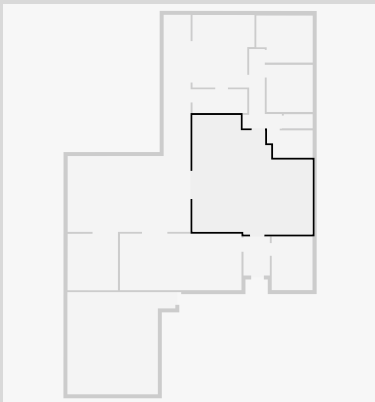

THIS FLOORPLAN IS PROVIDED WITHOUT WARRANTY OF ANY KIND. SENSOPIA DISCLAIMS ANY WARRANTY INCLUDING, WITHOUT LIMITATION, SATISFACTORY QUALITY OR ACCURACY OF DIMENSIONS.

246 Thozet Road

Hall

Width: 2.48 m
Length: 5.02 m
Area: 6.30 m²
Perimeter: 15.00 m

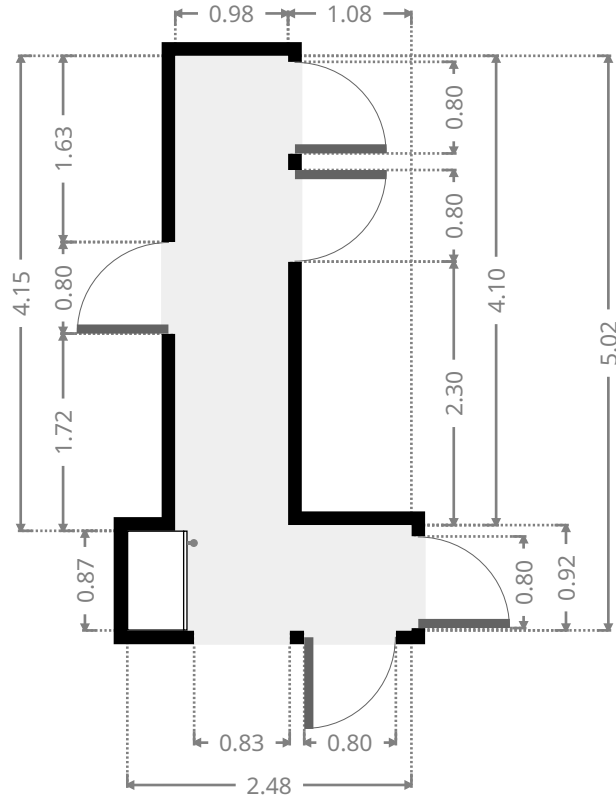
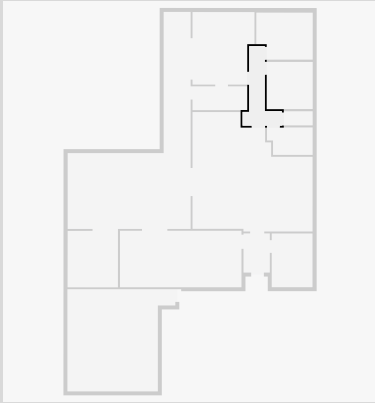

Bathroom

Width: 1.73 m
Length: 2.88 m
Area: 4.63 m²
Perimeter: 9.21 m

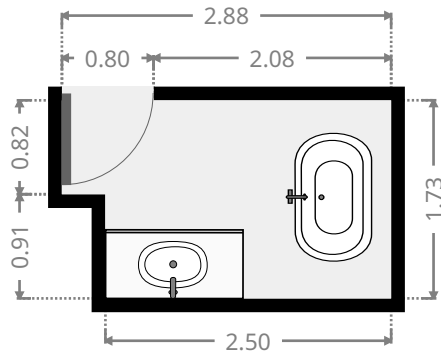
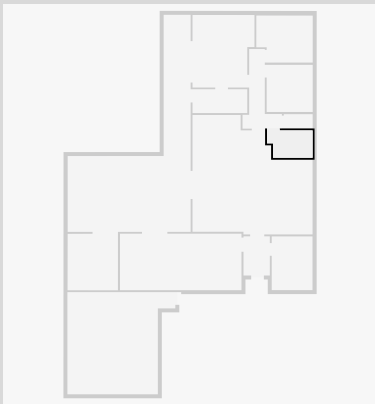

246 Thozet Road

Toilet / Half Bath

Width: 0.89 m
Length: 1.82 m
Area: 1.62 m²
Perimeter: 5.42 m

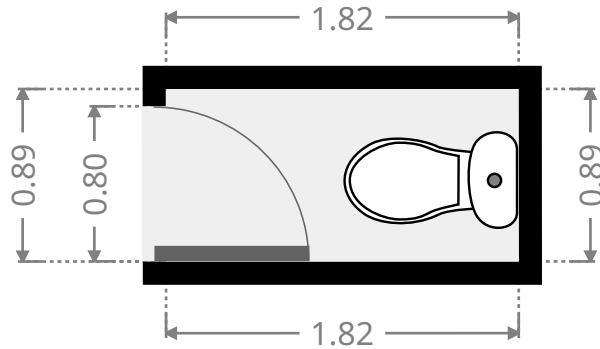
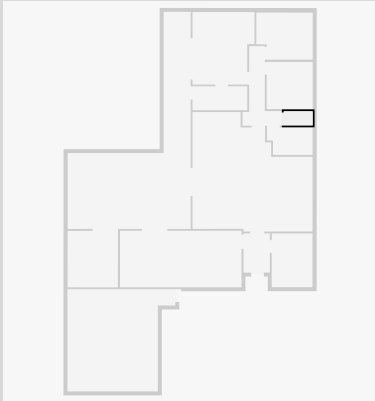

Bedroom

Width: 2.90 m
Length: 2.97 m
Area: 8.62 m²
Perimeter: 11.74 m

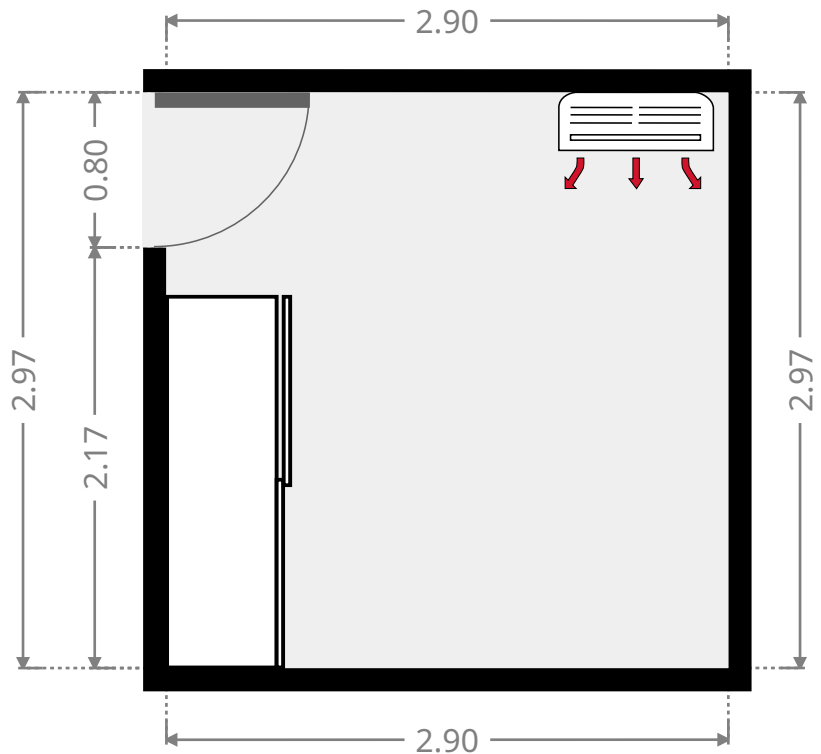
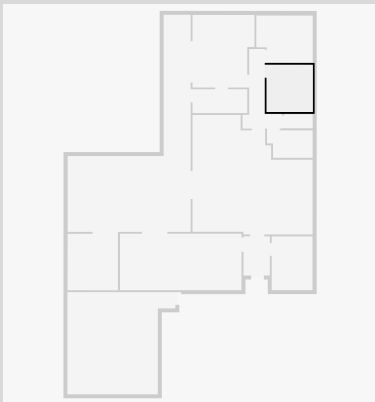

246 Thozet Road

Bedroom

Width: 2.97 m
 Length: 3.56 m
 Area: 9.90 m²
 Perimeter: 13.03 m

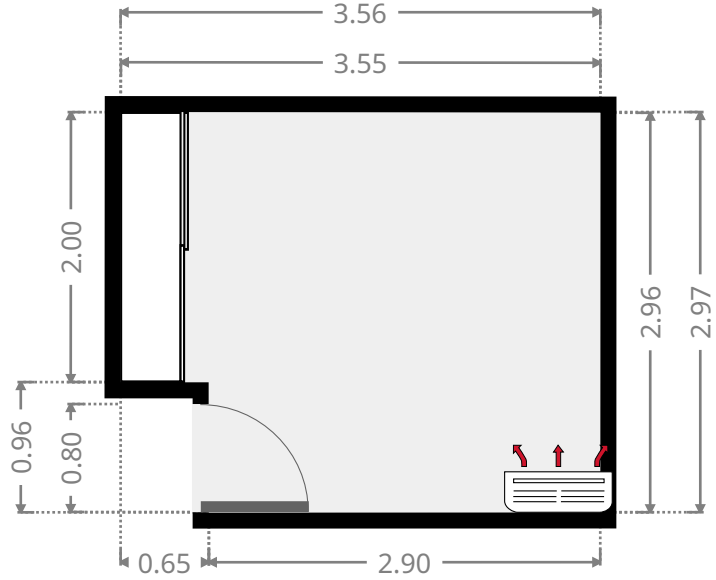
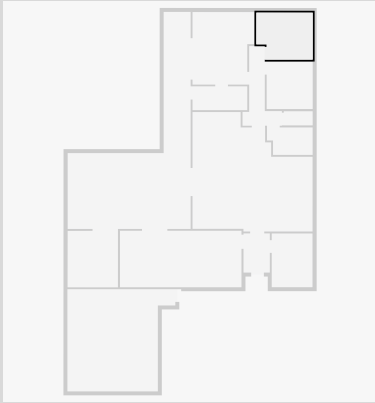

Master Bedroom

Width: 3.90 m
 Length: 4.57 m
 Area: 16.68 m²
 Perimeter: 16.95 m

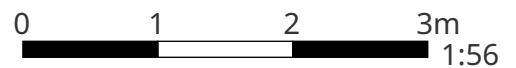
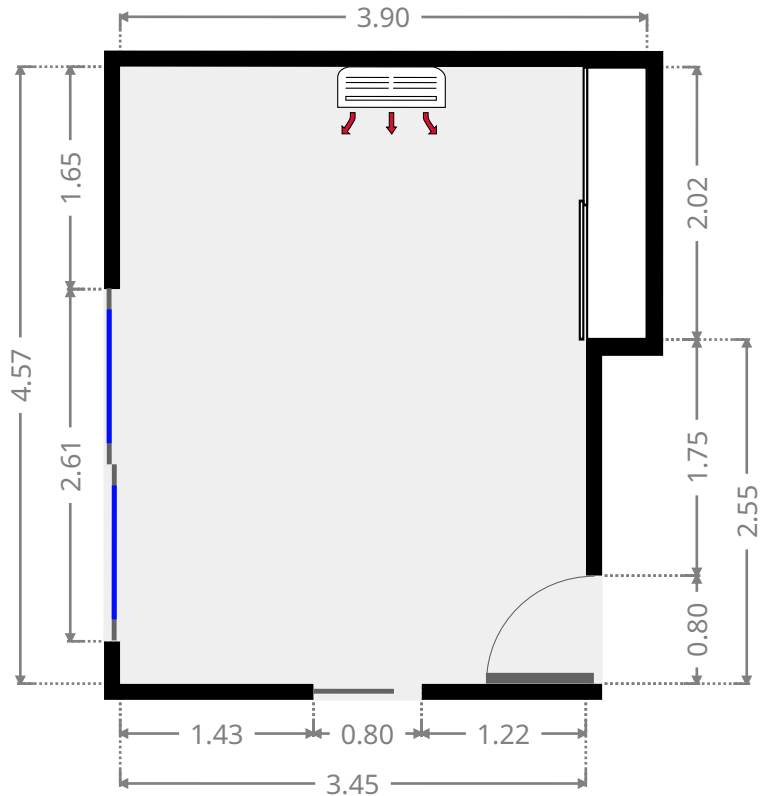
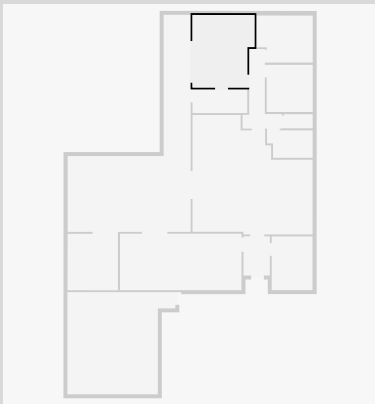

THIS FLOORPLAN IS PROVIDED WITHOUT WARRANTY OF ANY KIND. SENSOPIA DISCLAIMS ANY WARRANTY INCLUDING, WITHOUT LIMITATION, SATISFACTORY QUALITY OR ACCURACY OF DIMENSIONS.

246 Thozet Road

Bathroom

Width: 1.50 m
Length: 3.45 m
Area: 5.17 m²
Perimeter: 9.90 m

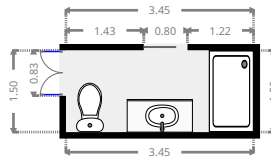
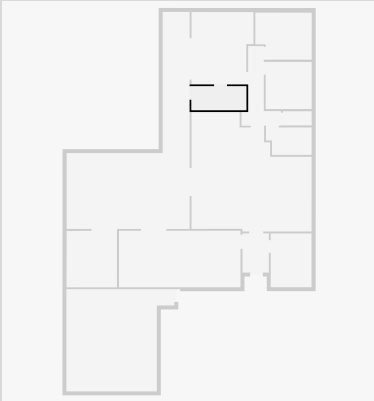

Entertainment Area

Width: 7.75 m
Length: 13.68 m
Area: 52.17 m²
Perimeter: 42.86 m

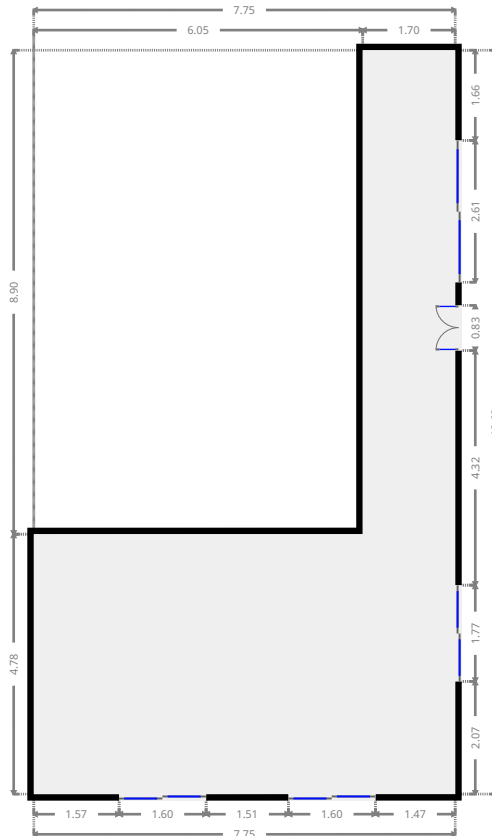
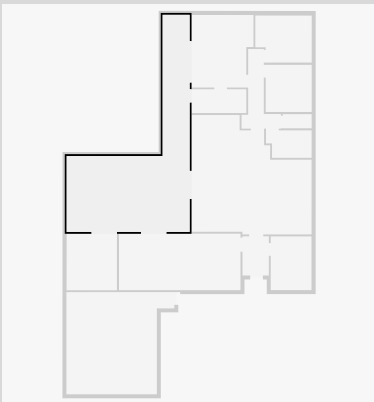

THIS FLOORPLAN IS PROVIDED WITHOUT WARRANTY OF ANY KIND. SENSOPIA DISCLAIMS ANY WARRANTY INCLUDING, WITHOUT LIMITATION, SATISFACTORY QUALITY OR ACCURACY OF DIMENSIONS.

246 Thozet Road

Storage

Width: 3.18 m
Length: 3.57 m
Area: 11.30 m²
Perimeter: 13.47 m

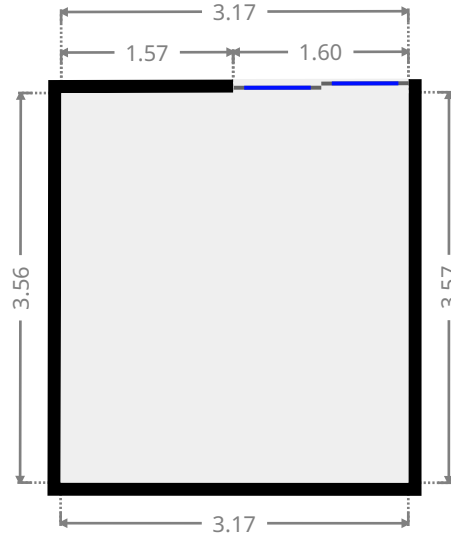
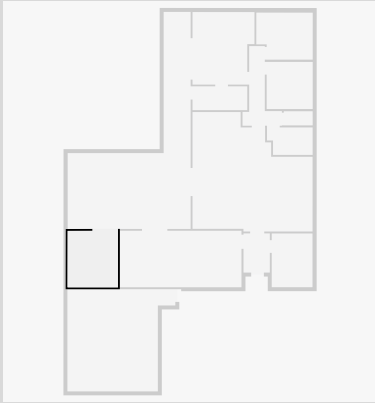

Garage

Width: 6.44 m
Length: 6.80 m
Area: 37.84 m²
Perimeter: 26.48 m

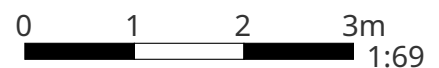
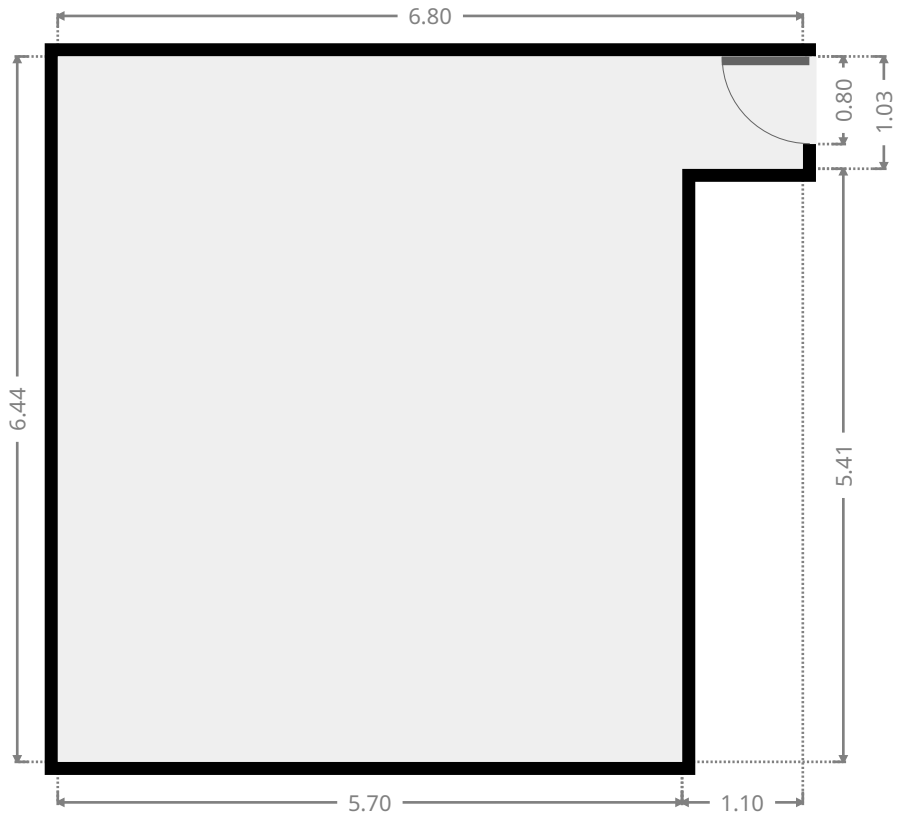
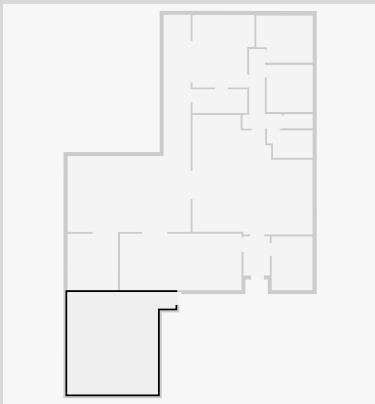

THIS FLOORPLAN IS PROVIDED WITHOUT WARRANTY OF ANY KIND. SENSOPIA DISCLAIMS ANY WARRANTY INCLUDING, WITHOUT LIMITATION, SATISFACTORY QUALITY OR ACCURACY OF DIMENSIONS.